

SIEMENS



SINAMICS G180

Converters – Compact Units, Cabinet Systems,
Cabinet Units Air-Cooled and Liquid-Cooled

















SINAMICS Drives

Catalog
D 18.1

Edition
2014

Answers for industry.

Related catalogs

<p>SINAMICS G130 D 11 Drive Converter Chassis Units SINAMICS G150 Drive Converter Cabinet Units E86060-K5511-A101-A5-7600</p>		<p>LOHER Explosion-proof motors Fin-cooled motors for the oil, gas, Chemical and petrochemical industries Loher CHEMSTAR, Loher VARIO (Brochure) E20001-A30-P580-V3-7600</p>	
<p>SINAMICS GM150/SINAMICS SM150 D 12 Medium-Voltage Converters E86060-K5512-A101-A3-7600</p>		<p>LOHER Drive Systems Inherently rugged: Tailor-made drive Solutions for extreme applications (Brochure) E20001-A50-P580-X-7600</p>	
<p>SINAMICS S120 D 21.3 Chassis Format Units and Cabinet Modules SINAMICS S150 Converter Cabinet Units E86060-K5521-A131-A3-7600</p>		<p>LOHER Water-cooled motors Low-voltage motors with increased power density (Brochure) E20001-A60-P580-V1-7600</p>	
<p>Motion Control Drives D 31 SINAMICS and Motors for Single-Axis Drives E86060-K5531-A101-A1-7600 E86060-E5531-A101-A1-7600 (News)</p>		<p>LOHER Water-jacket cooled motors The ideal drive solution for oil rig (Brochure) E20001-A70-P580-X-7600</p>	
<p>Motion Control PM 21 SIMOTION, SINAMICS S120 & SIMOTICS Equipment for Production Machines E86060-K4921-A101-A3-7600</p>		<p>Motors H-compact Maximum power, minimum size (Brochure) E20001-A180-P530-X-7600</p>	
<p>SIMOTICS Low-Voltage Motors D 81.1 Type series 1LE1, 1MB1 and 1PC1 Frame sizes 80 to 315 Power range 0.3 to 250 kW E86060-K5581-A111-A6-7600</p>		<p>Motors H-compact PLUS Compact, flexible, highest availability (Brochure) E20001-A190-P530-X-7600</p>	
<p>Low-Voltage Power Distribution and Electrical Installation Technology LV 10 SENTRON • SIVACON • ALPHA Protection, Switching, Measuring and Monitoring Devices, Switchboards and Distribution Systems E86060-K8280-A101-A1-7600</p>		<p>Products for Automation and Drives CA 01 Interactive Catalog, DVD E86060-D4001-A510-D3-7600</p>	
<p>Three-Phase Induction Motors D 84.1 SIMOTICS HV, SIMOTICS TN • Series H-compact • Series H-compact PLUS E86060-K5584-A111-A4-7600</p>		<p>Industry Mall Information and Ordering Platform in the Internet: www.siemens.com/industrymall</p>	

SINAMICS Drives

SINAMICS G180

Converters – Compact Units, Cabinet Systems, Cabinet Units

Catalog D 18.1 · 2014



The products and systems described in this catalog are manufactured/distributed under application of a certified quality management system in accordance with DIN EN ISO 9001 (Certified Registration No. 002241 QM08). The certificate is recognized by all IQNet countries.

Supersedes:
Catalog D 18.1 · 2013 (PDF)

Refer to the Industry Mall for current updates of this catalog:

www.siemens.com/industrymall

The products contained in this catalog can also be found in the Interactive Catalog CA 01.

Article No.:
E86060-D4001-A510-D3-7600

Please contact your local Siemens branch

© Siemens AG 2014

Introduction	1
SINAMICS G180 compact units and SINAMICS G180 cabinet systems	2
SINAMICS G180 cabinet units Cabinet units air-cooled Cabinet units liquid-cooled	3
Option descriptions Standard options, Inspection options, Engineer To Order – ETO	4
Configuring instructions Functions, Characteristic curves, Standard interface, Communication, Type plate, Supplementary Supply Agreements, Engineering and commissioning tools, DT Configurator	5
Services and documentation Customer training, Commissioning, Maintenance, Inspection, Repairs, Spare parts, Remote maintenance, Documentation, Service & Support, Industry Services for the entire life cycle	6
Appendix Partners, Online Services, Subject index, Article number index, Conditions of sale and delivery, Export regulations	7



Printed on paper from sustainably managed forests and controlled sources.

www.pefc.org

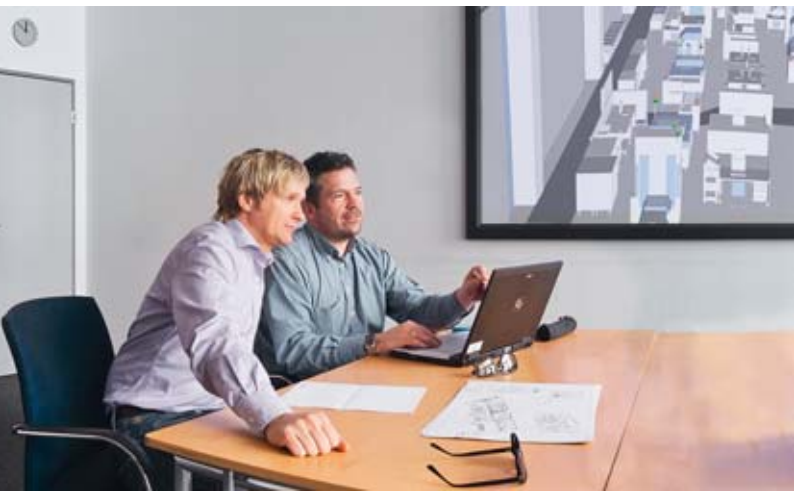



Answers for industry.

Integrated technologies, vertical market expertise and services for greater productivity, energy efficiency, and flexibility.

The Siemens Industry Sector is the world's leading supplier of innovative and environmentally friendly products and solutions for industrial companies. End-to-end automation technology and industrial software, solid market expertise, and technology-based services are the levers we use to increase our customers' productivity, efficiency and flexibility. With a global workforce of more than 100 000 employees, the Industry Sector comprises the Industry Automation, Drive Technologies, and Customer Services divisions, as well as the Metals Technologies Business Unit.

We consistently rely on integrated technologies and, thanks to our bundled portfolio, we can respond more quickly and flexibly to our customers' wishes. With our globally unmatched range of automation technology, industrial control and drive technology as well as industrial software, we equip companies with exactly what they need over their entire value chain – from product design and development to production, sales and service. Our industrial customers benefit from our comprehensive portfolio, which is tailored to their market and their needs.

Market launch times can be reduced by up to 50% due to the combination of powerful automation technology and intelligent industrial software from Siemens Industry. At the same time, the costs for energy or waste water for a manufacturing company can be reduced significantly. In this way, we increase our customers' competitive strength and make an important contribution to environmental protection with our energy-efficient products and solutions.

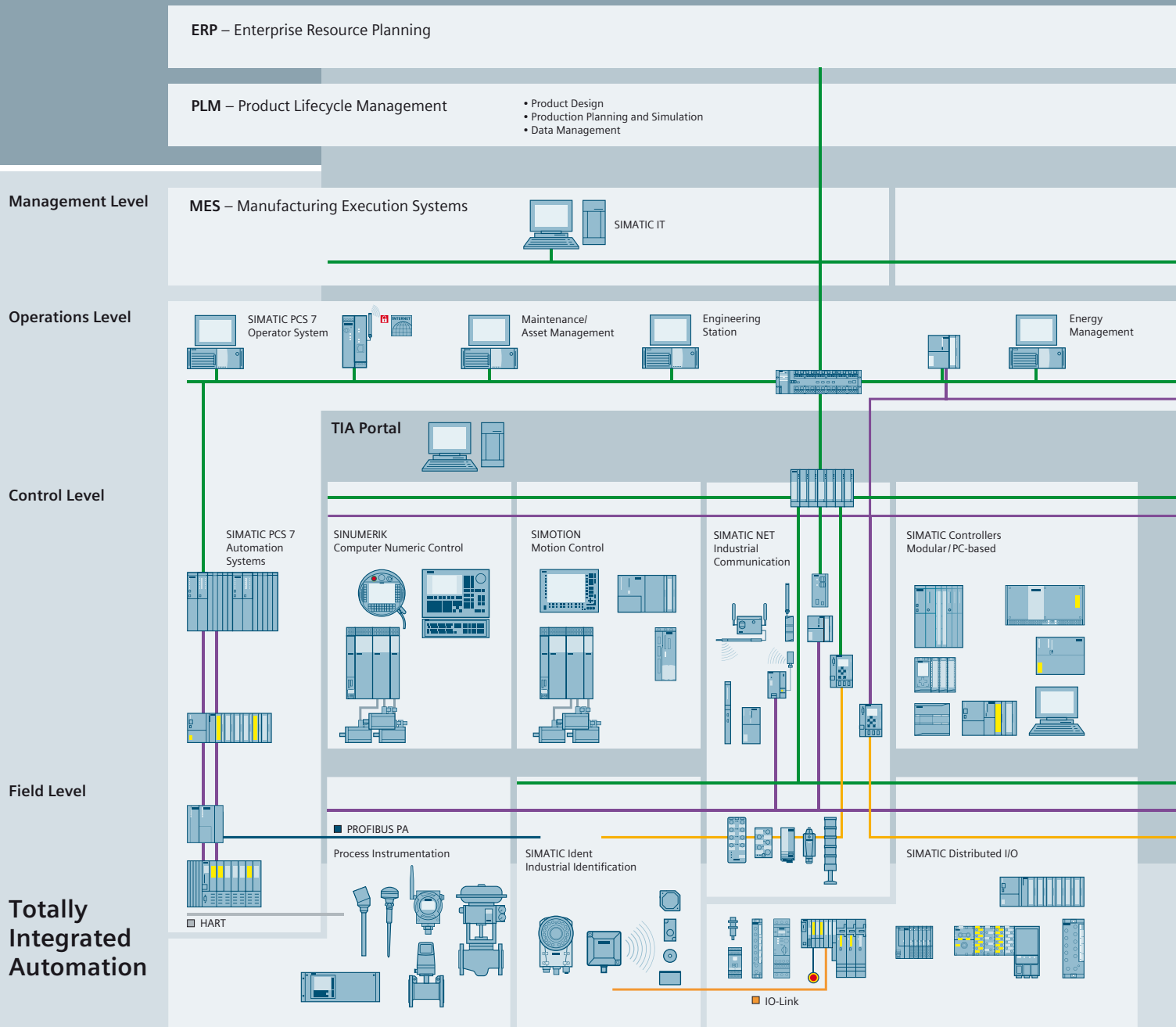

Setting standards in productivity and competitiveness.

Totally Integrated Automation.

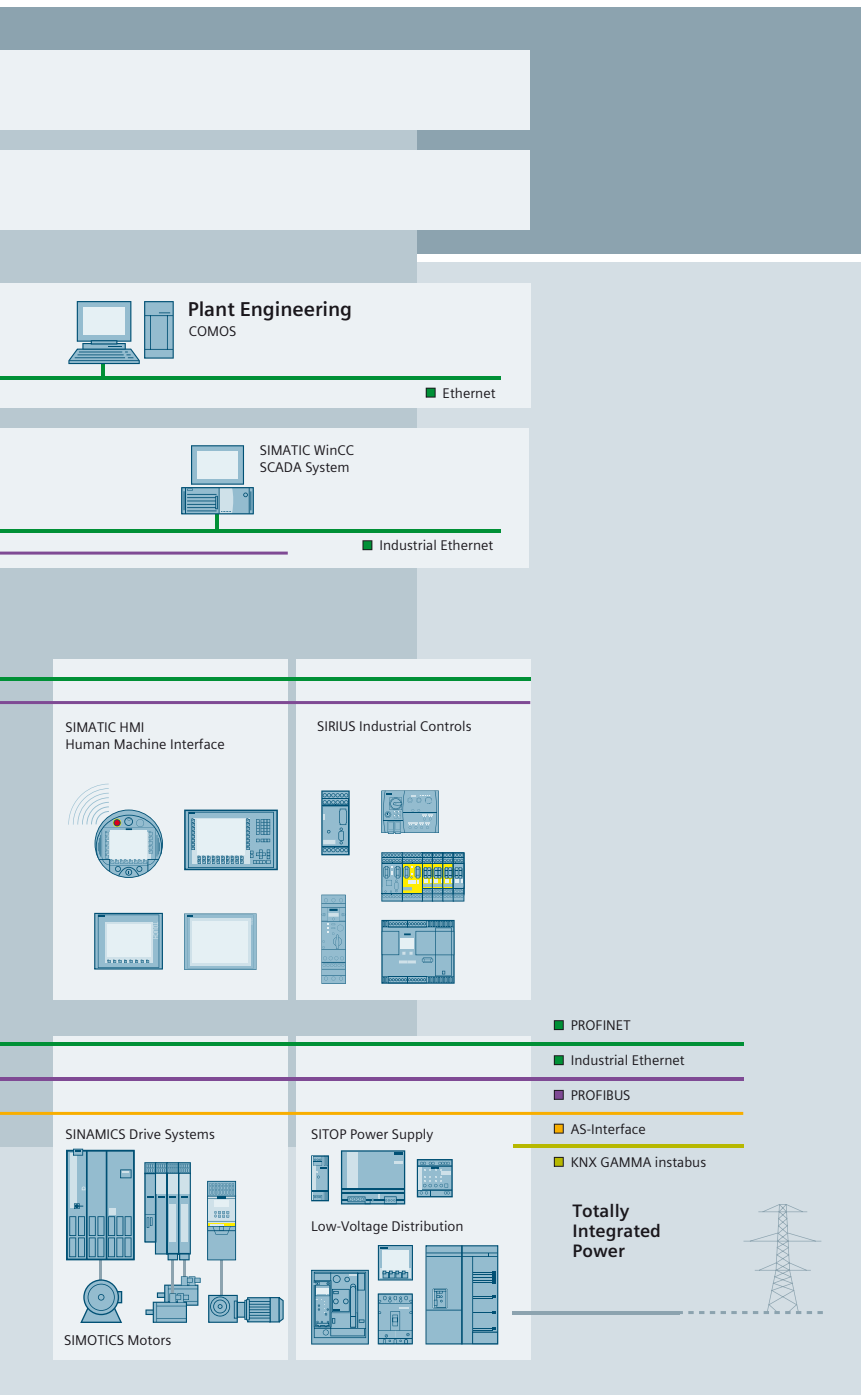

TIA is characterized by its unique continuity.

It provides maximum transparency at all levels with reduced interfacing requirements – covering the field level, production control level, up to the corporate management level. With TIA you also profit throughout the complete life cycle of your plant – starting with the initial planning steps through operation up to modernization, where we offer a high measure of investment security resulting from continuity in the further development of our products and from reducing the number of interfaces to a minimum.

The unique continuity is already a defined characteristic at the development stage of our products and systems.

The result: maximum interoperability – covering the controller, HMI, drives, up to the process control system. This reduces the complexity of the automation solution in your plant. You will experience this, for example, in the engineering phase of the automation solution in the form of reduced time requirements and cost, or during operation using the continuous diagnostics facilities of Totally Integrated Automation for increasing the availability of your plant.

Thanks to Totally Integrated Automation, Siemens provides an integrated basis for the implementation of customized automation solutions – in all industries from inbound to outbound.



**Totally Integrated Power:
Future-proof power supply
from one source.**

Software tools, products, systems and support for integrated electrical power distribution

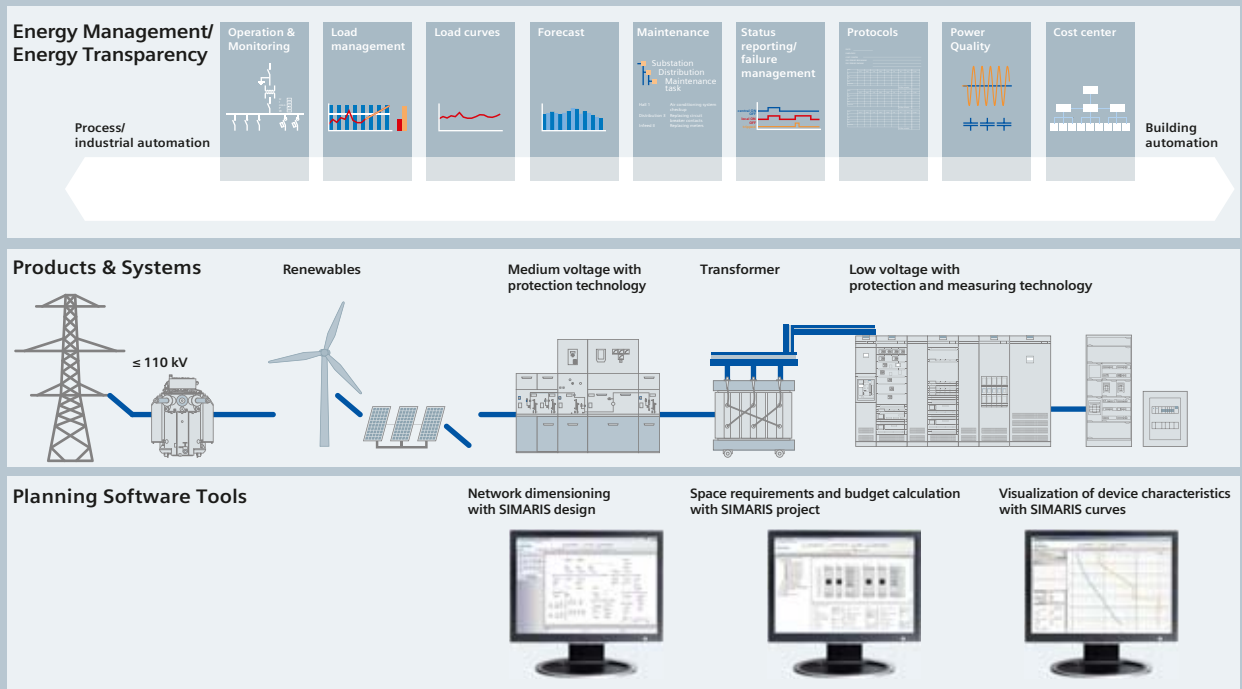

The power supply system acts like a “vital artery”, forming the basis for the reliable and efficient functioning of all electrically operated building installations. Electrical power distribution therefore requires integrated solutions. Our answer: Totally Integrated Power (TIP).

This includes software tools and support for planning and configuration and a complete, optimally aligned product and system portfolio for integrated power distribution from medium-voltage switchgear right to socket outlets.

The power distribution products and systems can be interfaced to building or industrial automation systems (Total Building Solutions or Totally Integrated Automation) via communication-capable circuit breakers and components, allowing the full potential for optimization that an integrated solution offers to be exploited throughout the project cycle – from planning right through to installation and operation.

Get more information:

www.siemens.com/tip
www.siemens.com/simaris
www.siemens.com/specifications

Introduction



- 1/2** [Overview](#)
- 1/2 The ongoing development of a well-proven product
- 1/2 ETO – Always the optimum solution (Engineered to Order)
- 1/3 The leading expert in the field of explosion-proof drives
- 1/3 We will be glad to document the proper functioning and quality of your drive!

1/4 SINAMICS G180

- 1/4 [Overview](#)
- 1/5 [Benefits](#)
- 1/5 [Application](#)
- 1/5 [Design](#)
- 1/5 Platform concept
- 1/5 [Function](#)
- 1/5 Power unit
- 1/5 Control section
- 1/5 Operation and settings
- 1/5 Explosion protection
- 1/5 Safe Torque Off
- 1/6 Communication
- 1/6 Drive behavior
- 1/6 General
- 1/6 [Technical data](#)
- 1/6 Overview of data for SINAMICS G180 compact units, cabinet systems and cabinet units
- 1/6 [More information](#)
- 1/6 Quality management to DIN EN ISO 9001

SINAMICS G180

Introduction

1

Overview

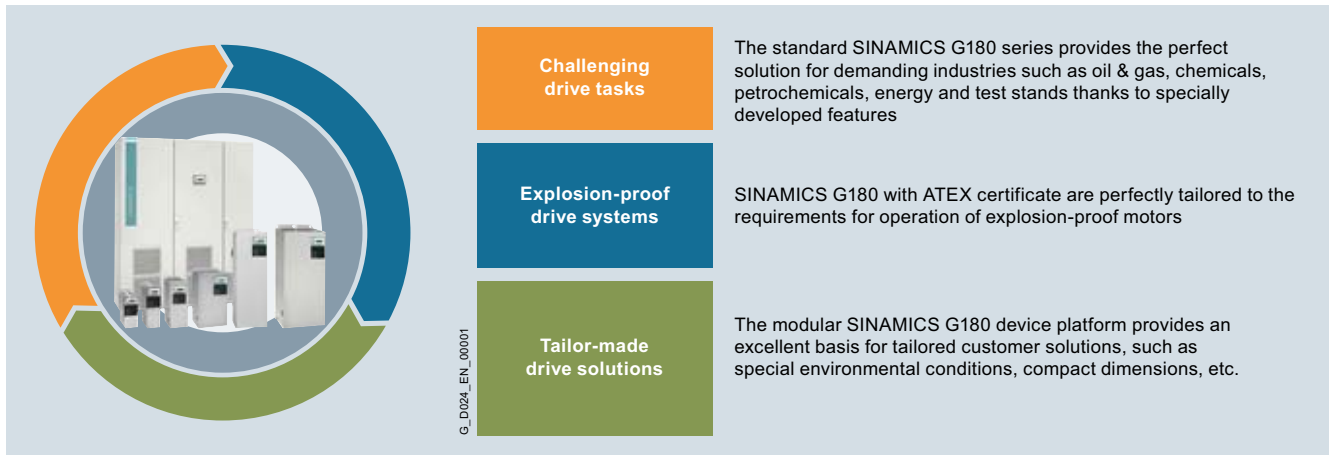

The ongoing development of a well-proven product

SINAMICS G180 is the integration of the LOHER DYNAVERT T Series 7 drive system into the Siemens SINAMICS family of drives.

It leverages the experience that the Siemens Ruhstorf manufacturing location has accumulated and proven in over four decades of successful use in extremely demanding industries, for example, in the chemical and oil & gas industries.

Especially for drive applications in hazardous zones, LOHER Drives & Systems with the DYNAVERT T and its explosion-proof motors is recognized by customers in the specified industries as a reliable and competent partner and enjoys a high degree of esteem and recognition.

The new member of the SINAMICS family – the SINAMICS G180 – completely inherits this outstanding reputation.

For use in hazardous zones, SINAMICS G180 is the perfect drive solution, since a large number of industry-specific features are already integrated as standard in the system.

SINAMICS G180 is capable of fulfilling all requirements, from relatively straightforward applications such as pumps and fans, up to sophisticated drive solutions with outputs ranging from 2.2 to 6600 kW for applications such as centrifuges, presses, extruders or compressors.

ETO – Always the optimum solution (Engineered to Order)

In addition to a broad range of converters for single and group drives with standardized options, we can also supply complete drive systems which are individually customized such as, for example, converter transformer, converter and motor – "Engineered to Order (ETO)".

How does the customer benefit? We can create the required drive system quickly and systematically.

"Engineered to Order" includes all the essential components – motor, converter transformer, accessories for adapting the drive to challenging line supply conditions, degrees of protection up to IP55 or extremely long motor cables, as well as a variety of control and communication concepts – from the planning stage to production and documentation, commissioning and servicing – including and particularly for hazardous zones. Tailor-made solutions for the customer's application are worked out as early as the offer stage. All aspects of the drive are taken into account from the very beginning – from the coupling to the motor, the cabling, the converter, the line system conditions at the installation site and the supervisory control system interface.

ETO also provides documentation which is tailored to your requirements, including a description of the interfaces to the supervisory control system or other external systems.

Taking a structured and efficient approach, we apply our many years of motor manufacturing expertise to the design and adaptation of the SINAMICS G180 because product developments in the motor and converter fields are closely coordinated.

Preassignment of the SINAMICS G180 parameters at the factory speeds up commissioning significantly.

In addition to customized system designs, we offer a range of converter solutions based on standardized accessories packages which are now widely used in a very broad spectrum of industries.

Overview (continued)

The leading expert in the field of explosion-proof drives

LOHER Motors & Drives has been a leading supplier of explosion-proof drives since 1960 and has since built an excellent reputation around the world as a recognized expert in the field.

We are always 100 % reliable when it comes to designing the key explosion-proof features of drive systems. We examine every single element of the entire drive package.

Our frequency converters are specially designed for operation with explosion-proof motors and are certified for EEx n, EEx e and EEx d types of protection according to ATEX.

The motors are protected thermally by temperature sensors which are evaluated directly in the converter. The PTC thermistor input (with ATEX certification) on the converter makes any further accessories such as main contactor or PTC relay completely unnecessary.



We don't leave our customers on their own to deal with the "Ex" problem!

We can answer all your questions such as

- What is the correct converter clock frequency?
- What is the maximum permissible terminal voltage at the motor terminal box?
- How high are the voltage peaks at the motor when long motor cables are used?
- What winding insulation does the motor need?
- Fed-in winding or preformed coil?
- Should the motor be protected by PTCs and/or Pt100s?
- etc.

We will be glad to document the proper functioning and quality of your drive!

We use a state-of-the-art test bay to verify and confirm the proper functioning and quality of each individual converter – and do this gladly in the presence of the customer by way of an acceptance test. In addition to visual inspections and function tests, we can also test and document the output and efficiency of the overall drive and its line supply behavior. Our test stand is equipped with loading devices and measuring instruments for outputs of up to around 6600 kW.

Our quality management is certified in accordance with DIN ISO 9001 and is therefore subject to regular stringent quality audits by independent test institutes.

SINAMICS G180

Introduction

SINAMICS G180

1

Overview



The LOHER DYNAVERT T frequency converter integrated as SINAMICS G180 into the SINAMICS range has been deployed for over forty years for applications where maximum reliability and availability of the drive are of paramount importance.

SINAMICS G180 thus benefits from the many years of expertise acquired by LOHER Motors & Drives in the manufacture of motors and converters to the extent that the frequency converters are always systematically developed to take into account the requirements of the drive system as a whole.

SINAMICS G180 converters can be supplied for standard voltages 400, 500 and 690 V in the output range up to 6.6 MW. They are available as a compact unit, a cabinet system or a cabinet unit, with air or liquid cooling, for operation with synchronous and induction motors.

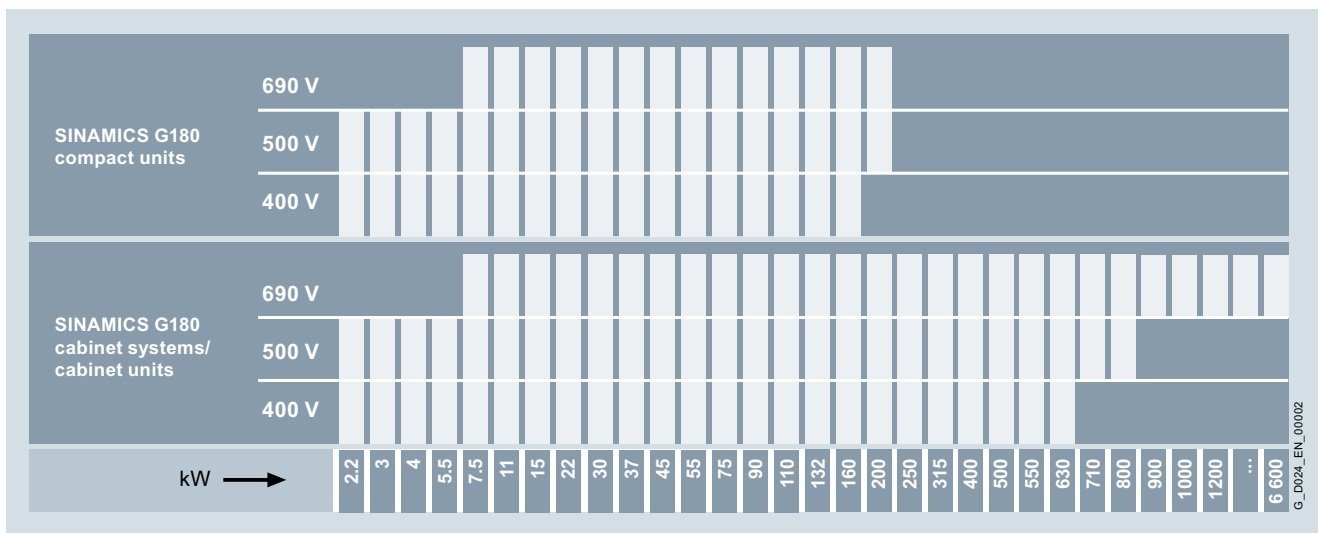

Output ranges of SINAMICS G180 (higher outputs with 400 and 500 V cabinet units available on request)

A wide range of add-on electrical components allow the drive system to be optimized for specific requirements. Configuring is greatly simplified by predefined interfaces and commissioning is speeded up by the preassignment of parameter settings at the factory.

The accuracy of the sensorless vector control makes the converter an ideal partner for many types of drives, such as those used for pumps, fans, centrifuges, presses, extruders or compressors, and an additional actual speed value encoder is therefore superfluous.

Appropriate encoder evaluation units are available for the SINAMICS G180 converters so that they can address applications that require an encoder for plant-specific reasons.

The SINAMICS G180 can be flexibly integrated into any automation concept whether it employs a conventional control or a bus system.

Apart from the standard converter interface (compliant with NAMUR NE37), the following can also be supplied as options to provide communication with the supervisory control system:

- PROFIBUS DP
- Modbus RTU
- Modbus TCP
- CANopen
- Ethernet (PROFIBUS DP with Ethernet-PROFIBUS converter)

Optionally available peripheral boards can be selected to add the following inputs/outputs to the converter:

- Digital and analog inputs and outputs
- 2 PTC thermistor inputs for ATEX-certified motor temperature monitoring for motors in hazardous zones (prewarning/trip)

Benefits

- The converters are exceptionally quiet and compact thanks to state-of-the-art IGBT power semiconductors and an innovative cooling concept.
- The clock frequency is optimized to reduce system losses to a minimum.
- The "random pattern" function significantly reduces motor noise.
- Plant and system availability are increased by being able to quickly and simply replace power components.
- Essential spare parts can be requested at any time for any individual converter by means of the "SparesOnWeb" Internet tool.
- Optimized use of components reduces cabinet dimensions to a minimum.
- Easy integration into automation solutions via analog and digital interfaces. Number of interfaces can also be expanded through installation of an optional peripheral board.
- Data are transmitted over popular bus systems (PROFIBUS DP, CANopen, Modbus RTU or Modbus TCP)
- Fast, easy commissioning and parameterization using interactive menus on an operator panel with illuminated graphic LCD and plain-text display, or PC-supported using the IMS commissioning tool (Inverter Management Software).
- The entire production process is required to meet stringent quality standards and subject to extensive controls, thereby ensuring a high degree of functional reliability during installation, commissioning and operation.

Application

The SINAMICS G180 is especially suited to applications in industries such as the

- chemical industry
- oil and gas industry
- power plant and utilities industries
- plastics industry
- process industry
- primary industry
- test bench systems
- conveyor systems

and for general mechanical engineering applications.

Design

Platform concept

All of the SINAMICS G180 versions are consistently based on an integrated, standardized, common, modular platform concept. Shared hardware and software components, as well as standardized tools for dimensioning, configuring and commissioning tasks ensure a high level of integration between all components.

All devices – from the lowest rating class in compact unit form to the largest version in the form of an air-cooled or liquid-cooled cabinet unit – have the same features with a virtually identical scope of functions.

All frequency converters in the SINAMICS G180 range operate with the Control Board. All Control Boards utilize the same firmware and all are operated via the Inverter Management Software IMS. Both the IMS and the firmware can be upgraded and downgraded as required to facilitate communication.

Function

Power unit

- Complies with EMC guidelines defined in EN 61800-3 thanks to line filter which is integrated as standard (with grounded supply system)
 - Category C2 for compact units in TN/TT system of the first environment (residential area), category C1 available as an option
 - Category C3 for cabinet units (TN/TT system) of the second environment (industrial area)
 - Category C4 for compact and cabinet units in IT system of the second environment (industrial area)
- SINAMICS G180 converters cause minor line harmonics: Thanks to line reactors integrated in cabinet units and DC reactors integrated in compact units
- Output filter to permit the use of long motor cables for motors with standard insulation
- Insulation monitoring for IT systems integrated in 500/690 V units and ground fault monitoring for TN and TT systems integrated in 400 V units
- Wide range of input voltages
- Lower additional motor noise emissions of typically 3 dB(A) as well as minor losses in converter and motor thanks to optimized pulse pattern and converter clock frequency
- Units can be protected by standard fuses (gL characteristic)
- Standardized user interface on units rated from 2.2 to 6600 kW

Control section

- High level of protection for personnel and plant is provided by protective separation of the safety extra-low voltage in accordance with IEC/EN 61800-5-1 at the analog and digital control inputs and outputs of the power unit.

Operation and settings

- Straightforward to operate and set by means of a menu-assisted, 4-line plaintext display with membrane keyboard on the converter unit or remotely from the control room via an RS485 link at a distance of up to 1000 m
- Extensive range of functions using a Windows-based PC operating program

Explosion protection

- ATEX-certified tripping concept in accordance with Directive 94/9 EC for the safe operation of motors in hazardous zones 1 and 2, which means that no main contactor is required

Safe Torque Off

Available with options **G04, G05, G08**

- Shutdown mechanism to prevent unexpected starting. Category 0 stop function in accordance with EN 60204-1 (stop by disconnection of power supply to the machine).
- Functional safety in accordance with:
 - SIL 2 as per EN 61508
 - Category 3 to EN ISO 13849-1
 - Performance Level (PL) d to EN ISO 13849-1
- Functional safety in accordance with IEC 61508: SIL 3 is possible in conjunction with options **S01+Y11** or **S02+Y11**.

SINAMICS G180

Introduction

SINAMICS G180

1

Function (continued)

Communication

- Communication via conventional terminal strip with freely programmable digital and analog inputs/outputs with
 - parameterizable limit value signals
 - parameterizable timers
 - parameterizable attenuators
 - parameterizable converter behavior when inputs/outputs respond
 - parameterizable logic elements
- Communication and parameterization by means of
 - PC using IMS (Inverter Management Software) via USB interface
 - External operator panel via RS485 link
 - Bus systems such as Ethernet (PROFIBUS with Ethernet-to-PROFIBUS converter board), PROFIBUS DP, CANopen, Modbus RTU or Modbus TCP

Drive behavior

- Closed-loop control of synchronous and induction motors
- Two control modes for induction motors:
 - Space vector control for standard applications (without feedback)
 - Field-oriented closed-loop control for dynamic requirements
- Optimum braking without any supplementary equipment by means of oversaturation control system. With approximately 10 % braking torque at high speed range and up to 50 % at low to medium speed range.

General

- Automatic slip compensation
- Stall protection provided by current limitation control
- Flying restart function for connection to rotating motor
- Automatic adjustment of the overload times
- Parameterizable DC braking for precise deceleration down to zero speed
- Torque control
- Automatic restart (Auto Restart)
- Voltage and current control systems (AC as well as DC with variable frequency)
- Mains supply backup is possible
- Integrated process controller for basic, higher-level closed-loop control tasks
- Optionally available integrated braking chopper for increased braking torque
- Operation of groups of units with interconnected DC links is possible

Technical data

Overview of data for SINAMICS G180 compact units, cabinet systems and cabinet units

Type	Converter
Output range	2.2 to 6600 kW (3 to 8851 hp)
Input voltage	230 to 690 V AC (standard), 50/60 Hz
Pulse number	6-/12-/18-/24-pulse
Type of cooling	Air-cooled and liquid-cooled
Machine type	Induction motor, synchronous motor

More information

Quality management to DIN EN ISO 9001

SINAMICS G180 converters conform to the most exacting quality requirements. Comprehensive quality assurance measures in all development and production processes ensure a consistently high level of quality.

Of course, our quality management system is certified by an independent authority in accordance with DIN EN ISO 9001.

SINAMICS G180 compact units and SINAMICS G180 cabinet systems

2



2/2	SINAMICS G180 compact units
2/2	Overview
2/2	Design
2/2	Technical data
2/2	Standards for compact units
2/3	General technical data
2/4	400 V, 6-pulse
2/8	500 V, 6-pulse
2/12	690 V, 6-pulse
2/15	Selection and ordering data
2/15	400 V, 6-pulse
2/15	500 V, 6-pulse
2/16	690 V, 6-pulse
2/17	Article number code
2/17	Number code for converter type
2/18	Options
2/18	400 V TN/TT system
2/18	500 V IT system
2/18	690 V TN/TT system
2/18	690 V IT system
2/21	Dimensional drawings
2/21	Frame size K1
2/22	Frame size K2
2/23	Frame size K3
2/24	Frame size K4
2/25	Frame size K5
2/26	Frame size K51
2/27	Frame size K6
2/28	SINAMICS G180 cabinet systems
2/28	Overview
2/28	Design
2/29	Selection and ordering data
2/29	400 V, 6-pulse
2/29	500 V, 6-pulse
2/30	690 V, 6-pulse
2/31	Article number code
2/31	Number code for converter type
2/32	Options
2/32	400 V TN/TT system
2/32	500 V IT system
2/39	690 V TN/TT system
2/39	690 V IT system
2/46	Dimensional drawing
2/46	Standard cabinet size for cabinet systems (option H81)

SINAMICS G180

SINAMICS G180 compact units and SINAMICS G180 cabinet systems

SINAMICS G180 compact units

Overview

The compact version of the SINAMICS G180 is a converter that can be combined very flexibly with the associated system components and integrated into customer-specific control cabinets or directly into machines.

Global use

SINAMICS G180 converter compact units are manufactured in compliance with relevant international standards and regulations, and are therefore suitable for global use (see technical data).

SINAMICS G180 converter compact units are available for the following voltages and power ratings:

Overview of voltages and power ratings for SINAMICS G180 compact units

Rated line voltage	Power
400 V 3 AC	2.2 ... 160 kW
500 V 3 AC	2.2 ... 200 kW
690 V 3 AC	7.5 ... 200 kW

Design

- Rugged, compact aluminum enclosure
- IP20 degree of protection, optionally with IP21 protective top cover
- Convenient terminal compartment for EMC-compliant cable connections to NAMUR NE 37 in the device
- Complete touch protection in accordance with Employers' Liability Association regulations (BGV A3)
- DC reactor fitted as standard to reduce harmonics, THD I 5th < 40 %
- dv/dt filter fitted as standard to reduce voltage peaks in the motor



SINAMICS G180 compact unit

Technical data

The most important directives and standards are listed below. These are used as basis for the SINAMICS G180 compact units and they must be carefully observed to achieve an EMC-compliant configuration that is safe both functionally and in operation.

Standards for compact units

European directives

2006/95/EC	Low-voltage directive: Legal guidelines of the EU member states concerning electrical equipment for use within specified voltage limits
2004/108/EC	EMC Directive: Legal guidelines of the EU member states for electromagnetic compatibility

International and European standards

EN 954-1	Safety of machinery – Safety-related parts of control systems; Part 1: General design principles
EN ISO 13849-1	Safety of machinery – Safety-related parts of control systems; Part 1: General design principles (EN ISO 13849-1:2006) (replaced EN 954-1)
EN 60146-1-1	Semiconductor converters – General requirements and line-commutated converters Part 1-1: Specification of basic requirements
EN 60204-1	Electrical equipment of machines, Part 1: General definitions
EN 60529	Degrees of protection provided by enclosures (IP code)
EN 61140	Protection against electric shock – Common aspects for installation and equipment
EN 61508-1	Functional safety of electrical/electronic/programmable electronic safety-related systems, Part 1: General requirements
EN 61800-2	Adjustable speed electrical power drive systems, Part 2: General requirements – Rating specifications for low-voltage adjustable frequency AC power drive systems
EN 61800-3	Adjustable speed electrical power drive systems, Part 3: EMC requirements and specific test methods
EN 61800-5-1	Adjustable-speed electrical power drive systems, Part 5-1: Safety requirements – Electrical, thermal and energy requirements
EN 61800-5-2	Adjustable-speed electrical power drive systems, Part 5-2: Safety requirements – Functional safety (IEC 61800-5-2:2007)

North American standards

UL508C ¹⁾	Power conversion equipment
----------------------	----------------------------

Approvals

TÜV NRTL US ¹⁾	Nationally Recognized Testing Laboratory
---------------------------	--

¹⁾ On request

Technical data (continued)

General technical data

Electrical data			
	Line voltages	Type of supply system	Power ranges
	230 ... 400 ... 500 V 3 AC, -15/+10 %	TN/TT system	2.2 ... 160 kW (at 400 V)
	230 ... 500 V 3 AC, -15/+10 %	IT system	2.2 ... 200 kW (at 500 V)
	230 ... 690 V 3 AC, -15/+10 %	TN/TT or IT system	7.5 ... 200 kW (at 690 V)
Line frequency	47 ... 63 Hz		
Output frequency	0 ... 250 Hz		
Voltage rise in motor	Typ. 500 ... 1000 V/μs, but < 1500 V/μs		
Typical line harmonics (I) in % of fundamental mode for the 5/7/11/13/17/19/23/25 harmonics max.	38/18/8/7/5/4/3/2		
Typical line harmonics (I) in % of fundamental mode for the 5/7/11/13/17/19/23/25 harmonics max. with LHF filter	1.4/3.6/2.4/1.7/1.0/0.6/0.8/0.4		
Pulse number	6		
Overvoltage category	III to EN 61800-5-1		
Short Circuit Current Rating (SCCR) according to UL508C (up to 600 V), in conjunction with the specified fuses or circuit breakers	60 kA		
Control method	<ul style="list-style-type: none"> For motors: Field-oriented control (FOC) with sensor and approval for explosion-proof motors as well as vector control (SVC) with/without sensor (speed, process <i>speed</i> (<i>n</i>), torque, hoist¹), line synchronization¹) Motor-independent control of current or voltage (current, process <i>current</i> (<i>I</i>), voltage, process <i>voltage</i> (<i>U</i>)) 		
Fixed speeds	3 fixed speeds + 1 minimum speed, parameterizable		
Skipped speed ranges	2, parameterizable		
Setpoint resolution	13 bits digital with <i>n/f</i> setpoint, 12 bits digital with <i>U/I</i> torque setpoint, 9 bits + sign analog		
Braking operation	The oversaturation control system makes it possible to generate a braking torque of up to 50 % at low to mid-range speeds, and of up to 10 % at high speeds. If a higher braking torque is required, an optionally available braking module with appropriate braking resistor must be installed.		
Mechanical data			
Degree of protection	IP20, optionally IP21 provided by protective top cover (aluminum, unpainted)		
Protection class	I acc. to EN 61800-5-1		
Touch protection	EN 50274 / BGV A3		
Type of cooling	Forced air cooling AF to EN 60146		
Paint finish	RAL 9023 (R-Pearl Dark Grey)		
Cable entry	From below		
Ambient conditions ²⁾	Storage ³⁾	Transport ³⁾	Operation
Ambient temperature	-25 ... +70 °C	-25 ... +70 °C down to -40 °C for 24h	Air: 0 ... 40 °C/
	Class 1K4 acc. to EN 60721-3-1	Class 2K3 acc. to EN 60721-3-2	-
Relative humidity (condensation not permissible)	5 ... 95 % Class 1K3 acc. to EN 60721-3-1	5 ... 95 % Class 2K3 acc. to EN 60721-3-2	5 ... 95 % Class 3K3 acc. to EN 60721-3-3
Environmental class/harmful chemical substances	Class 1C2 acc. to EN 60721-3-1	Class 2C2 acc. to EN 60721-3-2	Class 3C2 acc. to EN 60721-3-3
Organic/biological influences	Class 1B1 acc. to EN 60721-3-1	Class 2B1 acc. to EN 60721-3-2	Class 3B1 acc. to EN 60721-3-3
Pollution degree	2 acc. to EN 61800-5-1		
Installation altitude	Up to 1000 m above sea level without derating, > 1000 m see derating table (in chapter Configuring instructions)		
Mechanical stability ²⁾	Storage ³⁾	Transport ³⁾	Operation
Vibratory load	1.5 mm at 5 ... 9 Hz	3.1 mm at 5 ... 9 Hz	0.075 mm at 10 ... 58 Hz
• Deflection	5 m/s ² at >9 ... 200 Hz	10 m/s ² at > 9 ... 200 Hz	10 m/s ² at > 58 ... 200 Hz
• Acceleration	Class 1M2 acc. to EN 60721-3-1	Class 2M2 acc. to EN 60721-3-2	-
Shock load	40 m/s ² at 22 ms	100 m/s ² at 11 ms	100 m/s ² at 11 ms
• Acceleration	Class 1M2 acc. to EN 60721-3-1	Class 2M2 acc. to EN 60721-3-2	Class 3M4 acc. to EN 60721-3-3
Compliance with standards			
CE Label	Acc. to EMC Directive No. 2004/108/EC and Low-Voltage Directive No. 2006/95/EC		
Radio interference suppression	Complies with EMC guidelines defined in EN 61800-3 thanks to line filter which is integrated as standard (with grounded supply system): <ul style="list-style-type: none"> Category C2 for compact units in TN/TT system of the first environment (residential area), category C1 available as an option Category C4 for compact units in IT system of the second environment (industrial area) 		
Approvals	TÜV NRTL US ²⁾		

Deviations from the specified classes are underlined.

1) On request

3) In transport packaging

2) Higher standards on request

SINAMICS G180

SINAMICS G180 compact units and SINAMICS G180 cabinet systems

SINAMICS G180 compact units

Technical data (continued)

400 V, 6-pulse

Line voltage, supply system type	230 ... 500 V 3 AC, TT/TN					
SINAMICS G180 compact units	6SE0100-1AC15-5■A7	6SE0100-1AC17-0■A7	6SE0100-1AC21-0■A7	6SE0100-1AC21-3■A7	6SE0100-1AC21-8■A7	6SE0100-1AC21-8■A7
Converter type	2T2A-07400-002	2T2A-07400-003	2T2A-07400-004	2T2A-07400-005	2T2A-07400-007	2T2A-07400-007
Electrical data at motor end						
Type rating ¹⁾						
• at 50 Hz 400 V	kW	2.2	3	4	5.5	7.5
• at 60 Hz 460 V	hp	3	5	6	9	12
Output voltage ²⁾	V	0 ... 0.98 × V _{line}	0 ... 0.98 × V _{line}	0 ... 0.98 × V _{line}	0 ... 0.98 × V _{line}	0 ... 0.98 × V _{line}
Output current						
• Continuous current	A	5.5	7	9.5	13	18
• Short-time current (60 s every 10 minutes) max.	A	6.5	8	11	15	20
Overload capability (60 s every 10 minutes) max.	%	18	14	16	15	11
Output power	kVA	3.8	4.8	6.6	9	12.5
Output frequency, max.	Hz	250	250	250	250	250
Rated clock cycle	kHz	4.5	4.5	4.5	4.5	4.5
adjustable from	kHz	3 ... 7.5	3 ... 7.5	3 ... 7.5	3 ... 7.5	3 ... 7.5
Power loss ³⁾	kW	0.13	0.16	0.2	0.26	0.33
Rated efficiency	%	95.2	95.8	95.9	96	96.2
Electrical data at line end						
Connected load	kVA	3.7	4.5	6.2	8.5	12
Rated input voltage	V	400	400	400	400	400
Input current						
• Continuous line current	A	5.3	6.5	8.9	12.2	17.3
• Short-time line current (60 s) max.	A	6.3	7.4	10	14	19
Line fuse (provided by customer)	gL (A)	6 ... 16	10 ... 16	10 ... 16	16	20 ... 32
λ _{line}		0.927	0.94	0.918	0.937	0.918
Cos φ _{line}		1	1	1	1	1
Radio interference suppression acc. to EN 61800-3		C2 (class A filter)	C2 (class A filter)	C2 (class A filter)	C2 (class A filter)	C2 (class A filter)
Mechanical data						
Coolant requirements	m ³ /h	45	45	90	90	90
Sound pressure level L _{pA} (1 m) at 50/60 Hz	dB	60	60	60	60	60
Max. cable length between converter and motor with standard insulation						
• on systems ≤ 400 V (shielded)	m	200/350 ⁴⁾	200/350 ⁴⁾	200/350 ⁴⁾	200/350 ⁴⁾	200/350 ⁴⁾
• on systems > 400 V (shielded)	m	150/300 ⁴⁾	150/300 ⁴⁾	150/300 ⁴⁾	150/300 ⁴⁾	150/300 ⁴⁾
Line/load connection						
L1, L2, L3/U2, V2, W2						
For connection cross-sections, see "Cable cross-sections and connections" in section "Configuring instructions"						
Dimensions						
• Width	mm	165	165	165	165	165
• Height (without mounting brackets)	mm	410	410	410	410	510
• Depth	mm	320	320	320	320	320
Weight, approx.	kg	11.5	11.5	11.5	11.5	16.5
Approvals, according to		NRTL ⁵⁾	NRTL ⁵⁾	NRTL ⁵⁾	NRTL ⁵⁾	NRTL ⁵⁾
Frame size		K1	K1	K1	K1	K2

¹⁾ Rated power of a typical 2- to 6-pole standard motor.

²⁾ Typical output voltage dependent on filter and unit type.

³⁾ Maximum power loss with continuous current.

⁴⁾ Value is applicable with option L10 (strengthened dv/dt filter; strengthened filter is integrated in unit).

⁵⁾ On request

SINAMICS G180

SINAMICS G180 compact units and SINAMICS G180 cabinet systems

SINAMICS G180 compact units

Technical data (continued)

400 V, 6-pulse (continued)

Line voltage, supply system type		230 ... 500 V 3 AC, TT/TN				
SINAMICS G180 compact units		6SE0100-1AC22-5■A7	6SE0100-1AC23-7■A7	6SE0100-1AC24-8■A7	6SE0100-1AC25-8■A7	6SE0100-1AC27-8■A7
Converter type		2T2A-07400-011	2T2A-07400-015	2T2A-07400-022	2T2A-07400-030	2T2A-07400-037
Electrical data at motor end						
Type rating ¹⁾						
• at 50 Hz 400 V	kW	11	15	22	30	37
• at 60 Hz 460 V	hp	17	23	34	46	57
Output voltage ²⁾						
	V	0 ... 0.98 × V _{line}	0 ... 0.98 × V _{line}	0 ... 0.98 × V _{line}	0 ... 0.98 × V _{line}	0 ... 0.98 × V _{line}
Output current						
• Continuous current	A	24.5	37	48	58	78
• Short-time current (60 s every 10 minutes) max.	A	27	44	54	63	88
Overload capability (60 s every 10 minutes) max.						
	%	10	19	13	9	13
Output power						
	kVA	17	25.6	33.3	40.2	54
Output frequency, max.						
	Hz	250	250	250	250	250
Rated clock cycle						
	kHz	4.5	4.5	4.5	4.5	3
adjustable from	kHz	3 ... 7.5	3 ... 7.5	3 ... 7.5	3 ... 7.5	2 ... 5
Power loss ³⁾						
	kW	0.47	0.6	0.84	1.1	1.35
Rated efficiency						
	%	96.3	96.5	96.6	96.7	96.7
Electrical data at line end						
Connected load						
	kVA	15.7	24.3	31.8	39.1	52.2
Rated input voltage						
	V	400	400	400	400	400
Input current						
• Continuous line current	A	22.7	35.1	45.9	56.5	75.3
• Short-time line current (60 s) max.	A	25	42	52	61	85
Line fuse (provided by customer)						
	gL (A)	25 ... 32	40 ... 80	50 ... 80	63 ... 80	80 ... 100
λ_{line}						
		0.932	0.932	0.932	0.924	0.932
Cos ϕ_{line}						
		1	1	1	1	1
Radio interference suppression acc. to EN 61800-3						
		C2 (class A filter)	C2 (class A filter)	C2 (class A filter)	C2 (class A filter)	C2 (class A filter)
Mechanical data						
Coolant requirements						
	m ³ /h	130	280	280	280	750
Sound pressure level L _{pA} (1 m) at 50/60 Hz						
	dB	60	60	60	60	62
Max. cable length between converter and motor with standard insulation						
• on systems ≤ 400 V (shielded)	m	200/350 ⁴⁾	200/350 ⁴⁾	200/350 ⁴⁾	200/350 ⁴⁾	200/350 ⁴⁾
• on systems > 400 V (shielded)	m	150/300 ⁴⁾	150/300 ⁴⁾	150/300 ⁴⁾	150/300 ⁴⁾	150/300 ⁴⁾
Line/load connection						
L1, L2, L3/U2, V2, W2						
For connection cross-sections, see "Cable cross-sections and connections" in section "Configuring instructions"						
Dimensions						
• Width	mm	165	225	225	225	350
• Height (without mounting brackets)	mm	510	610	610	610	710
• Depth	mm	320	320	320	320	320
Weight, approx.						
	kg	16.5	30	31	31	51
Approvals, according to						
		NRTL ⁵⁾	NRTL ⁵⁾	NRTL ⁵⁾	NRTL ⁵⁾	NRTL ⁵⁾
Frame size						
		K2	K3	K3	K3	K4

¹⁾ Rated power of a typical 2- to 6-pole standard motor.

²⁾ Typical output voltage dependent on filter and unit type.

³⁾ Maximum power loss with continuous current.

⁴⁾ Value is applicable with option L10 (strengthened dv/dt filter; strengthened filter is integrated in unit).

⁵⁾ On request

SINAMICS G180

SINAMICS G180 compact units and SINAMICS G180 cabinet systems

SINAMICS G180 compact units

Technical data (continued)

400 V, 6-pulse (continued)

Line voltage, supply system type		230 ... 500 V 3 AC, TT/TN				
SINAMICS G180 compact units		6SE0100-1AC28-8■A7	6SE0100-1AC31-1■A7	6SE0100-1AC31-5■A7	6SE0100-1AC31-8■A7	6SE0100-1AC32-1■A7
Converter type		2T2A-07400-045	2T2A-07400-055	2T2A-07400-075	2T2A-07400-090	2T2A-07400-110
Electrical data at motor end						
Type rating ¹⁾						
• at 50 Hz 400 V	kW	45	55	75	90	110
• at 60 Hz 460 V	hp	69	85	116	139	170
Output voltage ²⁾						
	V	0 ... 0.98 × V _{line}	0 ... 0.98 × V _{line}	0 ... 0.98 × V _{line}	0 ... 0.98 × V _{line}	0 ... 0.98 × V _{line}
Output current						
• Continuous current	A	88	110	145	175	205
• Short-time current (60 s every 10 minutes) max.	A	110	126	165	204	240
Overload capability (60 s every 10 minutes) max.						
	%	25	15	14	17	17
Output power						
	kVA	61	76.2	100	121	142
Output frequency, max.						
	Hz	250	250	250	250	250
Rated clock cycle						
	kHz	3	3	3	3	3
adjustable from	kHz	2 ... 5	2 ... 5	2 ... 5	2 ... 5	2 ... 5
Power loss ³⁾						
	kW	1.59	1.86	2.37	2.83	3.33
Rated efficiency						
	%	96.8	96.9	97.1	97.1	97.2
Electrical data at line end						
Connected load						
	kVA	57.3	74.8	97.7	119	134
Rated input voltage						
	V	400	400	400	400	400
Input current						
• Continuous line current	A	82.7	108	141	172	194
• Short-time line current (60 s) max.	A	103	124	160	200	227
Line fuse (provided by customer)						
	gL (A)	100	125	160	200	200 ... 250
λ_{line}						
		0.924	0.929	0.929	0.924	0.924
Cos ϕ_{line}						
		1	1	1	1	1
Radio interference suppression acc. to EN 61800-3						
		C2 (class A filter)	C2 (class A filter)	C2 (class A filter)	C2 (class A filter)	C2 (class A filter)
Mechanical data						
Coolant requirements						
	m ³ /h	750	750	1050	1050	1050
Sound pressure level L _{pA} (1 m) at 50/60 Hz						
	dB	62	62	64	64	64
Max. cable length between converter and motor with standard insulation						
• on systems ≤ 400 V (shielded)	m	200/350 ⁴⁾	200/350 ⁴⁾	200/350 ⁴⁾	200/350 ⁴⁾	200/350 ⁴⁾
• on systems > 400 V (shielded)	m	150/300 ⁴⁾	150/300 ⁴⁾	150/300 ⁴⁾	150/300 ⁴⁾	150/300 ⁴⁾
Line/load connection						
L1, L2, L3/U2, V2, W2						
For connection cross-sections, see "Cable cross-sections and connections" in section "Configuring instructions"						
Dimensions						
• Width	mm	350	350	350	350	350
• Height (without mounting brackets)	mm	710	710	1060	1060	1060
• Depth	mm	320	320	320	320	320
Weight, approx.						
	kg	53	55	90	94	96
Approvals, according to						
		NRTL ⁵⁾	NRTL ⁵⁾	NRTL ⁵⁾	NRTL ⁵⁾	NRTL ⁵⁾
Frame size						
		K4	K4	K5	K5	K5

¹⁾ Rated power of a typical 2- to 6-pole standard motor.

²⁾ Typical output voltage dependent on filter and unit type.

³⁾ Maximum power loss with continuous current.

⁴⁾ Value is applicable with option L10 (strengthened dv/dt filter; strengthened filter is integrated in unit).

⁵⁾ On request

Technical data (continued)

400 V, 6-pulse (continued)

Line voltage, supply system type	230 ... 500 V 3 AC, TT/TN		
SINAMICS G180 compact units	6SE0100-1AC32-5■A7 6SE0100-1AC33-0■A7		
<i>Converter type</i>	2T2A-07400-132 2T2A-07400-160		
Electrical data at motor end			
Type rating¹⁾			
• at 50 Hz 400 V	kW	132	160
• at 60 Hz 460 V	hp	204	247
Output voltage²⁾	V	0 ... 0.98 × V _{line}	0 ... 0.98 × V _{line}
Output current			
• Continuous current	A	245	295
• Short-time current (60 s every 10 minutes) max.	A	300	360
Overload capability (60 s every 10 minutes) max.	%	22	22
Output power	kVA	170	204
Output frequency, max.	Hz	250	250
Rated clock cycle	kHz	3	3
adjustable from	kHz	2 ... 5	2 ... 5
Power loss³⁾	kW	3.84	4.65
Rated efficiency	%	97.3	97.3
Electrical data at line end			
Connected load	kVA	161	197
Rated input voltage	V	400	400
Input current			
• Continuous line current	A	232	284
• Short-time line current (60 s) max.	A	284	347
Line fuse (provided by customer)	gL (A)	250 ... 315	315 ... 400
λ_{line}		0.924	0.924
$\cos \phi_{line}$		1	1
Radio interference suppression acc. to EN 61800-3		C2 (class A filter)	C2 (class A filter)
Mechanical data			
Coolant requirements	m ³ /h	1600	1600
Sound pressure level L_{pA} (1 m) at 50/60 Hz	dB	66	66
Max. cable length between converter and motor with standard insulation			
• on systems ≤ 400 V (shielded)	m	200/350 ⁴⁾	200/350 ⁴⁾
• on systems > 400 V (shielded)	m	150/300 ⁴⁾	150/300 ⁴⁾
Line/load connection			
L1, L2, L3/U2, V2, W2 For connection cross-sections, see "Cable cross-sections and connections" in section "Configuring instructions"			
Dimensions			
• Width	mm	500	500
• Height (without mounting brackets)	mm	1060	1060
• Depth	mm	320	320
Weight, approx.	kg	160	170
Approvals, according to		NRTL ⁵⁾	NRTL ⁵⁾
Frame size		K6	K6

1) Rated power of a typical 2- to 6-pole standard motor.

2) Typical output voltage dependent on filter and unit type.

3) Maximum power loss with continuous current.

4) Value is applicable with option L10 (strengthened dv/dt filter; strengthened filter is integrated in unit).

5) On request

SINAMICS G180

SINAMICS G180 compact units and SINAMICS G180 cabinet systems

SINAMICS G180 compact units

Technical data (continued)

500 V, 6-pulse

Line voltage, supply system type		230 ... 500 V 3 AC, IT				
SINAMICS G180 compact units		6SE0100-1AD14-5■A7	6SE0100-1AD15-5■A7	6SE0100-1AD17-0■A7	6SE0100-1AD21-0■A7	6SE0100-1AD21-3■A7
Converter type		2T2A-07500-002	2T2A-07500-003	2T2A-07500-004	2T2A-07500-005	2T2A-07500-007
Electrical data at motor end						
Type rating ¹⁾						
• at 50 Hz 500 V	kW	2.2	3	4	5.5	7.5
• at 60 Hz 460 V	hp	3	4	5	7	9
Output voltage ²⁾	V	0 ... 0.98 × V _{line}				
Output current						
• Continuous current	A	4.5	5.5	7	9.5	13
• Short-time current (60 s every 10 minutes) max.	A	5	6.5	8	11	15
Overload capability (60 s every 10 minutes) max.	%	11	18	14	16	15
Output power	kVA	3.9	4.8	6.1	8.2	11.3
Output frequency, max.	Hz	250	250	250	250	250
Rated clock cycle	kHz	4.5	4.5	4.5	4.5	4.5
adjustable from	kHz	3 ... 7.5	3 ... 7.5	3 ... 7.5	3 ... 7.5	3 ... 7.5
Power loss ³⁾	kW	0.12	0.16	0.2	0.26	0.34
Rated efficiency	%	95.6	95.7	95.9	96.0	96.1
Electrical data at line end						
Connected load	kVA	3.7	4.6	6.4	8.6	12.1
Rated input voltage	V	500	500	500	500	500
Input current						
• Continuous line current	A	4.4	5.2	6.5	9.3	12.5
• Short-time line current (60 s) max.	A	4.9	6.1	7.4	11	14
Line fuse (provided by customer)	gL (A)	4 ... 16	6 ... 16	10 ... 16	10 ... 16	16
λ _{line}		0.902	0.912	0.932	0.908	0.927
Cos φ _{line}		1	1	1	1	1
Radio interference suppression acc. to EN 61800-3		C4	C4	C4	C4	C4
Mechanical data						
Coolant requirements	m ³ /h	45	45	45	90	90
Sound pressure level L _{pA} (1 m) at 50/60 Hz	dB	60	60	60	60	60
Max. cable length between converter and motor with standard insulation						
• (shielded)	m	300 ⁴⁾	300 ⁴⁾	300 ⁴⁾	300 ⁴⁾	300 ⁴⁾
Line/load connection						
L1, L2, L3/U2, V2, W2						
For connection cross-sections, see "Cable cross-sections and connections" in section "Configuring instructions"						
Dimensions						
• Width	mm	165	165	165	165	165
• Height (without mounting brackets)	mm	410	410	410	410	410
• Depth	mm	320	320	320	320	320
Weight, approx.	kg	11.5	11.5	11.5	11.5	11.5
Approvals, according to		NRTL ⁵⁾	NRTL ⁵⁾	NRTL ⁵⁾	NRTL ⁵⁾	NRTL ⁵⁾
Frame size		K1	K1	K1	K1	K1

¹⁾ Rated power of a typical 2- to 6-pole standard motor.

²⁾ Typical output voltage dependent on filter and unit type.

³⁾ Maximum power loss with continuous current.

⁴⁾ Option L10 included (strengthened dv/dt filter; strengthened filter is integrated in unit).

⁵⁾ On request

SINAMICS G180

SINAMICS G180 compact units and SINAMICS G180 cabinet systems

SINAMICS G180 compact units

Technical data (continued)

500 V, 6-pulse (continued)

Line voltage, supply system type		230 ... 500 V 3 AC, IT				
SINAMICS G180 compact units		6SE0100-1AD21-8■A7	6SE0100-1AD22-5■A7	6SE0100-1AD23-7■A7	6SE0100-1AD24-8■A7	6SE0100-1AD25-8■A7
Converter type		2T2A-07500-011	2T2A-07500-015	2T2A-07500-022	2T2A-07500-030	2T2A-07500-037
Electrical data at motor end						
Type rating ¹⁾						
• at 50 Hz 500 V	kW	11	15	22	30	37
• at 60 Hz 460 V	hp	17	23	34	46	57
Output voltage ²⁾						
	V	0 ... 0.98 × V _{line}	0 ... 0.98 × V _{line}	0 ... 0.98 × V _{line}	0 ... 0.98 × V _{line}	0 ... 0.98 × V _{line}
Output current						
• Continuous current	A	18	24.5	37	48	58
• Short-time current (60 s every 10 minutes) max.	A	20	27	44	54	63
Overload capability (60 s every 10 minutes) max.						
	%	11	10	19	13	9
Output power						
	kVA	15.6	21.2	32	41.6	50.2
Output frequency, max.						
	Hz	250	250	250	250	250
Rated clock cycle						
	kHz	4.5	4.5	4.5	4.5	4.5
adjustable from	kHz	3 ... 7.5	3 ... 7.5	3 ... 7.5	3 ... 7.5	3 ... 7.5
Power loss ³⁾						
	kW	0.48	0.63	0.89	1.17	1.35
Rated efficiency						
	%	96.2	96.3	96.4	96.5	96.7
Electrical data at line end						
Connected load						
	kVA	16	24.4	32	39.2	52.3
Rated input voltage						
	V	500	500	500	500	500
Input current						
• Continuous line current	A	17.4	23.4	35.8	46.8	57.1
• Short-time line current (60 s) max.	A	19	26	43	53	62
Line fuse (provided by customer)						
	gL (A)	20 ... 32	25 ... 32	40 ... 80	50 ... 80	63 ... 80
λ_{line}						
		0.902	0.924	0.918	0.924	0.912
Cos ϕ_{line}						
		1	1	1	1	1
Radio interference suppression acc. to EN 61800-3						
		C4	C4	C4	C4	C4
Mechanical data						
Coolant requirements						
	m ³ /h	90	130	280	280	280
Sound pressure level L _{pA} (1 m) at 50/60 Hz						
	dB	60	60	60	60	62
Max. cable length between converter and motor with standard insulation						
• (shielded)	m	300 ⁴⁾	300 ⁴⁾	300 ⁴⁾	300 ⁴⁾	300 ⁴⁾
Line/load connection						
L1, L2, L3/U2, V2, W2						
For connection cross-sections, see "Cable cross-sections and connections" in section "Configuring instructions"						
Dimensions						
• Width	mm	165	165	225	225	225
• Height (without mounting brackets)	mm	510	510	610	610	610
• Depth	mm	320	320	320	320	320
Weight, approx.						
	kg	16.5	17.5	30	32	32
Approvals, according to						
		NRTL ⁵⁾	NRTL ⁵⁾	NRTL ⁵⁾	NRTL ⁵⁾	NRTL ⁵⁾
Frame size						
		K2	K2	K3	K3	K3

¹⁾ Rated power of a typical 2- to 6-pole standard motor.

²⁾ Typical output voltage dependent on filter and unit type.

³⁾ Maximum power loss with continuous current.

⁴⁾ Option L10 included (strengthened dv/dt filter; strengthened filter is integrated in unit).

⁵⁾ On request

SINAMICS G180

SINAMICS G180 compact units and SINAMICS G180 cabinet systems

SINAMICS G180 compact units

Technical data (continued)

500 V, 6-pulse (continued)

Line voltage, supply system type		230 ... 500 V 3 AC, IT				
SINAMICS G180 compact units		6SE0100-1AD27-8■A7	6SE0100-1AD28-8■A7	6SE0100-1AD31-1■A7	6SE0100-1AD31-5■A7	6SE0100-1AD31-8■A7
Converter type		2T2A-07500-045	2T2A-07500-055	2T2A-07500-075	2T2A-07500-090	2T2A-07500-110
Electrical data at motor end						
Type rating ¹⁾						
• at 50 Hz 500 V	kW	45	55	75	90	110
• at 60 Hz 460 V	hp	56	68	93	111	136
Output voltage ²⁾						
	V	0 ... 0.98 × V _{line}	0 ... 0.98 × V _{line}	0 ... 0.98 × V _{line}	0 ... 0.98 × V _{line}	0 ... 0.98 × V _{line}
Output current						
• Continuous current	A	78	88	110	145	175
• Short-time current (60 s every 10 minutes) max.	A	88	110	126	165	204
Overload capability (60 s every 10 minutes) max.						
	%	13	25	15	14	17
Output power						
	kVA	67.5	76.2	95.3	126	152
Output frequency, max.						
	Hz	250	250	250	250	250
Rated clock cycle						
	kHz	3	3	3	3	3
adjustable from	kHz	2 ... 5	2 ... 5	2 ... 5	20 ... 5	2 ... 5
Power loss ³⁾						
	kW	1.59	1.8	2.37	2.83	3.33
Rated efficiency						
	%	96.8	97.0	97.1	97.1	97.2
Electrical data at line end						
Connected load						
	kVA	57.5	74.8	98.4	119	136
Rated input voltage						
	V	500	500	500	500	500
Input current						
• Continuous line current	A	73.7	87.6	109	143	170
• Short-time line current (60 s) max.	A	83	110	125	163	198
Line fuse (provided by customer)						
	gL (A)	80 ... 100	100	125	160	200
λ_{line}						
		0.918	0.912	0.918	0.918	0.908
Cos ϕ_{line}						
		1	1	1	1	1
Radio interference suppression acc. to EN 61800-3						
		C4	C4	C4	C4	C4
Mechanical data						
Coolant requirements						
	m ³ /h	750	750	750	1050	1050
Sound pressure level L _{pA} (1 m) at 50/60 Hz						
	dB	62	62	64	64	64
Max. cable length between converter and motor with standard insulation						
• (shielded)	m	300 ⁴⁾	300 ⁴⁾	300 ⁴⁾	300 ⁴⁾	300 ⁴⁾
Line/load connection						
L1, L2, L3/U2, V2, W2						
For connection cross-sections, see "Cable cross-sections and connections" in section "Configuring instructions"						
Dimensions						
• Width	mm	350	350	350	350	350
• Height (without mounting brackets)	mm	710	710	710	1060	1060
• Depth	mm	320	320	320	320	320
Weight, approx.						
	kg	51	53	55	90	94
Approvals, according to						
		NRTL ⁵⁾	NRTL ⁵⁾	NRTL ⁵⁾	NRTL ⁵⁾	NRTL ⁵⁾
Frame size						
		K4	K4	K4	K5	K5

¹⁾ Rated power of a typical 2- to 6-pole standard motor.

²⁾ Typical output voltage dependent on filter and unit type.

³⁾ Maximum power loss with continuous current.

⁴⁾ Option L10 included (strengthened dv/dt filter; strengthened filter is integrated in unit).

⁵⁾ On request

SINAMICS G180

SINAMICS G180 compact units and SINAMICS G180 cabinet systems

SINAMICS G180 compact units

Technical data (continued)

500 V, 6-pulse (continued)

Line voltage, supply system type		230 ... 500 V 3 AC, IT		
SINAMICS G180 compact units		6SE0100-1AD32-1■A7	6SE0100-1AD32-5■A7	6SE0100-1AD33-0■A7
Converter type		2T2A-07500-132	2T2A-07500-160	2T2A-07500-200
Electrical data at motor end				
Type rating¹⁾				
• at 50 Hz 500 V	kW	132	160	200
• at 60 Hz 460 V	hp	163	197	247
Output voltage²⁾		V	0 ... 0.98 × V _{line}	0 ... 0.98 × V _{line}
Output current				
• Continuous current	A	205	245	295
• Short-time current (60 s every 10 minutes) max.	A	240	300	360
Overload capability (60 s every 10 minutes) max.		%	17	22
Output power		kVA	178	212
Output frequency, max.		Hz	250	250
Rated clock cycle		kHz	3	3
adjustable from		kHz	2 ... 5	2 ... 5
Power loss³⁾		kW	3.84	4.48
Rated efficiency		%	97.3	97.4
Electrical data at line end				
Connected load		kVA	161	197
Rated input voltage		V	500	500
Input current				
• Continuous line current	A	196	237	286
• Short-time line current (60 s) max.	A	230	290	349
Line fuse (provided by customer)		gL (A)	200 ... 250	250 ... 315
λ_{line}			0.912	0.912
Cos ϕ_{line}			1	1
Radio interference suppression acc. to EN 61800-3			C4	C4
Mechanical data				
Coolant requirements		m ³ /h	1050	1600
Sound pressure level L_{pA} (1 m) at 50/60 Hz		dB	66	66
Max. cable length between converter and motor with standard insulation				
• (shielded)	m	300 ⁴⁾	300 ⁴⁾	300 ⁴⁾
Line/load connection L1, L2, L3/U2, V2, W2 For connection cross-sections, see "Cable cross-sections and connections" in section "Configuring instructions"				
Dimensions				
• Width	mm	350	500	500
• Height (without mounting brackets)	mm	1060	1060	1060
• Depth	mm	320	320	320
Weight, approx.		kg	96	170
Approvals, according to			NRTL ⁵⁾	NRTL ⁵⁾
Frame size			K5	K6

¹⁾ Rated power of a typical 2- to 6-pole standard motor.

²⁾ Typical output voltage dependent on filter and unit type.

³⁾ Maximum power loss with continuous current.

⁴⁾ Option L10 included (strengthened dv/dt filter; strengthened filter is integrated in unit).

⁵⁾ On request

SINAMICS G180

SINAMICS G180 compact units and SINAMICS G180 cabinet systems

SINAMICS G180 compact units

Technical data (continued)

690 V, 6-pulse

Line voltage, supply system type		230 ... 690 V 3 AC, TT/TN or IT				
SINAMICS G180 compact units		6SE0100-1A21-0A7	6SE0100-1A21-3A7	6SE0100-1A21-8A7	6SE0100-1A22-5A7	6SE0100-1A23-4A7
Converter type		2T2A-07600-007	2T2A-07600-011	2T2A-07600-015	2T2A-07600-022	2T2A-07600-030
Electrical data at motor end						
Type rating ¹⁾						
• at 50 Hz 690 V	kW	7.5	11	15	22	30
• at 60 Hz 575 V	hp	8	12	17	25	34
Output voltage ²⁾						
	V	0 ... 0.98 × V _{line}	0 ... 0.98 × V _{line}	0 ... 0.98 × V _{line}	0 ... 0.98 × V _{line}	0 ... 0.98 × V _{line}
Output current						
• Continuous current	A	9.5	13	18	27	36
• Short-time current (60 s every 10 minutes) max.	A	11	16	21	33	45
Overload capability (60 s every 10 minutes) max.						
	%	16	23	17	22	25
Output power						
	kVA	11.4	15.5	21.5	32.3	43
Output frequency, max.						
	Hz	250	250	250	250	250
Rated clock cycle						
	kHz	3	3	3	3	3
adjustable from	kHz	2 ... 5	2 ... 5	2 ... 5	2 ... 5	2 ... 5
Power loss ³⁾						
	kW	0.29	0.4	0.55	0.74	1
Rated efficiency						
	%	96.7	96.8	96.8	97.0	97.0
Electrical data at line end						
Connected load						
	kVA	3.7	4.6	6.4	8.6	12.1
Rated input voltage						
	V	690	690	690	690	690
Input current						
• Continuous line current	A	8.8	11.8	16.8	25.3	37.3
• Short-time line current (60 s) max.	A	10	14	20	31	47
Line fuse (provided by customer)						
	gL (A)	10 ... 32	16 ... 32	20 ... 32	32	40 ... 63
λ_{line}						
		0.94	0.948	0.94	0.948	0.867
Cos ϕ_{line}						
		1	1	1	1	1
Radio interference suppression acc. to EN 61800-3 ⁴⁾						
		C2 (class A filter)	C2 (class A filter)	C2 (class A filter)	C2 (class A filter)	C2 (class A filter)
Mechanical data						
Coolant requirements						
	m ³ /h	90	90	130	130	750
Sound pressure level L _{pA} (1 m) at 50/60 Hz						
	dB	60	60	60	60	60
Max. cable length between converter and motor with standard insulation						
• (shielded)	m	300 ⁵⁾	300 ⁵⁾	300 ⁵⁾	300 ⁵⁾	300 ⁵⁾
Line/load connection						
L1, L2, L3/U2, V2, W2						
For connection cross-sections, see "Cable cross-sections and connections" in section "Configuring instructions"						
Dimensions						
• Width	mm	225	225	225	225	350
• Height (without mounting brackets)	mm	610	610	610	610	710
• Depth	mm	320	320	320	320	320
Weight, approx.						
	kg	26	26	28	28	55
Approvals, according to						
		NRTL ⁶⁾	NRTL ⁶⁾	NRTL ⁶⁾	NRTL ⁶⁾	NRTL ⁶⁾
Frame size						
		K3	K3	K3	K3	K4

1) Rated power of a typical 2- to 6-pole standard motor.

2) Typical output voltage dependent on filter and unit type.

3) Maximum power loss with continuous current.

4) EMC filter not required for IT system, in which case RI suppression category C4.

5) Value is applicable with option L10 (strengthened dv/dt filter; strengthened filter is integrated in unit).

6) On request; the voltage range for NRTL units ends at max. 600 V.

SINAMICS G180

SINAMICS G180 compact units and SINAMICS G180 cabinet systems

SINAMICS G180 compact units

Technical data (continued)

690 V, 6-pulse (continued)

Line voltage, supply system type		230 ... 690 V 3 AC, TT/TN or IT				
SINAMICS G180 compact units		6SE0100-1A24-2A7	6SE0100-1A25-0A7	6SE0100-1A25-8A7	6SE0100-1A28-0A7	6SE0100-1A31-0A7
Converter type		2T2A-07600-037	2T2A-07600-045	2T2A-07600-055	2T2A-07600-075	2T2A-07600-090
Electrical data at motor end						
Type rating ¹⁾						
• at 50 Hz 690 V	kW	37	45	55	75	90
• at 60 Hz 575 V	hp	41	50	62	84	101
Output voltage ²⁾						
	V	0 ... 0.98 × V _{line}	0 ... 0.98 × V _{line}	0 ... 0.98 × V _{line}	0 ... 0.98 × V _{line}	0 ... 0.98 × V _{line}
Output current						
• Continuous current	A	43	50	60	80	95
• Short-time current (60 s every 10 minutes) max.	A	55	65	75	90	120
Overload capability (60 s every 10 minutes) max.						
	%	28	30	25	13	26
Output power						
	kVA	51.4	59.8	71.7	95.6	114
Output frequency, max.						
	Hz	250	250	250	250	250
Rated clock cycle						
	kHz	3	3	3	3	3
adjustable from	kHz	2 ... 5	2 ... 5	2 ... 5	2 ... 5	2 ... 5
Power loss ³⁾						
	kW	1.19	1.44	1.68	2.28	2.63
Rated efficiency						
	%	97.1	97.1	97.2	97.2	97.3
Electrical data at line end						
Connected load						
	kVA	16	24.4	32	39.2	52.3
Rated input voltage						
	V	690	690	690	690	690
Input current						
• Continuous line current	A	42.9	50.1	60.7	80.9	102
• Short-time line current (60 s) max.	A	55	65	76	91	129
Line fuse (provided by customer)						
	gL (A)	50 ... 63	63	63 ... 80	100	125
λ_{line}						
		0.898	0.863	0.894	0.896	0.845
Cos ϕ_{line}						
		1	1	1	1	1
Radio interference suppression acc. to EN 61800-3 ⁴⁾						
		C2 (class A filter)	C2 (class A filter)	C2 (class A filter)	C2 (class A filter)	C2 (class A filter)
Mechanical data						
Coolant requirements						
	m ³ /h	750	750	750	750	1050
Sound pressure level L _{pA} (1 m) at 50/60 Hz						
	dB	60	60	60	60	62
Max. cable length between converter and motor with standard insulation						
• (shielded)	m	300 ⁵⁾	300 ⁵⁾	300 ⁵⁾	300 ⁵⁾	150 (300) ⁶⁾
Line/load connection						
L1, L2, L3/U2, V2, W2						
For connection cross-sections, see "Cable cross-sections and connections" in section "Configuring instructions"						
Dimensions						
• Width	mm	350	350	350	350	350
• Height (without mounting brackets)	mm	710	710	710	710	1060
• Depth	mm	320	320	320	320	320
Weight, approx.						
	kg	55	59	59	59	90
Approvals, according to						
		NRTL ⁷⁾	NRTL ⁷⁾	NRTL ⁷⁾	NRTL ⁷⁾	NRTL ⁷⁾
Frame size						
		K4	K4	K4	K4	K5

¹⁾ Rated power of a typical 2- to 6-pole standard motor.

²⁾ Typical output voltage dependent on filter and unit type.

³⁾ Maximum power loss with continuous current.

⁴⁾ EMC filter not required for IT system, in which case RI suppression category C4.

⁵⁾ Value is applicable with option L10 (strengthened dv/dt filter; strengthened filter is integrated in unit).

⁶⁾ Value is applicable with option L10 (strengthened dv/dt filter; strengthened filter is supplied separately with unit).

⁷⁾ On request; the voltage range for NRTL units ends at max. 600 V.

SINAMICS G180

SINAMICS G180 compact units and SINAMICS G180 cabinet systems

SINAMICS G180 compact units

Technical data (continued)

690 V, 6-pulse (continued)

Line voltage, supply system type		230 ... 690 V 3 AC, TT/TN or IT			
SINAMICS G180 compact units		6SE0100-1A31-2A7	6SE0100-1A31-4A7	6SE0100-1A31-7A7	6SE0100-1A32-1A7
Converter type		2T2A-07600-110	2T2A-07600-132	2T2A-07600-160	2T2A-07600-200
Electrical data at motor end					
Type rating ¹⁾					
• at 50 Hz 690 V	kW	110	132	160	200
• at 60 Hz 575 V	hp	122	148	179	224
Output voltage ²⁾					
	V	0 ... 0.98 × V _{line}	0 ... 0.98 × V _{line}	0 ... 0.98 × V _{line}	0 ... 0.98 × V _{line}
Output current					
• Continuous current	A	120	150	175	210
• Short-time current (60 s every 10 minutes) max.	A	140	175	210	255
Overload capability (60 s every 10 minutes) max.					
	%	17	17	20	21
Output power					
	kVA	143	179	209	251
Output frequency, max.					
	Hz	250	250	250	250
Rated clock cycle					
	kHz	3	3	3	3
adjustable from	kHz	2 ... 5	2 ... 5	2 ... 5	2 ... 5
Power loss ³⁾					
	kW	3.21	3.7	4.48	5.38
Rated efficiency					
	%	97.3	97.4	97.4	97.5
Electrical data at line end					
Connected load					
	kVA	57.5	74.8	98.4	119
Rated input voltage					
	V	690	690	690	690
Input current					
• Continuous line current	A	119	153	180	222
• Short-time line current (60 s) max.	A	139	178	216	270
Line fuse (provided by customer)					
	gL (A)	125 ... 160	160 ... 200	200 ... 250	250 ... 315
λ_{line}					
		0.883	0.857	0.862	0.838
Cos ϕ_{line}					
		1	1	1	1
Radio interference suppression acc. to EN 61800-3					
		C2 (class A filter)	C2 (class A filter)	C2 (class A filter)	C2 (class A filter)
Mechanical data					
Coolant requirements					
	m ³ /h	1050	1050	1600	1600
Sound pressure level L _{pA} (1 m) at 50/60 Hz					
	dB	62	62	64	64
Max. cable length between converter and motor with standard insulation					
• (shielded)	m	150/300 ⁴⁾	150/300 ⁴⁾	150/300 ⁴⁾	150/300 ⁴⁾
Line/load connection					
L1, L2, L3/U2, V2, W2					
For connection cross-sections, see "Cable cross-sections and connections" in section "Configuring instructions"					
Dimensions					
• Width	mm	350	350	500	500
• Height (without mounting brackets)	mm	1060	1060	1060	1060
• Depth	mm	320	320	320	320
Weight, approx.					
	kg	94	96	170	180
Approvals, according to					
		NRTL ⁵⁾	NRTL ⁵⁾	NRTL ⁵⁾	NRTL ⁵⁾
Frame size					
		K5	K5	K6	K6

¹⁾ Rated power of a typical 2- to 6-pole standard motor.

²⁾ Typical output voltage dependent on filter and unit type.

³⁾ Maximum power loss with continuous current.

⁴⁾ Value is applicable with option L10 (strengthened dv/dt filter; strengthened filter is supplied separately with unit).

⁵⁾ On request; the voltage range for NRTL units ends at max. 600 V.

Selection and ordering data

400 V, 6-pulse

SINAMICS G180 compact unit (230 to 500 V 3 AC TN/TT system, 50 to 60 Hz)

Converter type	Connected load kVA	Output		Type rating ²⁾ kW	SINAMICS G180 compact units Article No.	Version (for option selection)
		Continuous current A	Short-time current ¹⁾ A			
2T2A-07400-002	3.7	5.5	6.5	2.2	6SE0100-1AC15-5 ■ A7	A
2T2A-07400-003	4.6	7	8	3	6SE0100-1AC17-0 ■ A7	A
2T2A-07400-004	6.4	9.5	11	4	6SE0100-1AC21-0 ■ A7	A
2T2A-07400-005	8.6	13	15	5.5	6SE0100-1AC21-3 ■ A7	A
2T2A-07400-007	12.1	18	20	7.5	6SE0100-1AC21-8 ■ A7	A
2T2A-07400-011	16	24.5	27	11	6SE0100-1AC22-5 ■ A7	A
2T2A-07400-015	24.4	37	44	15	6SE0100-1AC23-7 ■ A7	B
2T2A-07400-022	32	48	54	22	6SE0100-1AC24-8 ■ A7	B
2T2A-07400-030	39.2	58	63	30	6SE0100-1AC25-8 ■ A7	B
2T2A-07400-037	52.3	78	88	37	6SE0100-1AC27-8 ■ A7	B
2T2A-07400-045	57.5	88	110	45	6SE0100-1AC28-8 ■ A7	B
2T2A-07400-055	74.8	110	126	55	6SE0100-1AC31-1 ■ A7	B
2T2A-07400-075	98.4	145	165	75	6SE0100-1AC31-5 ■ A7	C
2T2A-07400-090	119	175	204	90	6SE0100-1AC31-8 ■ A7	C
2T2A-07400-110	136	205	240	110	6SE0100-1AC32-1 ■ A7	C
2T2A-07400-132	161	245	300	132	6SE0100-1AC32-5 ■ A7	D
2T2A-07400-160	197	295	360	160	6SE0100-1AC33-0 ■ A7	D

See article number code on Page 2/17

500 V, 6-pulse

SINAMICS G180 compact unit (230 to 500 V 3 AC IT system, 50 to 60 Hz)

Converter type	Connected load kVA	Output		Type rating ²⁾ kW	SINAMICS G180 compact units Article No.	Version (for option selection)
		Continuous current A	Short-time current ¹⁾ A			
2T2A-07500-002	3.8	4.5	5	2.2	6SE0100-1AD14-5 ■ A7	E
2T2A-07500-003	4.5	5.5	6.5	3	6SE0100-1AD15-5 ■ A7	E
2T2A-07500-004	5.8	7	8	4	6SE0100-1AD17-0 ■ A7	E
2T2A-07500-005	8.2	9.5	11	5.5	6SE0100-1AD21-0 ■ A7	E
2T2A-07500-007	10.9	13	15	7.5	6SE0100-1AD21-3 ■ A7	E
2T2A-07500-011	15.2	18	20	11	6SE0100-1AD21-8 ■ A7	E
2T2A-07500-015	20.4	24.5	27	15	6SE0100-1AD22-5 ■ A7	E
2T2A-07500-022	31.3	37	44	22	6SE0100-1AD23-7 ■ A7	F
2T2A-07500-030	40.5	48	54	30	6SE0100-1AD24-8 ■ A7	F
2T2A-07500-037	49.6	58	63	37	6SE0100-1AD25-8 ■ A7	F
2T2A-07500-045	64.2	78	88	45	6SE0100-1AD27-8 ■ A7	F
2T2A-07500-055	76.1	88	110	55	6SE0100-1AD28-8 ■ A7	F
2T2A-07500-075	94.4	110	126	75	6SE0100-1AD31-1 ■ A7	F
2T2A-07500-090	124	145	165	90	6SE0100-1AD31-5 ■ A7	G
2T2A-07500-110	147	175	204	110	6SE0100-1AD31-8 ■ A7	G
2T2A-07500-132	171	205	240	132	6SE0100-1AD32-1 ■ A7	G
2T2A-07500-160	206	245	300	160	6SE0100-1AD32-5 ■ A7	H
2T2A-07500-200	248	295	360	200	6SE0100-1AD33-0 ■ A7	H

See article number code on Page 2/17

1) Short-time current for 60 s every 10 minutes.

2) Rated power of a typical 2- to 6-pole standard motor.

SINAMICS G180

SINAMICS G180 compact units and SINAMICS G180 cabinet systems

SINAMICS G180 compact units

Selection and ordering data (continued)

690 V, 6-pulse

SINAMICS G180 compact unit (230 to 600/690 V 3 AC TN/TT system, 50 to 60 Hz)¹⁾

Converter type	Connected load kVA	Output			SINAMICS G180 compact units Article No.	Version (for option selection)
		Continuous current A	Short-time current ²⁾ A	Type rating ³⁾ kW		
2T2A-07600-007	10.8	9.5	11	7.5	6SE0100-1AG21-0 ■ A7	I
2T2A-07600-011	14.3	13	16	11	6SE0100-1AG21-3 ■ A7	I
2T2A-07600-015	20.3	18	21	15	6SE0100-1AG21-8 ■ A7	I
2T2A-07600-022	30.5	27	33	22	6SE0100-1AG22-5 ■ A7	I
2T2A-07600-030	45.5	36	45	30	6SE0100-1AG23-4 ■ A7	J
2T2A-07600-037	52.6	43	55	37	6SE0100-1AG24-2 ■ A7	J
2T2A-07600-045	60.9	50	65	45	6SE0100-1AG25-0 ■ A7	J
2T2A-07600-055	74	60	75	55	6SE0100-1AG25-8 ■ A7	J
2T2A-07600-075	97.9	80	90	75	6SE0100-1AG28-0 ■ A7	J
2T2A-07600-090	123	95	120	90	6SE0100-1AG31-0 ■ A7	K
2T2A-07600-110	143	120	140	110	6SE0100-1AG31-2 ■ A7	K
2T2A-07600-132	184	150	175	132	6SE0100-1AG31-4 ■ A7	K
2T2A-07600-160	216	175	210	160	6SE0100-1AG31-7 ■ A7	L
2T2A-07600-200	266	210	255	200	6SE0100-1AG32-1 ■ A7	L

See article number code on Page 2/17

SINAMICS G180 compact unit (230 to 600/690 V 3 AC IT system, 50 to 60 Hz)¹⁾

Converter type	Connected load kVA	Output			SINAMICS G180 compact units Article No.	Version (for option selection)
		Continuous current A	Short-time current ²⁾ A	Type rating ³⁾ kW		
2T2A-07600-007	10.8	9.5	11	7.5	6SE0100-1AH21-0 ■ A7	M
2T2A-07600-011	14.3	13	16	11	6SE0100-1AH21-3 ■ A7	M
2T2A-07600-015	20.3	18	21	15	6SE0100-1AH21-8 ■ A7	M
2T2A-07600-022	30.5	27	33	22	6SE0100-1AH22-5 ■ A7	M
2T2A-07600-030	45.5	36	45	30	6SE0100-1AH23-4 ■ A7	N
2T2A-07600-037	52.6	43	55	37	6SE0100-1AH24-2 ■ A7	N
2T2A-07600-045	60.9	50	65	45	6SE0100-1AH25-0 ■ A7	N
2T2A-07600-055	74	60	75	55	6SE0100-1AH25-8 ■ A7	N
2T2A-07600-075	97.9	80	90	75	6SE0100-1AH28-0 ■ A7	N
2T2A-07600-090	123	95	120	90	6SE0100-1AH31-0 ■ A7	O
2T2A-07600-110	143	120	140	110	6SE0100-1AH31-2 ■ A7	O
2T2A-07600-132	184	150	175	132	6SE0100-1AH31-4 ■ A7	O
2T2A-07600-160	216	175	210	160	6SE0100-1AH31-7 ■ A7	P
2T2A-07600-200	266	210	255	200	6SE0100-1AH32-1 ■ A7	P

See article number code on Page 2/17

¹⁾ With an NRTL unit ("U" in 14th position of article number), the voltage range ends at maximum 600 V, otherwise at 690 V.

³⁾ Rated power of a typical 2- to 6-pole standard motor.

²⁾ Short-time current for 60 s every 10 minutes.

SINAMICS G180

SINAMICS G180 compact units and SINAMICS G180 cabinet systems

SINAMICS G180 compact units

Selection and ordering data (continued)

Article number code

Position of Article No.	1	2	3	4	5	6	7	8	9	10	11	12	13	14	15	16	
SINAMICS G180 compact unit	6	S	E	0	1	0	0	-	-	.	■	A	.
Line harmonics																	
6-pulse									1								
System																	
Compact unit										A							
Supply voltage																	
230 ... 500 V 3 AC TN/TT, 50 ... 60 Hz																	C
230 ... 500 V 3 AC IT, 50 ... 60 Hz																	D
230 ... 600/690 V 3 AC ¹⁾ TN/TT, 50 ... 60 Hz																	G
230 ... 600/690 V 3 AC ¹⁾ IT, 50 ... 60 Hz																	H
Option module																	
IEC, EN																	A
NRTL-certified according to UL 508C ²⁾ (by TÜV and/or UL)																	U
Version/release number																	
Version/release number T7																	7

Number code for converter type

Position of <i>converter type</i> No.	1	2	3	4	5	6	7	8	9	10	11	12
SINAMICS G180 compact unit	2	T	.	.	-	-	.	.
Degree of protection												
IP20			2									
IP21			3									
Number of pulses in the input												
6-pulse input, corresponds to UL by TÜV ²⁾				A								
Mechanical design												
Compact device with air cooling						0						
Modification status												
Modification status 7							7					
Line voltage												
400 V unit								4				
500 V unit								5				
690 V unit								6				
Number of parallel line-converter systems												
Single device without system management										0		
Number of parallel machine-converter systems												
Single device without system management											0	
Achievable type rating in kW with continuous output current												
If the 10th position of the article number is "9", the other two digits show the type rating in kW × 100.										.	.	.

¹⁾ With an NRTL unit ("U" in 14th position of article number), the voltage range ends at maximum 600 V, otherwise at 690 V.

²⁾ Not yet available, on request.

SINAMICS G180

SINAMICS G180 compact units and SINAMICS G180 cabinet systems

SINAMICS G180 compact units

Options

The following tables provide an overview of the options and their availability for SINAMICS G180 compact units with a supply voltage of 400 V, 500 V or 690 V. (For details, see catalog chapter 4 "Option descriptions".)

Option text	Additional ordering data -Z with order code and, if necessary, with plain text specification	SINAMICS G180 compact units															
		400 V TN/TT system				500 V IT system				690 V TN/TT system				690 V IT system			
Version – see selection and ordering data																	
		A	B	C	D	E	F	G	H	I	J	K	L	M	N	O	P
External control voltage supply																	
Connection for 230 V 1 AC 50 Hz control voltage provided by customer, without UPS backup	C56	✓	✓	✓	✓	✓	✓	✓	✓	✓	✓	✓	✓	✓	✓	✓	✓
Connection for 230 V 1 AC 50 Hz control voltage provided by customer, with UPS backup	C57	✓	✓	✓	✓	✓	✓	✓	✓	✓	✓	✓	✓	✓	✓	✓	✓
RFI suppression filter																	
RFI suppression filter, category C2 or C3 (class A)	L00	□	□	□	□	–	–	–	–	□	□	□	□	–	–	–	–
RFI suppression filter, category C1 (class B)	L02	✓	✓	✓	✓	–	–	–	–	–	–	–	–	–	–	–	–
Line Harmonics Filter																	
Line Harmonics Filter for 50 Hz line frequency (supplied separately packed)	L03	✓	✓	✓	✓	✓	✓	✓	✓	✓	✓	✓	✓	✓	✓	✓	✓
Line Harmonics Filter for 60 Hz line frequency up to 480 V (supplied separately packed)	L04	✓	✓	✓	✓	✓	✓	✓	✓	✓	✓	✓	✓	✓	✓	✓	✓
Output filter																	
Strengthened dv/dt output filter for max. 250/300 m (type-dependent). Design for longer motor cables available on request	L10	✓	✓	✓	✓	□	□	□	□	□	□	✓ ¹⁾	✓ ¹⁾	□	□	✓ ¹⁾	✓ ¹⁾
Sine-wave filter IP00 for compact unit, suitable for motor frequencies of ≤ 75 Hz, voltage drop of approximately 5 % of line voltage (supplied separately packed)	L16	✓	✓	✓	✓	✓	✓	✓	✓	✓	✓	✓	✓	✓	✓	✓	✓
Standard accessories packages																	
Main switch integrated into compact unit (might alter dimensions of unit)	S41	✓	✓	✓ ²⁾	–	✓	✓	✓ ²⁾	–	✓	✓	✓ ²⁾	–	✓	✓	✓ ²⁾	–
Braking chopper																	
Braking chopper integrated into converter (braking resistor is not included and must be ordered separately)	L72	□	✓	✓	✓	□	✓	✓	✓	✓	✓	✓	✓	✓	✓	✓	✓
Degrees of protection																	
Increased degree of protection IP21 for compact units	M21	✓	✓	✓	✓	✓	✓	✓	✓	✓	✓	✓	✓	✓	✓	✓	✓
Other options																	
Board for mains supply backup	E85	x	x	x	x	x	x	x	x	□	✓	✓	✓	□	✓	✓	✓
External 4-line operator panel, supplied separately packed	K14	✓	✓	✓	✓	✓	✓	✓	✓	✓	✓	✓	✓	✓	✓	✓	✓
Peripheral boards																	
Peripheral board 1	G02	✓	✓	✓	✓	✓	✓	✓	✓	✓	✓	✓	✓	✓	✓	✓	✓
Peripheral board 2	G03	✓	✓	✓	✓	✓	✓	✓	✓	✓	✓	✓	✓	✓	✓	✓	✓
Peripheral board 3	G04	✓	✓	✓	✓	✓	✓	✓	✓	✓	✓	✓	✓	✓	✓	✓	✓
Peripheral board 4	G05	✓	✓	✓	✓	✓	✓	✓	✓	✓	✓	✓	✓	✓	✓	✓	✓
Additional boards for bus connection																	
Board for PROFIBUS DPV1	G01	✓	✓	✓	✓	✓	✓	✓	✓	✓	✓	✓	✓	✓	✓	✓	✓
Board for CANopen	G20	✓	✓	✓	✓	✓	✓	✓	✓	✓	✓	✓	✓	✓	✓	✓	✓
Board for Modbus RTU	G22	✓	✓	✓	✓	✓	✓	✓	✓	✓	✓	✓	✓	✓	✓	✓	✓
Board for Modbus TCP	G27	✓	✓	✓	✓	✓	✓	✓	✓	✓	✓	✓	✓	✓	✓	✓	✓
Accessories for IMS																	
USB PROFIBUS interface (supplied separately packed)	G13	✓	✓	✓	✓	✓	✓	✓	✓	✓	✓	✓	✓	✓	✓	✓	✓
Ethernet-PROFIBUS gateway	G14	✓	✓	✓	✓	✓	✓	✓	✓	✓	✓	✓	✓	✓	✓	✓	✓
Ethernet-to-RS232/485/422 converter (supplied separately packed)	G15	✓	✓	✓	✓	✓	✓	✓	✓	✓	✓	✓	✓	✓	✓	✓	✓
USB cable A/B (supplied separately packed)	G16	✓	✓	✓	✓	✓	✓	✓	✓	✓	✓	✓	✓	✓	✓	✓	✓

For legends and footnotes, see Page 2/20.

SINAMICS G180 compact units and SINAMICS G180 cabinet systems

SINAMICS G180 compact units

Options (continued)

Option text	Additional ordering data -Z with order code and, if necessary, with plain text specification	SINAMICS G180 compact units															
		400 V TN/TT system				500 V IT system				690 V TN/TT system				690 V IT system			
		Version – see selection and ordering data															
		A	B	C	D	E	F	G	H	I	J	K	L	M	N	O	P
Extension of the liability for defects																	
Extension of the liability for defects by 12 months as of commissioning date or by 24 months as of delivery date	Q80	✓	✓	✓	✓	✓	✓	✓	✓	✓	✓	✓	✓	✓	✓	✓	✓
Extension of the liability for defects by 18 months as of commissioning date or by 30 months as of delivery date	Q81	✓	✓	✓	✓	✓	✓	✓	✓	✓	✓	✓	✓	✓	✓	✓	✓
Extension of the liability for defects by 24 months as of commissioning date or by 36 months as of delivery date	Q82	✓	✓	✓	✓	✓	✓	✓	✓	✓	✓	✓	✓	✓	✓	✓	✓
Extension of the liability for defects by 30 months as of commissioning date or by 42 months as of delivery date	Q83	✓	✓	✓	✓	✓	✓	✓	✓	✓	✓	✓	✓	✓	✓	✓	✓
Extension of the liability for defects by 36 months as of commissioning date or by 48 months as of delivery date	Q84	✓	✓	✓	✓	✓	✓	✓	✓	✓	✓	✓	✓	✓	✓	✓	✓
Extension of the liability for defects by 48 months as of commissioning date or by 60 months as of delivery date	Q85	✓	✓	✓	✓	✓	✓	✓	✓	✓	✓	✓	✓	✓	✓	✓	✓
Label for plant identification																	
Cabinet designation TAG/ITEM number according to ordering data	T01	✓	✓	✓	✓	✓	✓	✓	✓	✓	✓	✓	✓	✓	✓	✓	✓
Customized labels	Y33	✓	✓	✓	✓	✓	✓	✓	✓	✓	✓	✓	✓	✓	✓	✓	✓
Ambient temperature for air-cooled converters																	
45 °C ambient temperature (with corresponding derating)	V61	✓	✓	✓	✓	✓	✓	✓	✓	✓	✓	✓	✓	✓	✓	✓	✓
50 °C ambient temperature (with corresponding derating)	V62	✓	✓	✓	✓	✓	✓	✓	✓	✓	✓	✓	✓	✓	✓	✓	✓
55 °C ambient temperature (for compact units with corresponding derating only)	V63	✓	✓	✓	✓	✓	✓	✓	✓	✓	✓	✓	✓	✓	✓	✓	✓
Installation altitude																	
Installation altitude max. 1500 m above sea level (with corresponding derating)	V86	✓	✓	✓	✓	✓	✓	✓	✓	✓	✓	✓	✓	✓	✓	✓	✓
Installation altitude max. 2000 m above sea level (with corresponding derating)	V87	✓	✓	✓	✓	✓	✓	✓	✓	✓	✓	✓	✓	✓	✓	✓	✓
Installation altitude max. 2500 m above sea level (with corresponding derating)	V88	✓	✓	✓	✓	✓	✓	✓	✓	✓	✓	✓	✓	✓	✓	✓	✓
Installation altitude max. 3000 m above sea level (with corresponding derating)	V89	✓	✓	✓	✓	✓	✓	✓	✓	✓	✓	✓	✓	✓	✓	✓	✓
Acceptance tests for converters																	
Routine test under no-load conditions with customer present	F71	✓	✓	✓	✓	✓	✓	✓	✓	✓	✓	✓	✓	✓	✓	✓	✓
Routine test with 1PS or 1MD motor (ordered with converter in package), under no-load conditions (without customer present)	F72	✓	✓	✓	✓	✓	✓	✓	✓	✓	✓	✓	✓	✓	✓	✓	✓
Routine test with 1PS or 1MD motor (ordered with converter in package), under no-load conditions with customer present	F73	✓	✓	✓	✓	✓	✓	✓	✓	✓	✓	✓	✓	✓	✓	✓	✓
Visual inspection and function test under rated load using test bay motor (without customer present)	F80	✓	✓	✓	✓	✓	✓	✓	✓	✓	✓	✓	✓	✓	✓	✓	✓
Visual inspection and function test under rated load using test bay motor with customer present	F81	✓	✓	✓	✓	✓	✓	✓	✓	✓	✓	✓	✓	✓	✓	✓	✓
Visual inspection and function test under rated load with 1PS or 1MD motor (ordered with converter in package) (without customer present)	F82	✓	✓	✓	✓	✓	✓	✓	✓	✓	✓	✓	✓	✓	✓	✓	✓
Visual inspection and function test under rated load with 1PS or 1MD motor (ordered with converter in package) with customer present	F83	✓	✓	✓	✓	✓	✓	✓	✓	✓	✓	✓	✓	✓	✓	✓	✓

For legends and footnotes, see Page 2/20.

SINAMICS G180

SINAMICS G180 compact units and SINAMICS G180 cabinet systems

SINAMICS G180 compact units

Options (continued)

Option text	Additional ordering data -Z with order code and, if necessary, with plain text specification	SINAMICS G180 compact units															
		400 V TN/TT system				500 V IT system				690 V TN/TT system				690 V IT system			
Version – see selection and ordering data		A	B	C	D	E	F	G	H	I	J	K	L	M	N	O	P
Acceptance tests for converters (continued)																	
Advanced visual inspection and function test under rated load with 1PS or 1MD motor (ordered with converter in package) (without customer present)	F84	✓	✓	✓	✓	✓	✓	✓	✓	✓	✓	✓	✓	✓	✓	✓	✓
Advanced visual inspection and function test under rated load with 1PS or 1MD motor (ordered with converter in package) with customer present	F85	✓	✓	✓	✓	✓	✓	✓	✓	✓	✓	✓	✓	✓	✓	✓	✓
Supplementary documentation																	
Test sequence schedule	B48	✓	✓	✓	✓	✓	✓	✓	✓	✓	✓	✓	✓	✓	✓	✓	✓
Spare parts price list	B38	✓	✓	✓	✓	✓	✓	✓	✓	✓	✓	✓	✓	✓	✓	✓	✓
Converter display language																	
Display language Norwegian/English	T23	✓	✓	✓	✓	✓	✓	✓	✓	✓	✓	✓	✓	✓	✓	✓	✓
Display language Swedish/English	T24	✓	✓	✓	✓	✓	✓	✓	✓	✓	✓	✓	✓	✓	✓	✓	✓
Display language Czech/English	T25	✓	✓	✓	✓	✓	✓	✓	✓	✓	✓	✓	✓	✓	✓	✓	✓
Display language Hungarian/English	T26	✓	✓	✓	✓	✓	✓	✓	✓	✓	✓	✓	✓	✓	✓	✓	✓
Display language French/English	T58	✓	✓	✓	✓	✓	✓	✓	✓	✓	✓	✓	✓	✓	✓	✓	✓
Display language Spanish/English	T60	✓	✓	✓	✓	✓	✓	✓	✓	✓	✓	✓	✓	✓	✓	✓	✓
Display language German/English	T74	✓	✓	✓	✓	✓	✓	✓	✓	✓	✓	✓	✓	✓	✓	✓	✓
Display language English/German	T76	✓	✓	✓	✓	✓	✓	✓	✓	✓	✓	✓	✓	✓	✓	✓	✓
Display language Portuguese/English	T82	✓	✓	✓	✓	✓	✓	✓	✓	✓	✓	✓	✓	✓	✓	✓	✓
Display language Russian/English	T85	✓	✓	✓	✓	✓	✓	✓	✓	✓	✓	✓	✓	✓	✓	✓	✓
Display language Polish/English	T86	✓	✓	✓	✓	✓	✓	✓	✓	✓	✓	✓	✓	✓	✓	✓	✓
Language of assembly and operating instructions																	
Different language for assembly and operating instructions	Y13 • and identification code	✓	✓	✓	✓	✓	✓	✓	✓	✓	✓	✓	✓	✓	✓	✓	✓
Certifications																	
Gost R certificate	U04	✓	✓	✓	✓	✓	✓	✓	✓	✓	✓	✓	✓	✓	✓	✓	✓
Engineering (for description, see Page 4/34)																	
Extended overvoltage range		✓	✓	✓	✓	– ³⁾	– ³⁾	– ³⁾	– ³⁾	✓	✓	✓	✓	✓	✓	✓	✓

✓ Available

□ Standard version

– Not possible

× Not required

• This order code only determines the price of the version – additional plain text is required.

¹⁾ More powerful dv/dt output filter is supplied separately packed with the compact unit.

²⁾ Frame size K51

³⁾ 690 V compact units + the next-higher rating must be selected for the "Extended overvoltage range" function.

SINAMICS G180

SINAMICS G180 compact units and SINAMICS G180 cabinet systems

SINAMICS G180 compact units

Dimensional drawings

Frame size K1

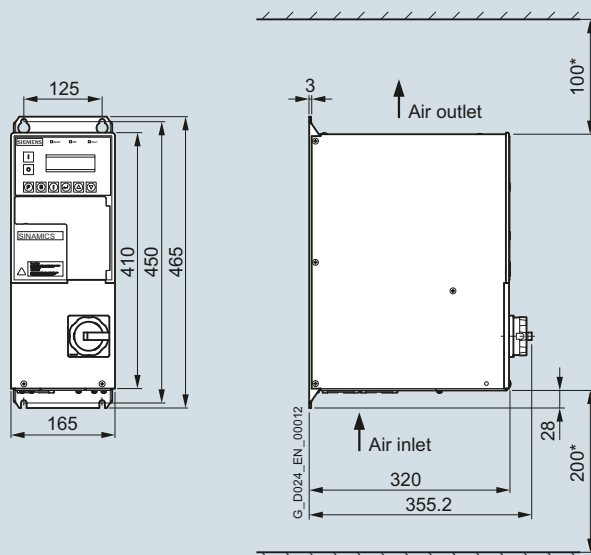

* Minimum clearance for air inlet and air outlet

Main switch is integrated in the compact unit only with option **S41**.

SINAMICS G180 compact units	Converter type
6SE0100-1AC15-5■A7	2T2A-07400-002
6SE0100-1AC17-0■A7	2T2A-07400-003
6SE0100-1AC21-0■A7	2T2A-07400-004
6SE0100-1AC21-3■A7	2T2A-07400-005
6SE0100-1AD14-5■A7	2T2A-07500-002
6SE0100-1AD15-5■A7	2T2A-07500-003
6SE0100-1AD17-0■A7	2T2A-07500-004
6SE0100-1AD21-0■A7	2T2A-07500-005
6SE0100-1AD21-3■A7	2T2A-07500-007

SINAMICS G180

SINAMICS G180 compact units and SINAMICS G180 cabinet systems

SINAMICS G180 compact units

Dimensional drawings (continued)

Frame size K2

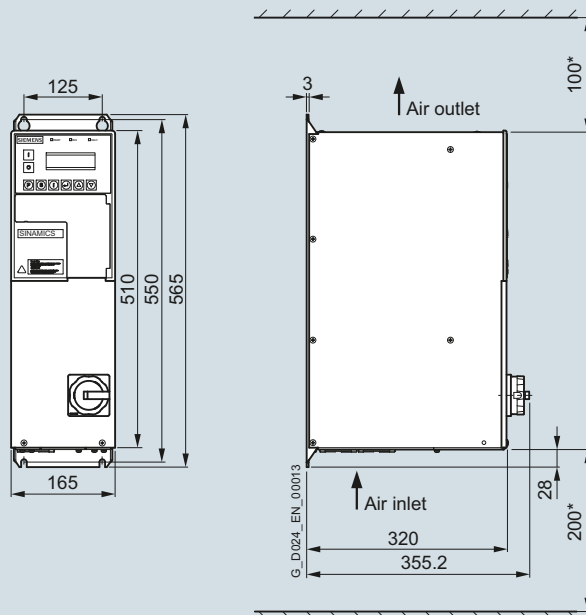

Main switch is integrated in the compact unit only with option **S41**.

SINAMICS G180 compact units	Converter type
6SE0100-1AC21-8■A7	2T2A-07400-007
6SE0100-1AC22-5■A7	2T2A-07400-011
6SE0100-1AD21-8■A7	2T2A-07500-011
6SE0100-1AD22-5■A7	2T2A-07500-015

SINAMICS G180

SINAMICS G180 compact units and SINAMICS G180 cabinet systems

SINAMICS G180 compact units

Dimensional drawings (continued)

Frame size K3

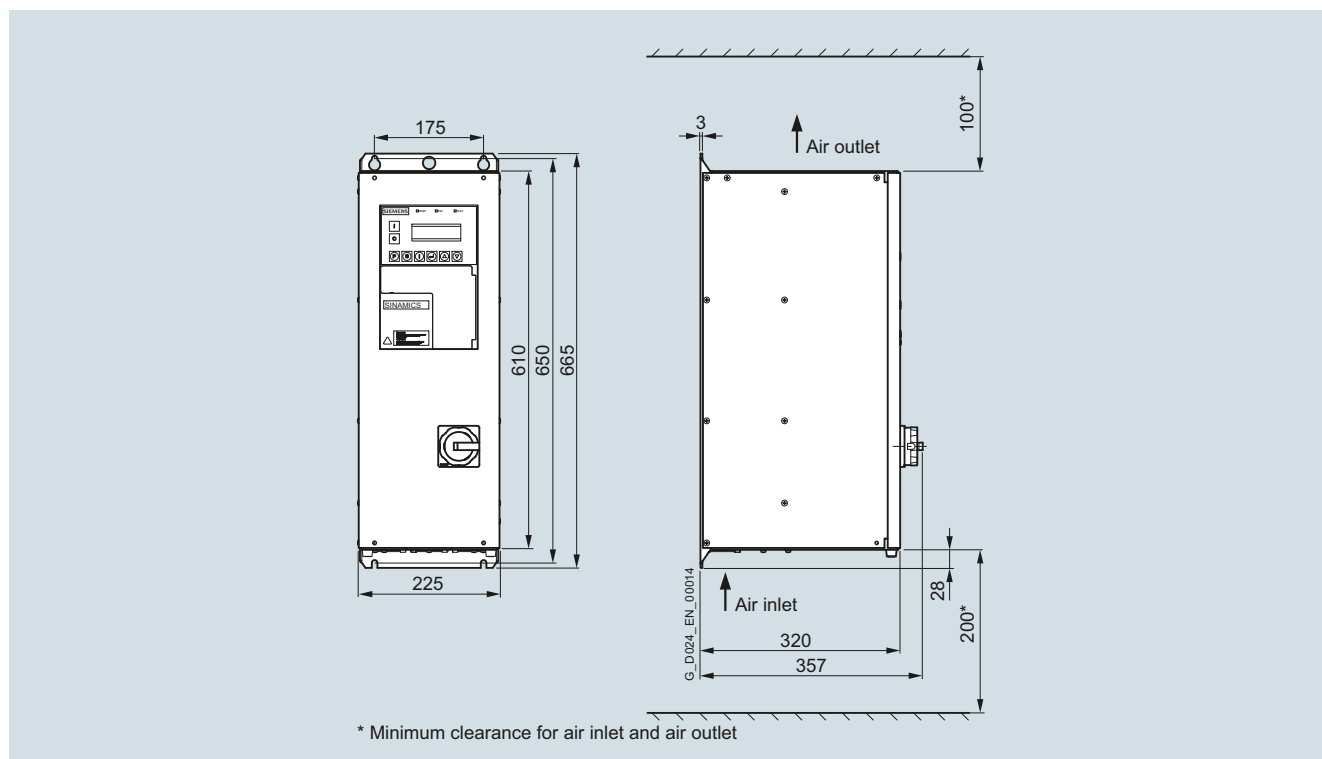

Main switch is integrated in the compact unit only with option **S41**.

SINAMICS G180 compact units	Converter type
6SE0100-1AC23-7■A7	2T2A-07400-015
6SE0100-1AC24-8■A7	2T2A-07400-022
6SE0100-1AC25-8■A7	2T2A-07400-030
6SE0100-1AD23-7■A7	2T2A-07500-022
6SE0100-1AD24-8■A7	2T2A-07500-030
6SE0100-1AD25-8■A7	2T2A-07500-037
6SE0100-1A■21-0■A7	2T2A-07600-007
6SE0100-1A■21-3■A7	2T2A-07600-011
6SE0100-1A■21-8■A7	2T2A-07600-015
6SE0100-1A■22-5■A7	2T2A-07600-022

SINAMICS G180

SINAMICS G180 compact units and SINAMICS G180 cabinet systems

SINAMICS G180 compact units

Dimensional drawings (continued)

Frame size K4

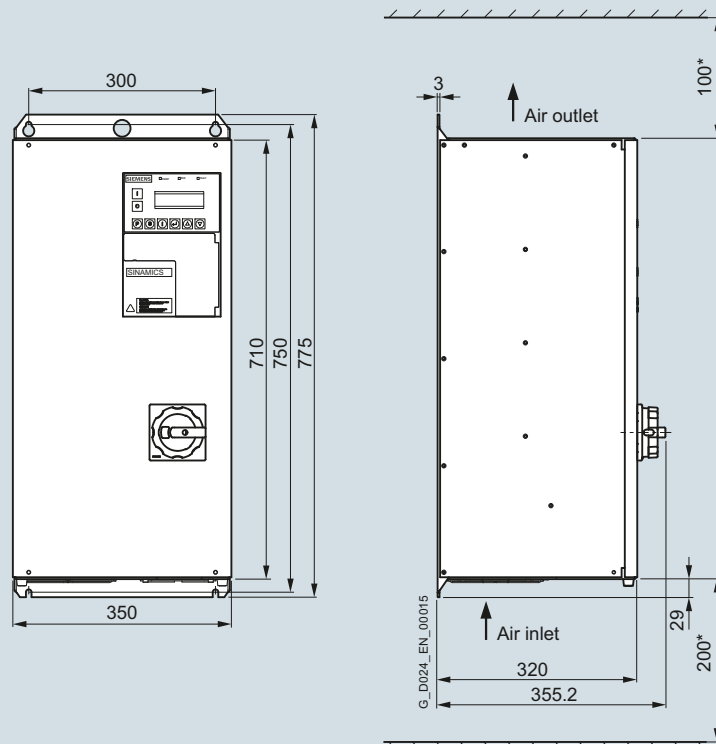

* Minimum clearance for air inlet and air outlet

Main switch is integrated in the compact unit only with option **S41**.

SINAMICS G180 compact units	Converter type
6SE0100-1AC27-8■A7	2T2A-07400-037
6SE0100-1AC28-8■A7	2T2A-07400-045
6SE0100-1AC31-1■A7	2T2A-07400-055
6SE0100-1AD27-8■A7	2T2A-07500-045
6SE0100-1AD28-8■A7	2T2A-07500-055
6SE0100-1AD31-1■A7	2T2A-07500-075
6SE0100-1A■23-4■A7	2T2A-07600-030
6SE0100-1A■28-0■A7	2T2A-07600-075

SINAMICS G180

SINAMICS G180 compact units and SINAMICS G180 cabinet systems

SINAMICS G180 compact units

Dimensional drawings (continued)

Frame size K5

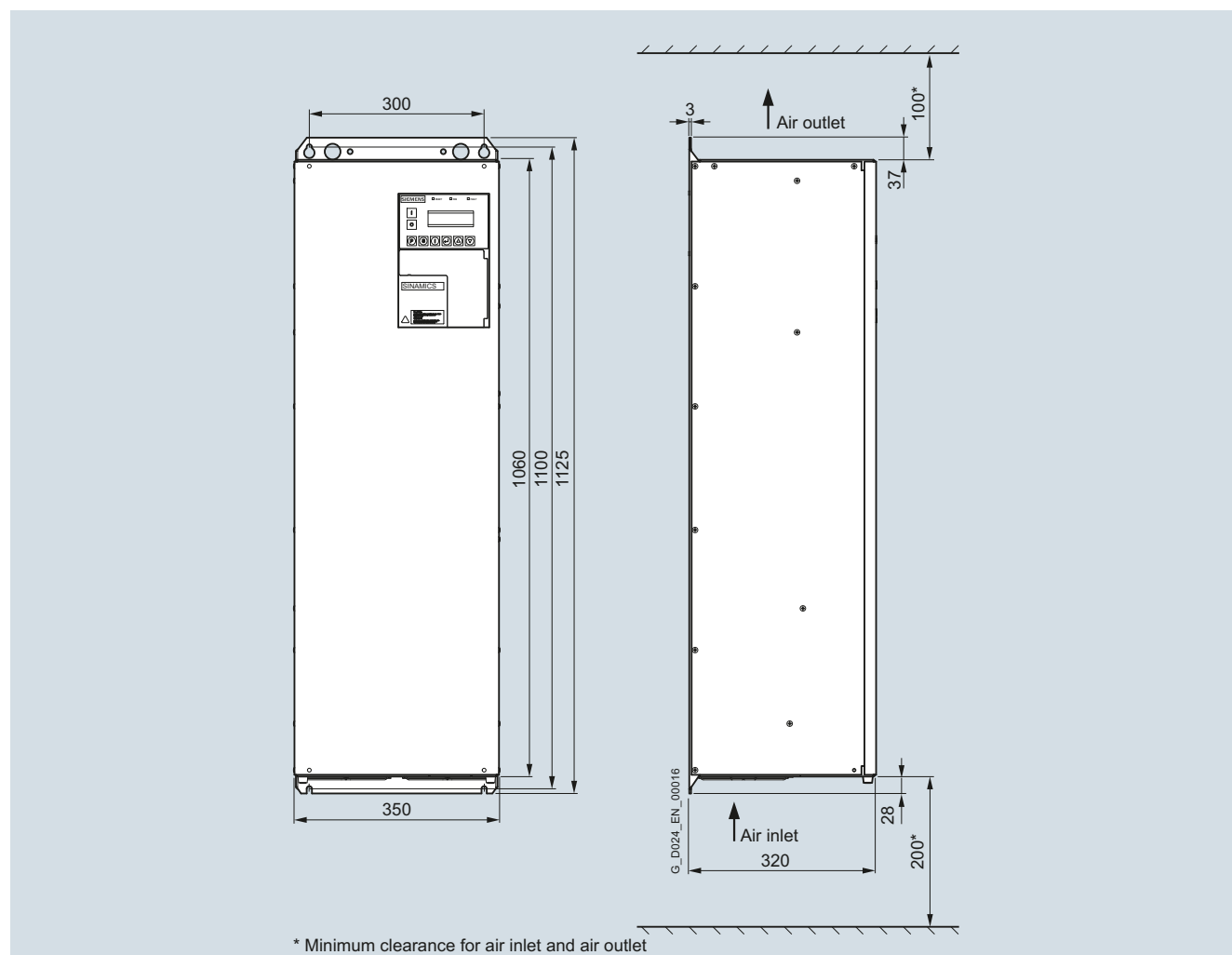

SINAMICS G180 compact units	Converter type
6SE0100-1AC31-5■A7	2T2A-07400-075
6SE0100-1AC31-8■A7	2T2A-07400-090
6SE0100-1AC32-1■A7	2T2A-07400-110
6SE0100-1AD31-5■A7	2T2A-07500-090
6SE0100-1AD31-8■A7	2T2A-07500-110
6SE0100-1AD32-1■A7	2T2A-07500-132
6SE0100-1A■31-0■A7	2T2A-07600-090
6SE0100-1A■31-2■A7	2T2A-07600-110
6SE0100-1A■31-4■A7	2T2A-07600-132

SINAMICS G180

SINAMICS G180 compact units and SINAMICS G180 cabinet systems

SINAMICS G180 compact units

Dimensional drawings (continued)

Frame size K51

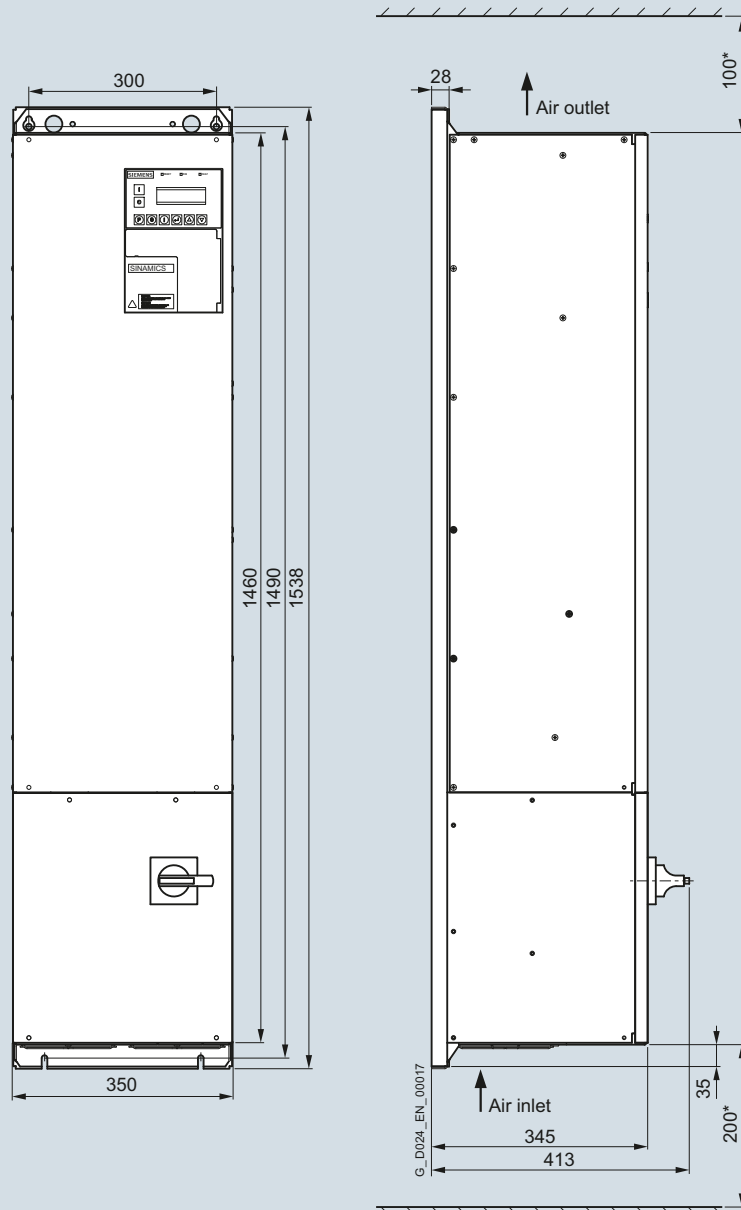

* Minimum clearance for air inlet and air outlet

Main switch is integrated as standard in compact units of frame size K51

SINAMICS G180 compact units	Converter type
6SE0100-1AC31-5■A7 +S41	2T2A-07400-075
6SE0100-1AC31-8■A7 +S41	2T2A-07400-090
6SE0100-1AC32-1■A7 +S41	2T2A-07400-110
6SE0100-1AD31-5■A7 +S41	2T2A-07500-090
6SE0100-1AD31-8■A7 +S41	2T2A-07500-110
6SE0100-1AD32-1■A7 +S41	2T2A-07500-132
6SE0100-1A■31-0■A7 +S41	2T2A-07600-090
6SE0100-1A■31-2■A7 +S41	2T2A-07600-110
6SE0100-1A■31-4■A7 +S41	2T2A-07600-132

SINAMICS G180

SINAMICS G180 compact units and SINAMICS G180 cabinet systems

SINAMICS G180 compact units

Dimensional drawings (continued)

Frame size K6

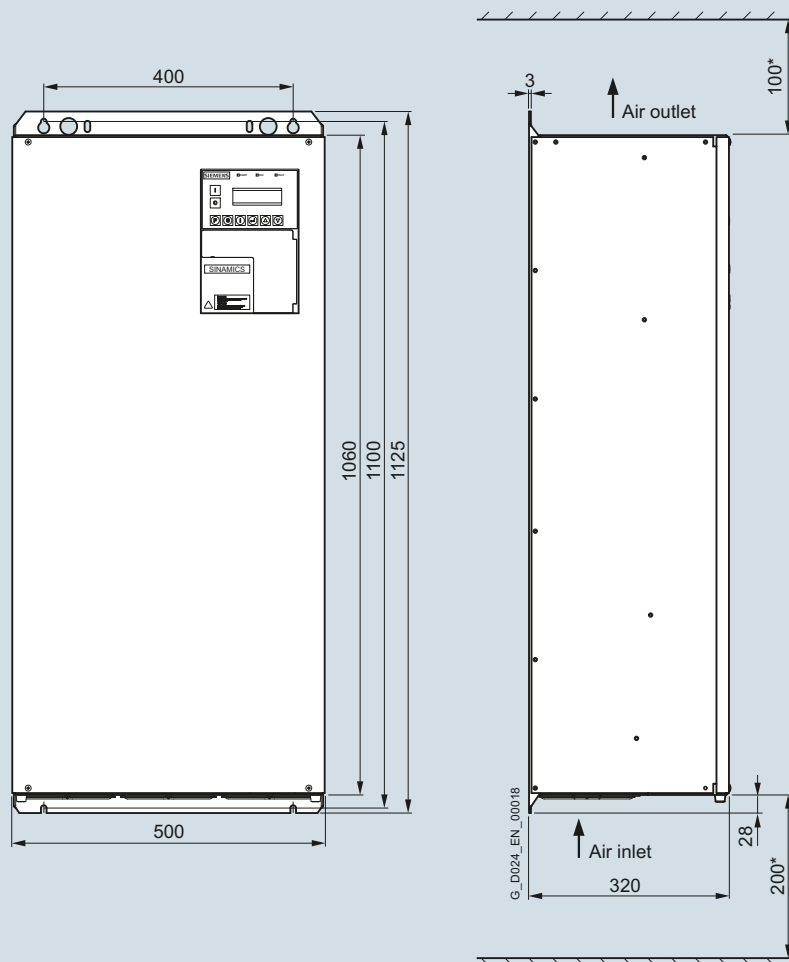

* Minimum clearance for air inlet and air outlet

SINAMICS G180 compact units	Converter type
6SE0100-1AC32-5■A7	2T2A-07400-132
6SE0100-1AC33-0■A7	2T2A-07400-160
6SE0100-1AD32-5■A7	2T2A-07500-160
6SE0100-1AD33-0■A7	2T2A-07500-200
6SE0100-1A■31-7■A7	2T2A-07600-160
6SE0100-1A■32-1■A7	2T2A-07600-200

SINAMICS G180

SINAMICS G180 compact units and SINAMICS G180 cabinet systems

SINAMICS G180 cabinet systems

Overview

SINAMICS G180 cabinet systems comprise SINAMICS G180 compact units which are combined with Rittal TS8 cabinets and customer-specific control accessories to create individual cabinet systems.

Global use

SINAMICS G180 converter cabinet systems are manufactured in compliance with relevant international standards and regulations, and are therefore suitable for global use (see technical data).



SINAMICS G180 – cabinet system with four compact units

Design

- Modular principle permits the design of cost-optimized, customized systems
- A complete installation can be quickly and easily assembled through the integration of various industry-specific control packages
- Use of CAE/CAM systems increases flexibility and shortens delivery times
- Capable of integration in any control concept thanks to customized design
- Capable of adaptation to numerous bus systems
- Overall concept is devised to minimize space requirements
- Rittal TS8 cabinet system ensures acceptance anywhere in the world
- Optimum use of space thanks to different cabinet sizes
- Easy to adapt to an extensive range of climatic conditions
- Quick access to all components from front of cabinet eases maintenance
- Additional fans are not generally required
- Cable entry from below incl. cable clamping bar, shielding bus and grounding bar

Number of compact units in cabinet system (depending on width)

Compact units	Cabinet system width			
	600 mm	800 mm	1000 mm	1200 mm
165 mm wide 2.2 ... 11 kW (400 V) 2.2 ... 15 kW (500 V)	3	4	5	6
225 mm wide 15 ... 30 kW (400 V) 22 ... 37 kW (500 V) 7.5 ... 22 kW (690 V)	2	3	4	4
350 mm wide 37 ... 110 kW (400 V) 45 ... 132 kW (500 V) 30 ... 132 kW (690 V)	1	2	2	3
500 mm wide 132 ... 160 kW (400 V) 160 ... 200 kW (500 V) 160 ... 200 kW (690 V)	1	1	1	2

This overview applies to cabinet systems without an additional control system (except for option S31). We would be happy to assist with optimization of the cabinet system width.

Selection and ordering data

400 V, 6-pulse

SINAMICS G180 compact unit in control cabinet (230 to 500 V 3 AC TN/TT system, 50 to 60 Hz)

Converter type	Connected load kVA	Output		Type rating ²⁾ kW	SINAMICS G180 cabinet systems	Version (for option selection)
		Continuous current A	Short-time current ¹⁾ A		Article No.	
2X3A-8740 ■ -002	3.7	5.5	6.5	2.2	6SE0140-1 ■ C15-5 ■ A7	A
2X3A-8740 ■ -003	4.6	7	8	3	6SE0140-1 ■ C17-0 ■ A7	A
2X3A-8740 ■ -004	6.4	9.5	11	4	6SE0140-1 ■ C21-0 ■ A7	A
2X3A-8740 ■ -005	8.6	13	15	5.5	6SE0140-1 ■ C21-3 ■ A7	A
2X3A-8740 ■ -007	12.1	18	20	7.5	6SE0140-1 ■ C21-8 ■ A7	A
2X3A-8740 ■ -011	16	24.5	27	11	6SE0140-1 ■ C22-5 ■ A7	A
2X3A-8740 ■ -015	24.4	37	44	15	6SE0140-1 ■ C23-7 ■ A7	B
2X3A-8740 ■ -022	32	48	54	22	6SE0140-1 ■ C24-8 ■ A7	C
2X3A-8740 ■ -030	39.2	58	63	30	6SE0140-1 ■ C25-8 ■ A7	C
2X3A-8740 ■ -037	52.3	78	88	37	6SE0140-1 ■ C27-8 ■ A7	D
2X3A-8740 ■ -045	57.5	88	110	45	6SE0140-1 ■ C28-8 ■ A7	D
2X3A-8740 ■ -055	74.8	110	126	55	6SE0140-1 ■ C31-1 ■ A7	D
2X3A-8740 ■ -075	98.4	145	165	75	6SE0140-1 ■ C31-5 ■ A7	E
2X3A-8740 ■ -090	119	175	204	90	6SE0140-1 ■ C31-8 ■ A7	E
2X3A-8740 ■ -110	136	205	240	110	6SE0140-1 ■ C32-1 ■ A7	E
2X3A-8740 ■ -132	161	245	300	132	6SE0140-1 ■ C32-5 ■ A7	F
2X3A-8740 ■ -160	197	295	360	160	6SE0140-1 ■ C33-0 ■ A7	F

See number code for converter type and article number code on Page 2/31

500 V, 6-pulse

SINAMICS G180 compact unit in control cabinet (230 to 500 V 3 AC IT system, 50 to 60 Hz)

Converter type	Connected load kVA	Output		Type rating ²⁾ kW	SINAMICS G180 cabinet systems	Version (for option selection)
		Continuous current A	Short-time current ¹⁾ A		Article No.	
2X3A-8750 ■ -002	3.8	4.5	5	2.2	6SE0140-1 ■ D14-5 ■ A7	G
2X3A-8750 ■ -003	4.5	5.5	6.5	3	6SE0140-1 ■ D15-5 ■ A7	G
2X3A-8750 ■ -004	5.8	7	8	4	6SE0140-1 ■ D17-0 ■ A7	G
2X3A-8750 ■ -005	8.2	9.5	11	5.5	6SE0140-1 ■ D21-0 ■ A7	G
2X3A-8750 ■ -007	10.9	13	15	7.5	6SE0140-1 ■ D21-3 ■ A7	G
2X3A-8750 ■ -011	15.2	18	20	11	6SE0140-1 ■ D21-8 ■ A7	G
2X3A-8750 ■ -015	20.4	24.5	27	15	6SE0140-1 ■ D22-5 ■ A7	G
2X3A-8750 ■ -022	31.3	37	44	22	6SE0140-1 ■ D23-7 ■ A7	H
2X3A-8750 ■ -030	40.5	48	54	30	6SE0140-1 ■ D24-8 ■ A7	I
2X3A-8750 ■ -037	49.6	58	63	37	6SE0140-1 ■ D25-8 ■ A7	I
2X3A-8750 ■ -045	64.2	78	88	45	6SE0140-1 ■ D27-8 ■ A7	J
2X3A-8750 ■ -055	76.1	88	110	55	6SE0140-1 ■ D28-8 ■ A7	J
2X3A-8750 ■ -075	94.4	110	126	75	6SE0140-1 ■ D31-1 ■ A7	J
2X3A-8750 ■ -090	124	145	165	90	6SE0140-1 ■ D31-5 ■ A7	K
2X3A-8750 ■ -110	147	175	204	110	6SE0140-1 ■ D31-8 ■ A7	K
2X3A-8750 ■ -132	171	205	240	132	6SE0140-1 ■ D32-1 ■ A7	K
2X3A-8750 ■ -160	206	245	300	160	6SE0140-1 ■ D32-5 ■ A7	L
2X3A-8750 ■ -200	248	295	360	200	6SE0140-1 ■ D33-0 ■ A7	L

See number code for converter type and article number code on Page 2/31

1) Short-time current for 60 s every 10 minutes.

2) Rated power of a typical 2- to 6-pole standard motor.

SINAMICS G180

SINAMICS G180 compact units and SINAMICS G180 cabinet systems

SINAMICS G180 cabinet systems

Selection and ordering data (continued)

690 V, 6-pulse

SINAMICS G180 compact unit in control cabinet (230 to 600/690 V 3 AC TN/TT system, 50 to 60 Hz)¹⁾

Converter type	Connected load kVA	Output			SINAMICS G180 cabinet systems Article No.	Version (for option selection)
		Continuous current A	Short-time current ²⁾ A	Type rating ³⁾ kW		
2X3A-8769 ■ -007	10.8	9.5	11	7.5	6SE0140-1 ■ G21-0 ■ A7	M
2X3A-8769 ■ -011	14.3	13	16	11	6SE0140-1 ■ G21-3 ■ A7	M
2X3A-8769 ■ -015	20.3	18	21	15	6SE0140-1 ■ G21-8 ■ A7	N
2X3A-8769 ■ -022	30.5	27	33	22	6SE0140-1 ■ G22-5 ■ A7	N
2X3A-8769 ■ -030	45.5	36	45	30	6SE0140-1 ■ G23-4 ■ A7	O
2X3A-8769 ■ -037	52.6	43	55	37	6SE0140-1 ■ G24-2 ■ A7	O
2X3A-8769 ■ -045	60.9	50	65	45	6SE0140-1 ■ G25-0 ■ A7	O
2X3A-8769 ■ -055	74	60	75	55	6SE0140-1 ■ G25-8 ■ A7	O
2X3A-8769 ■ -075	97.9	80	90	75	6SE0140-1 ■ G28-0 ■ A7	O
2X3A-8769 ■ -090	123	95	120	90	6SE0140-1 ■ G31-0 ■ A7	P
2X3A-8769 ■ -110	143	120	140	110	6SE0140-1 ■ G31-2 ■ A7	P
2X3A-8769 ■ -132	184	150	175	132	6SE0140-1 ■ G31-4 ■ A7	P
2X3A-8769 ■ -160	216	175	210	160	6SE0140-1 ■ G31-7 ■ A7	Q
2X3A-8769 ■ -200	266	210	255	200	6SE0140-1 ■ G32-1 ■ A7	Q

See number code for converter type and article number code on Page 2/31

SINAMICS G180 compact unit in control cabinet (230 to 600/690 V 3 AC IT system, 50 to 60 Hz)¹⁾

Converter type	Connected load kVA	Output			SINAMICS G180 cabinet systems Article No.	Version (for option selection)
		Continuous current A	Short-time current ²⁾ A	Type rating ³⁾ kW		
2X3A-8769 ■ -007	10.8	9.5	11	7.5	6SE0140-1 ■ H21-0 ■ A7	R
2X3A-8769 ■ -011	14.3	13	16	11	6SE0140-1 ■ H21-3 ■ A7	R
2X3A-8769 ■ -015	20.3	18	21	15	6SE0140-1 ■ H21-8 ■ A7	S
2X3A-8769 ■ -022	30.5	27	33	22	6SE0140-1 ■ H22-5 ■ A7	S
2X3A-8769 ■ -030	45.5	36	45	30	6SE0140-1 ■ H23-4 ■ A7	T
2X3A-8769 ■ -037	52.6	43	55	37	6SE0140-1 ■ H24-2 ■ A7	T
2X3A-8769 ■ -045	60.9	50	65	45	6SE0140-1 ■ H25-0 ■ A7	T
2X3A-8769 ■ -055	74	60	75	55	6SE0140-1 ■ H25-8 ■ A7	T
2X3A-8769 ■ -075	97.9	80	90	75	6SE0140-1 ■ H28-0 ■ A7	T
2X3A-8769 ■ -090	123	95	120	90	6SE0140-1 ■ H31-0 ■ A7	U
2X3A-8769 ■ -110	143	120	140	110	6SE0140-1 ■ H31-2 ■ A7	U
2X3A-8769 ■ -132	184	150	175	132	6SE0140-1 ■ H31-4 ■ A7	U
2X3A-8769 ■ -160	216	175	210	160	6SE0140-1 ■ H31-7 ■ A7	V
2X3A-8769 ■ -200	266	210	255	200	6SE0140-1 ■ H32-1 ■ A7	V

See number code for converter type and article number code on Page 2/31

¹⁾ With an NRTL unit ("U" in 14th position of article number), the voltage range ends at maximum 600 V, otherwise at 690 V.

²⁾ Short-time current for 60 s every 10 minutes.

³⁾ Rated power of a typical 2- to 6-pole standard motor.

SINAMICS G180

SINAMICS G180 compact units and SINAMICS G180 cabinet systems

SINAMICS G180 cabinet systems

Selection and ordering data (continued)

Article number code

Position of Article No.	1	2	3	4	5	6	7	8	9	10	11	12	13	14	15	16			
SINAMICS G180 cabinet system	6	S	E	0	1	.	0	-	.	■	.	.	.	-	.	■	A	.	
Mechanical design																			
Cabinet with compact units						4													
Line harmonics																			
6-pulse								1											
Number of parallel connected systems																			
Cabinet with one compact unit										K									
Cabinet with two compact units ¹⁾										L									
Cabinet with 3 identical compact units ¹⁾										M									
Cabinet with 4 identical compact units ¹⁾										N									
Cabinet with 5 identical compact units ¹⁾										P									
Cabinet with 6 identical compact units ¹⁾										Q									
Cabinet with various compact units ¹⁾²⁾										Y									
Supply voltage																			
230 ... 500 V 3 AC TN/TT, 50 ... 60 Hz																	C		
230 ... 500 V 3 AC IT, 50 ... 60 Hz																	D		
230 ... 600/690 V 3 AC ³⁾ TN/TT, 50 ... 60 Hz																	G		
230 ... 600/690 V 3 AC ³⁾ IT, 50 ... 60 Hz																	H		
Option module																			
IEC, EN																		A	
NRTL-certified according to UL 508C ³⁾ (by TÜV and/or UL)																		U	
Version/release number																			
Version/release number T7																			7

Number code for converter type

Position of <i>converter type</i> No.	1	2	3	4	5	6	7	8	9	10	11	12		
SINAMICS G180 cabinet system	2	X	.	.	-	■	-	.	.	.
Degree of protection														
IP21			3											
IP54			6											
IP55			7											
Different degree of protection (e.g. IP43)			9											
Number of pulses in the input and output														
6-pulse input and output				A										
Mechanical design														
Cabinet system with air cooling					8									
Modification status														
Modification status 7						7								
Line voltage														
400 V unit							4	0						
500 V unit							5	0						
690 V unit							6	9						
Number of integrated converters														
Number of converters									.					
Achievable type rating in kW with continuous output current														
If the 10th position of the article number is "9", the other two digits show the type rating in kW × 100.										.	.	.		

¹⁾ Not yet available, on request.

²⁾ When ordering, please state the number of compact units in the control cabinet and their individual ratings.

³⁾ With an NRTL unit ("U" in 14th position of article number), the voltage range ends at maximum 600 V, otherwise at 690 V.

SINAMICS G180

SINAMICS G180 compact units and SINAMICS G180 cabinet systems

SINAMICS G180 cabinet systems

Options

The following tables provide an overview of the options and their availability for SINAMICS G180 compact units in control cabinets (cabinet systems) with a supply voltage of 400 V, 500 V or 690 V. (For details, see catalog chapter 4 "Option descriptions".)

Option text	Additional ordering data -Z with order code and, if necessary, with plain text specification	SINAMICS G180 cabinet systems (compact units installed in a control cabinet)											
		400 V TN/TT system						500 V IT system					
Version – see selection and ordering data													
		A	B	C	D	E	F	G	H	I	J	K	L
Converter cabinet width													
406 mm	H80	✓	✓	✓	–	–	–	✓	✓	✓	–	–	–
606 mm	H81	□	□	□	□	□	□	□	□	□	□	□	□
806 mm	H82	✓	✓	✓	✓	✓	✓	✓	✓	✓	✓	✓	✓
1006 mm	H83	✓	✓	✓	✓	✓	✓	✓	✓	✓	✓	✓	✓
1206 mm	H84	✓	✓	✓	✓	✓	✓	✓	✓	✓	✓	✓	✓
1406 mm	H85	✓	✓	✓	✓	✓	✓	✓	✓	✓	✓	✓	✓
1606 mm	H86	✓	✓	✓	✓	✓	✓	✓	✓	✓	✓	✓	✓
Additional cabinet													
400 mm	H90	✓	✓	✓	✓	✓	✓	✓	✓	✓	✓	✓	✓
600 mm	H91	✓	✓	✓	✓	✓	✓	✓	✓	✓	✓	✓	✓
800 mm	H92	✓	✓	✓	✓	✓	✓	✓	✓	✓	✓	✓	✓
1000 mm	H93	✓	✓	✓	✓	✓	✓	✓	✓	✓	✓	✓	✓
1200 mm	H94	✓	✓	✓	✓	✓	✓	✓	✓	✓	✓	✓	✓
Line voltages													
Line voltage 380 V, 50 Hz	V70	✓	✓	✓	✓	✓	✓	✓	✓	✓	✓	✓	✓
Line voltage 400 V, 50 Hz	V71	✓	✓	✓	✓	✓	✓	✓	✓	✓	✓	✓	✓
Line voltage 415 V, 50 Hz	V72	✓	✓	✓	✓	✓	✓	✓	✓	✓	✓	✓	✓
Line voltage 500 V, 50 Hz	V73	✓	✓	✓	✓	✓	✓	✓	✓	✓	✓	✓	✓
Line voltage 660 V, 50 Hz	V74	–	–	–	–	–	–	–	–	–	–	–	–
Line voltage 690 V, 50 Hz	V75	–	–	–	–	–	–	–	–	–	–	–	–
Line voltage 440 V, 60 Hz	V76	✓	✓	✓	✓	✓	✓	✓	✓	✓	✓	✓	✓
Line voltage 460 V, 60 Hz	V77	✓	✓	✓	✓	✓	✓	✓	✓	✓	✓	✓	✓
Line voltage 480 V, 60 Hz	V78	✓	✓	✓	✓	✓	✓	✓	✓	✓	✓	✓	✓
Line voltage 600 V, 60 Hz	V79	–	–	–	–	–	–	–	–	–	–	–	–
Line voltage 660 V, 60 Hz	V80	–	–	–	–	–	–	–	–	–	–	–	–
Special line voltage; please specify voltage	Y70 • and identification code	✓ ¹⁾	✓ ¹⁾	✓ ¹⁾	✓ ¹⁾	✓ ¹⁾	✓ ¹⁾	✓ ¹⁾	✓ ¹⁾	✓ ¹⁾	✓ ¹⁾	✓ ¹⁾	✓ ¹⁾
External auxiliary power supply													
Connection for 230 V 1 AC 50 Hz auxiliary voltage provided by customer	C36	✓	✓	✓	✓	✓	✓	✓	✓	✓	✓	✓	✓
Connection for 400 V 3 AC 50 Hz auxiliary voltage provided by customer	C38	✓	✓	✓	✓	✓	✓	✓	✓	✓	✓	✓	✓
Connection for 500 V 3 AC 50 Hz auxiliary voltage provided by customer	C43	✓	✓	✓	✓	✓	✓	✓	✓	✓	✓	✓	✓
Connection for 690 V 3 AC 50 Hz auxiliary voltage provided by customer	C48	✓	✓	✓	✓	✓	✓	✓	✓	✓	✓	✓	✓
Connection for other 3 AC voltage provided by customer; please specify voltage	Y36 • and identification code	✓	✓	✓	✓	✓	✓	✓	✓	✓	✓	✓	✓
External control voltage supply													
Connection for 230 V 1 AC 50 Hz control voltage provided by customer, without UPS backup	C56	✓	✓	✓	✓	✓	✓	✓	✓	✓	✓	✓	✓
Connection for 230 V 1 AC 50 Hz control voltage provided by customer, with UPS backup	C57	✓	✓	✓	✓	✓	✓	✓	✓	✓	✓	✓	✓
Connection for different 1 AC control voltage (47 to 63 Hz) provided by customer; please specify voltage	Y55 • and identification code	✓	✓	✓	✓	✓	✓	✓	✓	✓	✓	✓	✓
RFI suppression filter													
RFI suppression filter, category C2 or C3 (class A)	L00	□	□	□	□	□	□	–	–	–	–	–	–
RFI suppression filter, category C1 (class B)	L02	✓	✓	✓	✓	✓	✓	–	–	–	–	–	–

For legends and footnotes, see Page 2/38.

Options (continued)

Option text	Additional ordering data -Z with order code and, if necessary, with plain text specification	SINAMICS G180 cabinet systems (compact units installed in a control cabinet)											
		400 V TN/TT system						500 V IT system					
Version – see selection and ordering data													
		A	B	C	D	E	F	G	H	I	J	K	L
Line Harmonics Filter													
Line Harmonics Filter for 50 Hz line frequency up to 500 V	L03	H81 ⁽³⁾	H81 ⁽³⁾	H82 ⁽³⁾	H82 ⁽³⁾	H81 ⁽³⁾ + H91 ⁽³⁾	H81 ⁽³⁾ + H91 ⁽³⁾	H81 ⁽³⁾	H81 ⁽³⁾	H82 ⁽³⁾	H82 ⁽³⁾	H81 ⁽³⁾ + H91 ⁽³⁾	H81 ⁽³⁾ + H91 ⁽³⁾
Line Harmonics Filter for 60 Hz line frequency up to 480 V	L04	H81 ⁽³⁾	H81 ⁽³⁾	H82 ⁽³⁾	H82 ⁽³⁾	H81 ⁽³⁾ + H91 ⁽³⁾	H81 ⁽³⁾ + H91 ⁽³⁾	H81 ⁽³⁾	H81 ⁽³⁾	H82 ⁽³⁾	H82 ⁽³⁾	H81 ⁽³⁾ + H91 ⁽³⁾	H81 ⁽³⁾ + H91 ⁽³⁾
Output filter													
Strengthened dv/dt output filter for max. 250/300 m (type-dependent). Design for longer motor cables available on request	L10	✓	✓	✓	✓	✓	✓	□	□	□	□	□	□
Sine-wave filter integrated in control cabinet, suitable for motor frequencies of ≤ 75 Hz, voltage drop of approximately 5 % of line voltage	L17	✓	✓	✓	✓	✓	H81 ⁽³⁾ + H91 ⁽³⁾	✓	✓	✓	✓	✓	H81 ⁽³⁾ + H91 ⁽³⁾
Standard accessories packages													
Peripheral board 4 (G05) instead of peripheral board 2 (G03) (only in conjunction with package S01, S02, S03, S04, S08, S09, S11, S12)	G08	✓	✓	✓	✓	✓	✓	✓	✓	✓	✓	✓	✓
Accessories package S01 with main switch, line contactor, EMERGENCY OFF pushbutton and safety relay, board G03, local/remote switch	S01	✓	✓	✓	✓	✓	✓	✓	✓	✓	✓	✓	✓
Accessories package S02 with circuit breaker, line contactor, EMERGENCY OFF pushbutton and safety relay, board G03, local/remote switch	S02	✓	✓	✓	✓	✓	✓	✓	✓	✓	✓	✓	✓
Accessories package with main switch, line contactor, board G03, local/remote switch	S03	✓	✓	✓	✓	✓	✓	✓	✓	✓	✓	✓	✓
Accessories package with circuit breaker, line contactor, board G03, local/remote switch	S04	✓	✓	✓	✓	✓	✓	✓	✓	✓	✓	✓	✓
Accessories package with main switch, line contactor, Calomat, RCU box connection	S06	✓	✓	✓	✓	✓	✓	✓	✓	✓	✓	✓	✓
Bypass for smooth line synchronization (soft start function) incl. line-side main switch and contactors at the converter output and in bypass	S08	✓	✓	✓	✓	H82 ⁽³⁾	H83 ⁽³⁾	✓	✓	✓	✓	H82 ⁽³⁾	H83 ⁽³⁾
Bypass for smooth line synchronization (soft start function) incl. line-side circuit breaker and contactors at the converter output and in bypass	S09	✓	✓	✓	✓	H82 ⁽³⁾	H83 ⁽³⁾	✓	✓	✓	✓	H82 ⁽³⁾	H83 ⁽³⁾
Accessories package S11 with line-side main switch, board G03, local/remote switch	S11	✓	✓	✓	✓	✓	✓	✓	✓	✓	✓	✓	✓
Accessories package S12 with line-side circuit breaker, board G03, local/remote switch	S12	✓	✓	✓	✓	✓	✓	✓	✓	✓	✓	✓	✓
Bypass with line-side main switch, contactors at converter output and in bypass, switchover between manual and automatic, local/remote switch	S21	✓	✓	✓	✓	H82 ⁽³⁾	H83 ⁽³⁾	✓	✓	✓	✓	H82 ⁽³⁾	H83 ⁽³⁾
Bypass with line-side circuit breaker, contactors at converter output and in bypass, switchover between manual and automatic, local/remote switch	S22	✓	✓	✓	✓	H82 ⁽³⁾	H83 ⁽³⁾	✓	✓	✓	✓	H82 ⁽³⁾	H83 ⁽³⁾
Bypass with line-side main switch, contactors at converter output and in bypass, EMERGENCY OFF safety relay, switchover between manual and automatic, local/remote switch	S23	✓	✓	✓	✓	H82 ⁽³⁾	H83 ⁽³⁾	✓	✓	✓	✓	H82 ⁽³⁾	H83 ⁽³⁾
Bypass with line-side circuit breaker, contactors at converter output and in bypass, EMERGENCY OFF safety relay, switchover between manual and automatic, local/remote switch	S24	✓	✓	✓	✓	H82 ⁽³⁾	H83 ⁽³⁾	✓	✓	✓	✓	H82 ⁽³⁾	H83 ⁽³⁾

For legends and footnotes, see Page 2/38.

SINAMICS G180

SINAMICS G180 compact units and SINAMICS G180 cabinet systems

SINAMICS G180 cabinet systems

Options (continued)

Option text	Additional ordering data -Z with order code and, if necessary, with plain text specification	SINAMICS G180 cabinet systems (compact units installed in a control cabinet)											
		400 V TN/TT system						500 V IT system					
Version – see selection and ordering data													
		A	B	C	D	E	F	G	H	I	J	K	L
Standard accessories packages (continued)													
NAMUR accessories package with Test/Normal operation switch, option G05, terminal strip compliant with NAMUR NE37 (without main switch)	S31	✓	✓	✓	✓	✓	✓	✓	✓	✓	✓	✓	✓
NAMUR accessories package with Test/Normal operation switch, main switch, line contactor, option G05, terminal strip compliant with NAMUR NE37	S32	✓	✓	✓	✓	✓	✓	✓	✓	✓	✓	✓	✓
Braking chopper													
Braking chopper integrated into converter (braking resistor is not included and must be ordered separately)	L72	□	✓	✓	✓	✓	✓	□	✓	✓	✓	✓	✓
CALOMAT CK145													
CALOMAT CK145 without storage for motor temperature prewarning	L80	✓	✓	✓	✓	✓	✓	✓	✓	✓	✓	✓	✓
CALOMAT CK145 with storage for motor temperature trip	L81	✓	✓	✓	✓	✓	✓	✓	✓	✓	✓	✓	✓
CALOMAT CK145 without storage for transformer temperature prewarning	L82	✓	✓	✓	✓	✓	✓	✓	✓	✓	✓	✓	✓
CALOMAT CK145 with storage for transformer temperature trip	L83	✓	✓	✓	✓	✓	✓	✓	✓	✓	✓	✓	✓
CALOMAT CK145 for other PTC thermistor monitoring functions	Y80 • and identification code	✓	✓	✓	✓	✓	✓	✓	✓	✓	✓	✓	✓
Pt100 evaluation unit													
Pt100 evaluation unit for motor winding temperature, integrated in control cabinet for monitoring of 3 × Pt100 or 3 × KTY83/84 sensors	L90	✓	✓	✓	✓	✓	✓	✓	✓	✓	✓	✓	✓
Pt100 evaluation unit for motor bearing temperature, integrated in control cabinet for monitoring of 2 × Pt100 or 2 × KTY83/84 sensors	L91	✓	✓	✓	✓	✓	✓	✓	✓	✓	✓	✓	✓
Pt100 evaluation unit for motor winding temperature, integrated in cabinet for monitoring 3 × Pt100 sensors; plus an analog output 0 to 10 V or 0(4) to 20 mA connected to terminals for the hottest winding temperature	L92	✓	✓	✓	✓	✓	✓	✓	✓	✓	✓	✓	✓
Pt100 evaluation unit for motor bearing temperature, integrated in cabinet for monitoring 2 × Pt100 sensors or 2 × KTY83/84 sensors; plus two analog outputs 0 to 10 V or 0(4) to 20 mA connected to terminals for bearing temperature	L93	✓	✓	✓	✓	✓	✓	✓	✓	✓	✓	✓	✓
Pt100 evaluation unit for motor winding and bearing temperatures, integrated in cabinet for monitoring 6 × Pt100 sensors; plus two analog outputs 0 to 10 V or 0(4) to 20 mA connected to terminals for the hottest winding and bearing temperatures	L94	✓	✓	✓	✓	✓	✓	✓	✓	✓	✓	✓	✓
Pt100 evaluation unit for other temperature monitoring functions, integrated in cabinet for monitoring of 3 × Pt100 or 3 × KTY83/84 sensors	Y90 • and identification code	✓	✓	✓	✓	✓	✓	✓	✓	✓	✓	✓	✓
Pt100 evaluation unit for other temperature monitoring functions, integrated in cabinet for monitoring 6 × Pt100 sensors; plus two analog outputs 0 to 10 V or 0(4) to 20 mA connected to terminals	Y94 • and identification code	✓	✓	✓	✓	✓	✓	✓	✓	✓	✓	✓	✓
Degrees of protection													
Increased degree of protection IP41 for air-cooled cabinet units and systems	M41	✓	✓	✓	✓	✓	✓	✓	✓	✓	✓	✓	✓
Increased degree of protection IP43 for air-cooled cabinet units and systems	M43	✓	✓	✓	✓	✓	✓	✓	✓	✓	✓	✓	✓

For legends and footnotes, see Page 2/38.

SINAMICS G180

SINAMICS G180 compact units and SINAMICS G180 cabinet systems

SINAMICS G180 cabinet systems

Options (continued)

Option text	Additional ordering data -Z with order code and, if necessary, with plain text specification	SINAMICS G180 cabinet systems (compact units installed in a control cabinet)											
		400 V TN/TT system						500 V IT system					
Version – see selection and ordering data													
		A	B	C	D	E	F	G	H	I	J	K	L
Degrees of protection (continued)													
Increased degree of protection IP54 for air-cooled cabinet units and systems; not suitable for outdoor applications	M54	✓	✓	✓	✓	✓	✓	✓	✓	✓	✓	✓	✓
Air flange for connection to customer's exhaust air systems (air outlet IP00)	M63	✓	✓	✓	✓	✓	✓	✓	✓	✓	✓	✓	✓
Cabinet options													
Control cabinet base, welded and suitable for use with transport rollers, in RAL 7035, h = 200 mm	M05	✓	✓	✓	✓	✓	✓	✓	✓	✓	✓	✓	✓
Control cabinet base, standard version in RAL 7022/9005, h = 100 mm	M06	✓	✓	✓	✓	✓	✓	✓	✓	✓	✓	✓	✓
Control cabinet base, standard version in RAL 7022/9005, h = 200 mm	M07	✓	✓	✓	✓	✓	✓	✓	✓	✓	✓	✓	✓
Cable entry from the top: Power cable	M13	✓ ²⁾	✓ ²⁾	✓ ²⁾	✓ ²⁾	✓ ²⁾	✓ ²⁾	✓ ²⁾	✓ ²⁾	✓ ²⁾	✓ ²⁾	✓ ²⁾	✓ ²⁾
Door opening angle 180°	M17	✓	✓	✓	✓	✓	✓	✓	✓	✓	✓	✓	✓
Window in door for viewing internal display	M19	✓	✓	✓	✓	✓	✓	✓	✓	✓	✓	✓	✓
Partitions between compact units for cabinet systems	M24	✓	✓	✓	✓	✓	✓	✓	✓	✓	✓	✓	✓
Door hinge on left	M28	✓	✓	✓	✓	✓	✓	✓	✓	✓	✓	✓	✓
Cable entry from the top: Control cables	M34	✓ ²⁾	✓ ²⁾	✓ ²⁾	✓ ²⁾	✓ ²⁾	✓ ²⁾	✓ ²⁾	✓ ²⁾	✓ ²⁾	✓ ²⁾	✓ ²⁾	✓ ²⁾
Comfort-grip handle with double-bit key lock	M38	✓	✓	✓	✓	✓	✓	✓	✓	✓	✓	✓	✓
Comfort-grip handle with integrated pushbutton	M39	✓	✓	✓	✓	✓	✓	✓	✓	✓	✓	✓	✓
Comfort-grip handle with cylinder lock	M40	✓	✓	✓	✓	✓	✓	✓	✓	✓	✓	✓	✓
Air supply via cable floor. No filter mats required in door	M59	✓	✓	✓	✓	✓	✓	✓	✓	✓	✓	✓	✓
Cable entry from the top: Motor cables	M78	✓ ²⁾	✓ ²⁾	✓ ²⁾	✓ ²⁾	✓ ²⁾	✓ ²⁾	✓ ²⁾	✓ ²⁾	✓ ²⁾	✓ ²⁾	✓ ²⁾	✓ ²⁾
Special control cabinet paint color: Please specify RAL	Y09 • and identification code	✓	✓	✓	✓	✓	✓	✓	✓	✓	✓	✓	✓
Window in door for viewing internal components	Y19 • and identification code	✓	✓	✓	✓	✓	✓	✓	✓	✓	✓	✓	✓
Control elements and display instruments in control cabinet door													
SENTRON PAC3200 power monitoring device (without current transformer)	G10	✓	✓	✓	✓	✓	✓	✓	✓	✓	✓	✓	✓
SENTRON PAC3200 power monitoring device (with current transformer)	G11	✓	✓	✓	✓	✓	✓	✓	✓	✓	✓	✓	✓
External 4-line operator panel, supplied separately packed	K14	✓	✓	✓	✓	✓	✓	✓	✓	✓	✓	✓	✓
External 4-line operator panel integrated in control cabinet door	K15	✓	✓	✓	✓	✓	✓	✓	✓	✓	✓	✓	✓
Selector switch in form of key-operated switch	K37	✓	✓	✓	✓	✓	✓	✓	✓	✓	✓	✓	✓
Accessories													
Grounding socket outlet 230 V, 50 Hz, 10 A, in control cabinet with 30 mA ground-fault circuit interrupter, external incoming supply	L48	✓	✓	✓	✓	✓	✓	✓	✓	✓	✓	✓	✓
Socket outlet 230 V, 50 Hz, 1 A, in control cabinet with 30 mA ground-fault circuit interrupter, supplied internally	L49	✓	✓	✓	✓	✓	✓	✓	✓	✓	✓	✓	✓
Magnetically attached cabinet light and door contact switch	L50	✓	✓	✓	✓	✓	✓	✓	✓	✓	✓	✓	✓
Cabinet heater to protect against condensation and/or for operation with supply air temperature of -5 °C or below	L55	✓	✓	✓	✓	✓	✓	✓	✓	✓	✓	✓	✓
Controlled outgoing feeder for motor heater, 230 V 1 AC, max. 4 kW	N35	✓	✓	✓	✓	✓	✓	✓	✓	✓	✓	✓	✓
Controlled outgoing feeder for external motor fan, external fan voltage for 3 AC. Converter line voltage, max. 4 kW	N36	✓	✓	✓	✓	✓	✓	✓	✓	✓	✓	✓	✓

For legends and footnotes, see Page 2/38.

SINAMICS G180

SINAMICS G180 compact units and SINAMICS G180 cabinet systems

SINAMICS G180 cabinet systems

Options (continued)

Option text	Additional ordering data -Z with order code and, if necessary, with plain text specification	SINAMICS G180 cabinet systems (compact units installed in a control cabinet)											
		400 V TN/TT system						500 V IT system					
Version – see selection and ordering data													
		A	B	C	D	E	F	G	H	I	J	K	L
Accessories (continued)													
Undervoltage release for main switch or circuit breaker; specify coil voltage	Y11 • and identification code	–	–	–	✓	✓	✓	–	–	–	✓	✓	✓
Controlled outgoing feeder for auxiliary drive up to max. 4 kW; please specify type of drive, voltage, number of phases	Y98 • and identification code	✓ ¹⁾	✓ ¹⁾	✓ ¹⁾	✓ ¹⁾	✓ ¹⁾	✓ ¹⁾	✓ ¹⁾	✓ ¹⁾	✓ ¹⁾	✓ ¹⁾	✓ ¹⁾	✓ ¹⁾
Marking of cable cores and items of equipment													
Dual marking of items of equipment	M96	✓	✓	✓	✓	✓	✓	✓	✓	✓	✓	✓	✓
Cable marking, C-type	M93	✓	✓	✓	✓	✓	✓	✓	✓	✓	✓	✓	✓
Cable marking (shrink-on sleeve)	M94	✓	✓	✓	✓	✓	✓	✓	✓	✓	✓	✓	✓
Wiring options													
Cross-section of cables installed inside cabinet 1.5 mm ²	M20	✓	✓	✓	✓	✓	✓	✓	✓	✓	✓	✓	✓
Use of halogen-free cables inside cabinet	N50	✓	✓	✓	✓	✓	✓	✓	✓	✓	✓	✓	✓
Other options													
Board for mains supply backup	E85	x	x	x	x	x	x	x	x	x	x	x	x
Peripheral boards													
Peripheral board 1	G02	✓	✓	✓	✓	✓	✓	✓	✓	✓	✓	✓	✓
Peripheral board 2	G03	✓	✓	✓	✓	✓	✓	✓	✓	✓	✓	✓	✓
Peripheral board 3	G04	✓	✓	✓	✓	✓	✓	✓	✓	✓	✓	✓	✓
Peripheral board 4	G05	✓	✓	✓	✓	✓	✓	✓	✓	✓	✓	✓	✓
Additional boards for bus connection													
Board for PROFIBUS DPV1	G01	✓	✓	✓	✓	✓	✓	✓	✓	✓	✓	✓	✓
PROFIBUS expansion module for option G10 or G11 (SENTRON PAC3200 power monitoring device)	G12	✓	✓	✓	✓	✓	✓	✓	✓	✓	✓	✓	✓
Board for CANopen	G20	✓	✓	✓	✓	✓	✓	✓	✓	✓	✓	✓	✓
Board for Modbus RTU	G22	✓	✓	✓	✓	✓	✓	✓	✓	✓	✓	✓	✓
Board for Modbus TCP	G27	✓	✓	✓	✓	✓	✓	✓	✓	✓	✓	✓	✓
Accessories for IMS													
USB PROFIBUS interface (supplied separately packed)	G13	✓	✓	✓	✓	✓	✓	✓	✓	✓	✓	✓	✓
Ethernet-PROFIBUS gateway	G14	✓	✓	✓	✓	✓	✓	✓	✓	✓	✓	✓	✓
Ethernet-to-RS232/485/422 converter (supplied separately packed)	G15	✓	✓	✓	✓	✓	✓	✓	✓	✓	✓	✓	✓
USB cable A/B (supplied separately packed)	G16	✓	✓	✓	✓	✓	✓	✓	✓	✓	✓	✓	✓
USB connector on front of control cabinet door	G18	✓	✓	✓	✓	✓	✓	✓	✓	✓	✓	✓	✓
Extension of the liability for defects													
Extension of the liability for defects by 12 months as of commissioning date or by 24 months as of delivery date	Q80	✓	✓	✓	✓	✓	✓	✓	✓	✓	✓	✓	✓
Extension of the liability for defects by 18 months as of commissioning date or by 30 months as of delivery date	Q81	✓	✓	✓	✓	✓	✓	✓	✓	✓	✓	✓	✓
Extension of the liability for defects by 24 months as of commissioning date or by 36 months as of delivery date	Q82	✓	✓	✓	✓	✓	✓	✓	✓	✓	✓	✓	✓
Extension of the liability for defects by 30 months as of commissioning date or by 42 months as of delivery date	Q83	✓	✓	✓	✓	✓	✓	✓	✓	✓	✓	✓	✓
Extension of the liability for defects by 36 months as of commissioning date or by 48 months as of delivery date	Q84	✓	✓	✓	✓	✓	✓	✓	✓	✓	✓	✓	✓
Extension of the liability for defects by 48 months as of commissioning date or by 60 months as of delivery date	Q85	✓	✓	✓	✓	✓	✓	✓	✓	✓	✓	✓	✓

For legends and footnotes, see Page 2/38.

SINAMICS G180

SINAMICS G180 compact units and SINAMICS G180 cabinet systems

SINAMICS G180 cabinet systems

Options (continued)

Option text	Additional ordering data -Z with order code and, if necessary, with plain text specification	SINAMICS G180 cabinet systems (compact units installed in a control cabinet)											
		400 V TN/TT system						500 V IT system					
Version – see selection and ordering data													
		A	B	C	D	E	F	G	H	I	J	K	L
Label for plant identification													
Cabinet designation TAG/ITEM number according to ordering data	T01	✓	✓	✓	✓	✓	✓	✓	✓	✓	✓	✓	✓
Customized labels	Y33 • and identification code	✓	✓	✓	✓	✓	✓	✓	✓	✓	✓	✓	✓
Ambient temperature for air-cooled converters													
45 °C ambient temperature (with corresponding derating)	V61	✓	✓	✓	✓	✓	✓	✓	✓	✓	✓	✓	✓
50 °C ambient temperature (with corresponding derating)	V62	✓	✓	✓	✓	✓	✓	✓	✓	✓	✓	✓	✓
Installation altitude													
Installation altitude max. 1500 m above sea level (with corresponding derating)	V86	✓	✓	✓	✓	✓	✓	✓	✓	✓	✓	✓	✓
Installation altitude max. 2000 m above sea level (with corresponding derating)	V87	✓	✓	✓	✓	✓	✓	✓	✓	✓	✓	✓	✓
Installation altitude max. 2500 m above sea level (with corresponding derating)	V88	✓	✓	✓	✓	✓	✓	✓	✓	✓	✓	✓	✓
Installation altitude max. 3000 m above sea level (with corresponding derating)	V89	✓	✓	✓	✓	✓	✓	✓	✓	✓	✓	✓	✓
Acceptance tests for converters													
Routine test under no-load conditions with customer present	F71	✓	✓	✓	✓	✓	✓	✓	✓	✓	✓	✓	✓
Routine test with 1PS or 1MD motor (ordered with converter in package), under no-load conditions (without customer present)	F72	✓	✓	✓	✓	✓	✓	✓	✓	✓	✓	✓	✓
Routine test with 1PS or 1MD motor (ordered with converter in package), under no-load conditions with customer present	F73	✓	✓	✓	✓	✓	✓	✓	✓	✓	✓	✓	✓
Visual inspection and function test under rated load using test bay motor (without customer present)	F80	✓	✓	✓	✓	✓	✓	✓	✓	✓	✓	✓	✓
Visual inspection and function test under rated load using test bay motor with customer present	F81	✓	✓	✓	✓	✓	✓	✓	✓	✓	✓	✓	✓
Visual inspection and function test under rated load with 1PS or 1MD motor (ordered with converter in package) (without customer present)	F82	✓	✓	✓	✓	✓	✓	✓	✓	✓	✓	✓	✓
Visual inspection and function test under rated load with 1PS or 1MD motor (ordered with converter in package) with customer present	F83	✓	✓	✓	✓	✓	✓	✓	✓	✓	✓	✓	✓
Advanced visual inspection and function test under rated load with 1PS or 1MD motor (ordered with converter in package) (without customer present)	F84	✓	✓	✓	✓	✓	✓	✓	✓	✓	✓	✓	✓
Advanced visual inspection and function test under rated load with 1PS or 1MD motor (ordered with converter in package) with customer present	F85	✓	✓	✓	✓	✓	✓	✓	✓	✓	✓	✓	✓
Supplementary documentation													
Test sequence schedule	B48	✓	✓	✓	✓	✓	✓	✓	✓	✓	✓	✓	✓
Spare parts price list	B38	✓	✓	✓	✓	✓	✓	✓	✓	✓	✓	✓	✓
Production flowchart: Generated once	B43	✓	✓	✓	✓	✓	✓	✓	✓	✓	✓	✓	✓
Production flowchart: Generated once per month	B45	✓	✓	✓	✓	✓	✓	✓	✓	✓	✓	✓	✓
Converter display language													
Display language Norwegian/English	T23	✓	✓	✓	✓	✓	✓	✓	✓	✓	✓	✓	✓
Display language Swedish/English	T24	✓	✓	✓	✓	✓	✓	✓	✓	✓	✓	✓	✓
Display language Czech/English	T25	✓	✓	✓	✓	✓	✓	✓	✓	✓	✓	✓	✓
Display language Hungarian/English	T26	✓	✓	✓	✓	✓	✓	✓	✓	✓	✓	✓	✓
Display language French/English	T58	✓	✓	✓	✓	✓	✓	✓	✓	✓	✓	✓	✓

For legends and footnotes, see Page 2/38.

SINAMICS G180

SINAMICS G180 compact units and SINAMICS G180 cabinet systems

SINAMICS G180 cabinet systems

Options (continued)

Option text	Additional ordering data -Z with order code and, if necessary, with plain text specification	SINAMICS G180 cabinet systems (compact units installed in a control cabinet)											
		400 V TN/TT system						500 V IT system					
		A	B	C	D	E	F	G	H	I	J	K	L
Converter display language (continued)													
Display language Spanish/English	T60	✓	✓	✓	✓	✓	✓	✓	✓	✓	✓	✓	✓
Display language German/English	T74	✓	✓	✓	✓	✓	✓	✓	✓	✓	✓	✓	✓
Display language English/German	T76	✓	✓	✓	✓	✓	✓	✓	✓	✓	✓	✓	✓
Display language Portuguese/English	T82	✓	✓	✓	✓	✓	✓	✓	✓	✓	✓	✓	✓
Display language Russian/English	T85	✓	✓	✓	✓	✓	✓	✓	✓	✓	✓	✓	✓
Display language Polish/English	T86	✓	✓	✓	✓	✓	✓	✓	✓	✓	✓	✓	✓
Converter documentation													
Manual and set of diagrams in PDF format per e-mail, German/English	D01	☐	☐	☐	☐	☐	☐	☐	☐	☐	☐	☐	☐
Manual in PDF format, set of diagrams in DXF format per e-mail, German/English	D02	✓	✓	✓	✓	✓	✓	✓	✓	✓	✓	✓	✓
Manual and set of diagrams, single hardcopy, German/English	D04	✓	✓	✓	✓	✓	✓	✓	✓	✓	✓	✓	✓
Manual and set of diagrams in PDF format on CD, language: German/English	D05	✓	✓	✓	✓	✓	✓	✓	✓	✓	✓	✓	✓
Manual in PDF format, set of diagrams in DWG format on CD, German/English	D06	✓	✓	✓	✓	✓	✓	✓	✓	✓	✓	✓	✓
Language and manual													
Different language for manual	Y13 • and identification code	✓	✓	✓	✓	✓	✓	✓	✓	✓	✓	✓	✓
Certifications													
Gost R certificate	U04	✓	✓	✓	✓	✓	✓	✓	✓	✓	✓	✓	✓
Engineering (for description, see Page 4/34)													
Mechanical system		✓	✓	✓	✓	✓	✓	✓	✓	✓	✓	✓	✓
Parameterization		✓	✓	✓	✓	✓	✓	✓	✓	✓	✓	✓	✓
Electrical (power output, control)		✓	✓	✓	✓	✓	✓	✓	✓	✓	✓	✓	✓
Extended overvoltage range		✓	✓	✓	✓	✓	✓	– ⁴⁾	– ⁴⁾	– ⁴⁾	– ⁴⁾	– ⁴⁾	– ⁴⁾
Test bay converter		✓	✓	✓	✓	✓	✓	✓	✓	✓	✓	✓	✓
Special tests		✓	✓	✓	✓	✓	✓	✓	✓	✓	✓	✓	✓
Special documentation		✓	✓	✓	✓	✓	✓	✓	✓	✓	✓	✓	✓
Special version		✓	✓	✓	✓	✓	✓	✓	✓	✓	✓	✓	✓

✓ Available

☐ Standard version

– Not possible

× Not required

• This order code only determines the price of the version – additional plain text is required.

¹⁾ Voltage between 230 and 500 V.

²⁾ Please ask your Siemens contact person for the exact cabinet dimensions.

³⁾ Additional option included in the original option.

⁴⁾ 690 V compact units + the next-higher rating must be selected for the "Extended overvoltage range" function.

SINAMICS G180

SINAMICS G180 compact units and SINAMICS G180 cabinet systems

SINAMICS G180 cabinet systems

Options (continued)

Option text	Additional ordering data -Z with order code and, if necessary, with plain text specification	SINAMICS G180 cabinet systems (compact units installed in a control cabinet)									
		690 V TN/TT system					690 V IT system				
Version – see selection and ordering data											
		M	N	O	P	Q	R	S	T	U	V
Converter cabinet width											
406 mm	H80	✓	✓	–	–	–	✓	✓	–	–	–
606 mm	H81	□	□	□	□	□	□	□	□	□	□
806 mm	H82	✓	✓	✓	✓	✓	✓	✓	✓	✓	✓
1006 mm	H83	✓	✓	✓	✓	✓	✓	✓	✓	✓	✓
1206 mm	H84	✓	✓	✓	✓	✓	✓	✓	✓	✓	✓
1406 mm	H85	✓	✓	✓	✓	✓	✓	✓	✓	✓	✓
1606 mm	H86	✓	✓	✓	✓	✓	✓	✓	✓	✓	✓
Additional cabinet											
400 mm	H90	✓	✓	✓	✓	✓	✓	✓	✓	✓	✓
600 mm	H91	✓	✓	✓	✓	✓	✓	✓	✓	✓	✓
800 mm	H92	✓	✓	✓	✓	✓	✓	✓	✓	✓	✓
1000 mm	H93	✓	✓	✓	✓	✓	✓	✓	✓	✓	✓
1200 mm	H94	✓	✓	✓	✓	✓	✓	✓	✓	✓	✓
Line voltages											
Line voltage 380 V, 50 Hz	V70	✓	✓	✓	✓	✓	✓	✓	✓	✓	✓
Line voltage 400 V, 50 Hz	V71	✓	✓	✓	✓	✓	✓	✓	✓	✓	✓
Line voltage 415 V, 50 Hz	V72	✓	✓	✓	✓	✓	✓	✓	✓	✓	✓
Line voltage 500 V, 50 Hz	V73	✓	✓	✓	✓	✓	✓	✓	✓	✓	✓
Line voltage 660 V, 50 Hz	V74	✓	✓	✓	✓	✓	✓	✓	✓	✓	✓
Line voltage 690 V, 50 Hz	V75	✓	✓	✓	✓	✓	✓	✓	✓	✓	✓
Line voltage 440 V, 60 Hz	V76	✓	✓	✓	✓	✓	✓	✓	✓	✓	✓
Line voltage 460 V, 60 Hz	V77	✓	✓	✓	✓	✓	✓	✓	✓	✓	✓
Line voltage 480 V, 60 Hz	V78	✓	✓	✓	✓	✓	✓	✓	✓	✓	✓
Line voltage 600 V, 60 Hz	V79	✓	✓	✓	✓	✓	✓	✓	✓	✓	✓
Line voltage 660 V, 60 Hz	V80	✓	✓	✓	✓	✓	✓	✓	✓	✓	✓
Special line voltage; please specify voltage	Y70 • and identification code	✓ ¹⁾	✓ ¹⁾	✓ ¹⁾	✓ ¹⁾	✓ ¹⁾	✓ ¹⁾	✓ ¹⁾	✓ ¹⁾	✓ ¹⁾	✓ ¹⁾
External auxiliary power supply											
Connection for 230 V 1 AC 50 Hz auxiliary voltage provided by customer	C36	✓	✓	✓	✓	✓	✓	✓	✓	✓	✓
Connection for 400 V 3 AC 50 Hz auxiliary voltage provided by customer	C38	✓	✓	✓	✓	✓	✓	✓	✓	✓	✓
Connection for 500 V 3 AC 50 Hz auxiliary voltage provided by customer	C43	✓	✓	✓	✓	✓	✓	✓	✓	✓	✓
Connection for 690 V 3 AC 50 Hz auxiliary voltage provided by customer	C48	✓	✓	✓	✓	✓	✓	✓	✓	✓	✓
Connection for other 3 AC voltage provided by customer; please specify voltage	Y36 • and identification code	✓	✓	✓	✓	✓	✓	✓	✓	✓	✓
External control voltage supply											
Connection for 230 V 1 AC 50 Hz control voltage provided by customer, without UPS backup	C56	✓	✓	✓	✓	✓	✓	✓	✓	✓	✓
Connection for 230 V 1 AC 50 Hz control voltage provided by customer, with UPS backup	C57	✓	✓	✓	✓	✓	✓	✓	✓	✓	✓
Connection for different 1 AC control voltage (47 to 63 Hz) provided by customer; please specify voltage	Y55 • and identification code	✓	✓	✓	✓	✓	✓	✓	✓	✓	✓
RFI suppression filter											
RFI suppression filter, category C2 or C3 (class A)	L00	□	□	□	□	□	–	–	–	–	–
RFI suppression filter, category C1 (class B)	L02	✓	✓	✓	✓	✓	–	–	–	–	–
Line Harmonics Filter											
Line Harmonics Filter for 50 Hz line frequency up to 500 V	L03	H81 ⁽³⁾	H82 ⁽³⁾	H82 ⁽³⁾	H81 ⁽³⁾ + H91 ⁽³⁾	H81 ⁽³⁾ + H91 ⁽³⁾	H81 ⁽³⁾	H82 ⁽³⁾	H82 ⁽³⁾	H81 ⁽³⁾ + H91 ⁽³⁾	H81 ⁽³⁾ + H91 ⁽³⁾
Line Harmonics Filter for 60 Hz line frequency up to 480 V	L04	H81 ⁽³⁾	H82 ⁽³⁾	H82 ⁽³⁾	H81 ⁽³⁾ + H91 ⁽³⁾	H81 ⁽³⁾ + H91 ⁽³⁾	H81 ⁽³⁾	H82 ⁽³⁾	H82 ⁽³⁾	H81 ⁽³⁾ + H91 ⁽³⁾	H81 ⁽³⁾ + H91 ⁽³⁾

For legends and footnotes, see Page 2/45.

SINAMICS G180

SINAMICS G180 compact units and SINAMICS G180 cabinet systems

SINAMICS G180 cabinet systems

Options (continued)

Option text	Additional ordering data -Z with order code and, if necessary, with plain text specification	SINAMICS G180 cabinet systems (compact units installed in a control cabinet)										
		690 V TN/TT system						690 V IT system				
Version – see selection and ordering data												
		M	N	O	P	Q	R	S	T	U	V	
Output filter												
Strengthened dv/dt output filter for max. 250/300 m (type-dependent). Design for longer motor cables available on request	L10	✓	✓	✓	✓	H82 ³⁾	✓	✓	✓	✓	H82 ³⁾	
Sine-wave filter integrated in control cabinet, suitable for motor frequencies of ≤ 75 Hz, voltage drop of approximately 5 % of line voltage	L17	✓	✓	✓	✓	H81 ³⁾ + H92 ³⁾	✓	✓	✓	✓	H81 ³⁾ + H92 ³⁾	
Standard accessories packages												
Peripheral board 4 (G05) instead of peripheral board 2 (G03) (only in conjunction with package S01, S02, S03, S04, S08, S09, S11, S12)	G08	✓	✓	✓	✓	✓	✓	✓	✓	✓	✓	
Accessories package S01 with main switch, line contactor, EMERGENCY OFF pushbutton and safety relay, board G03, local/remote switch	S01	✓	✓	✓	✓	✓	✓	✓	✓	✓	✓	
Accessories package S02 with circuit breaker, line contactor, EMERGENCY OFF pushbutton and safety relay, board G03, local/remote switch	S02	✓	✓	✓	✓	✓	✓	✓	✓	✓	✓	
Accessories package with main switch, line contactor, board G03, local/remote switch	S03	✓	✓	✓	✓	✓	✓	✓	✓	✓	✓	
Accessories package with circuit breaker, line contactor, board G03, local/remote switch	S04	✓	✓	✓	✓	✓	✓	✓	✓	✓	✓	
Accessories package with main switch, line contactor, Calomat, RCU box connection	S06	✓	✓	✓	✓	✓	✓	✓	✓	✓	✓	
Bypass for smooth line synchronization (soft start function) incl. line-side main switch and contactors at the converter output and in bypass	S08	✓	✓	✓	H82 ³⁾	H83 ³⁾	✓	✓	✓	H82 ³⁾	H83 ³⁾	
Bypass for smooth line synchronization (soft start function) incl. line-side circuit breaker and contactors at the converter output and in bypass	S09	✓	✓	✓	H82 ³⁾	H83 ³⁾	✓	✓	✓	H82 ³⁾	H83 ³⁾	
Accessories package S11 with line-side main switch, board G03, local/remote switch	S11	✓	✓	✓	✓	✓	✓	✓	✓	✓	✓	
Accessories package S12 with line-side circuit breaker, board G03, local/remote switch	S12	✓	✓	✓	✓	✓	✓	✓	✓	✓	✓	
Bypass with line-side main switch, contactors at converter output and in bypass, switchover between manual and automatic, local/remote switch	S21	✓	✓	✓	H82 ³⁾	H83 ³⁾	✓	✓	✓	H82 ³⁾	H83 ³⁾	
Bypass with line-side circuit breaker, contactors at converter output and in bypass, switchover between manual and automatic, local/remote switch	S22	✓	✓	✓	H82 ³⁾	H83 ³⁾	✓	✓	✓	H82 ³⁾	H83 ³⁾	
Bypass with line-side main switch, contactors at converter output and in bypass, EMERGENCY OFF safety relay, switchover between manual and automatic, local/remote switch	S23	✓	✓	✓	H82 ³⁾	H83 ³⁾	✓	✓	✓	H82 ³⁾	H83 ³⁾	
Bypass with line-side circuit breaker, contactors at converter output and in bypass, EMERGENCY OFF safety relay, switchover between manual and automatic, local/remote switch	S24	✓	✓	✓	H82 ³⁾	H83 ³⁾	✓	✓	✓	H82 ³⁾	H83 ³⁾	
NAMUR accessories package with Test/Normal operation switch, option G05, terminal strip compliant with NAMUR NE37 (without main switch)	S31	✓	✓	✓	✓	✓	✓	✓	✓	✓	✓	
NAMUR accessories package with Test/Normal operation switch, main switch, line contactor, option G05, terminal strip compliant with NAMUR NE37	S32	✓	✓	✓	✓	✓	✓	✓	✓	✓	✓	

For legends and footnotes, see Page 2/45.

Options (continued)

Option text	Additional ordering data -Z with order code and, if necessary, with plain text specification	SINAMICS G180 cabinet systems (compact units installed in a control cabinet)										
		690 V TN/TT system						690 V IT system				
Version – see selection and ordering data												
		M	N	O	P	Q	R	S	T	U	V	
Braking chopper												
Braking chopper integrated into converter (braking resistor is not included and must be ordered separately)	L72	✓	✓	✓	✓	✓	✓	✓	✓	✓	✓	
CALOMAT CK145												
CALOMAT CK145 without storage for motor temperature prewarning	L80	✓	✓	✓	✓	✓	✓	✓	✓	✓	✓	
CALOMAT CK145 with storage for motor temperature trip	L81	✓	✓	✓	✓	✓	✓	✓	✓	✓	✓	
CALOMAT CK145 without storage for transformer temperature prewarning	L82	✓	✓	✓	✓	✓	✓	✓	✓	✓	✓	
CALOMAT CK145 with storage for transformer temperature trip	L83	✓	✓	✓	✓	✓	✓	✓	✓	✓	✓	
CALOMAT CK145 for other PTC thermistor monitoring functions	Y80 • and identification code	✓	✓	✓	✓	✓	✓	✓	✓	✓	✓	
Pt100 evaluation unit												
Pt100 evaluation unit for motor winding temperature, integrated in control cabinet for monitoring of 3 × Pt100 or 3 × KTY83/84 sensors	L90	✓	✓	✓	✓	✓	✓	✓	✓	✓	✓	
Pt100 evaluation unit for motor bearing temperature, integrated in control cabinet for monitoring of 2 × Pt100 or 2 × KTY83/84 sensors	L91	✓	✓	✓	✓	✓	✓	✓	✓	✓	✓	
Pt100 evaluation unit for motor winding temperature, integrated in cabinet for monitoring 3 × Pt100 sensors; plus an analog output 0 to 10 V or 0(4) to 20 mA connected to terminals for the hottest winding temperature	L92	✓	✓	✓	✓	✓	✓	✓	✓	✓	✓	
Pt100 evaluation unit for motor bearing temperature, integrated in cabinet for monitoring 2 × Pt100 sensors or 2 × KTY83/84 sensors; plus two analog outputs 0 to 10 V or 0(4) to 20 mA connected to terminals for bearing temperature	L93	✓	✓	✓	✓	✓	✓	✓	✓	✓	✓	
Pt100 evaluation unit for motor winding and bearing temperatures, integrated in cabinet for monitoring 6 × Pt100 sensors; plus two analog outputs 0 to 10 V or 0(4) to 20 mA connected to terminals for the hottest winding and bearing temperatures	L94	✓	✓	✓	✓	✓	✓	✓	✓	✓	✓	
Pt100 evaluation unit for other temperature monitoring functions, integrated in cabinet for monitoring of 3 × Pt100 or 3 × KTY83/84 sensors	Y90 • and identification code	✓	✓	✓	✓	✓	✓	✓	✓	✓	✓	
Pt100 evaluation unit for other temperature monitoring functions, integrated in cabinet for monitoring 6 × Pt100 sensors; plus two analog outputs 0 to 10 V or 0(4) to 20 mA connected to terminals	Y94 • and identification code	✓	✓	✓	✓	✓	✓	✓	✓	✓	✓	
Degrees of protection												
Increased degree of protection IP41 for air-cooled cabinet units and systems	M41	✓	✓	✓	✓	✓	✓	✓	✓	✓	✓	
Increased degree of protection IP43 for air-cooled cabinet units and systems	M43	✓	✓	✓	✓	✓	✓	✓	✓	✓	✓	
Increased degree of protection IP54 for air-cooled cabinet units and systems; not suitable for outdoor applications	M54	✓	✓	✓	✓	✓	✓	✓	✓	✓	✓	
Air flange for connection to customer's exhaust air systems (air outlet IP00)	M63	✓	✓	✓	✓	✓	✓	✓	✓	✓	✓	

For legends and footnotes, see Page 2/45.

SINAMICS G180

SINAMICS G180 compact units and SINAMICS G180 cabinet systems

SINAMICS G180 cabinet systems

Options (continued)

Option text	Additional ordering data -Z with order code and, if necessary, with plain text specification	SINAMICS G180 cabinet systems (compact units installed in a control cabinet)										
		690 V TN/TT system						690 V IT system				
Version – see selection and ordering data												
		M	N	O	P	Q	R	S	T	U	V	
Cabinet options												
Control cabinet base, welded and suitable for use with transport rollers, in RAL 7035, h = 200 mm	M05	✓	✓	✓	✓	✓	✓	✓	✓	✓	✓	
Control cabinet base, standard version in RAL 7022/9005, h = 100 mm	M06	✓	✓	✓	✓	✓	✓	✓	✓	✓	✓	
Control cabinet base, standard version in RAL 7022/9005, h = 200 mm	M07	✓	✓	✓	✓	✓	✓	✓	✓	✓	✓	
Cable entry from the top: Power cable	M13	✓ ⁽²⁾	✓ ⁽²⁾	✓ ⁽²⁾	✓ ⁽²⁾	✓ ⁽²⁾	✓ ⁽²⁾	✓ ⁽²⁾	✓ ⁽²⁾	✓ ⁽²⁾	✓ ⁽²⁾	
Door opening angle 180°	M17	✓	✓	✓	✓	✓	✓	✓	✓	✓	✓	
Window in door for viewing internal display	M19	✓	✓	✓	✓	✓	✓	✓	✓	✓	✓	
Partitions between compact units for cabinet systems	M24	✓	✓	✓	✓	✓	✓	✓	✓	✓	✓	
Door hinge on left	M28	✓	✓	✓	✓	✓	✓	✓	✓	✓	✓	
Cable entry from the top: Control cables	M34	✓ ⁽²⁾	✓ ⁽²⁾	✓ ⁽²⁾	✓ ⁽²⁾	✓ ⁽²⁾	✓ ⁽²⁾	✓ ⁽²⁾	✓ ⁽²⁾	✓ ⁽²⁾	✓ ⁽²⁾	
Comfort-grip handle with double-bit key lock	M38	✓	✓	✓	✓	✓	✓	✓	✓	✓	✓	
Comfort-grip handle with integrated pushbutton	M39	✓	✓	✓	✓	✓	✓	✓	✓	✓	✓	
Comfort-grip handle with cylinder lock	M40	✓	✓	✓	✓	✓	✓	✓	✓	✓	✓	
Air supply via cable floor. No filter mats required in door	M59	✓	✓	✓	✓	✓	✓	✓	✓	✓	✓	
Cable entry from the top: Motor cables	M78	✓ ⁽²⁾	✓ ⁽²⁾	✓ ⁽²⁾	✓ ⁽²⁾	✓ ⁽²⁾	✓ ⁽²⁾	✓ ⁽²⁾	✓ ⁽²⁾	✓ ⁽²⁾	✓ ⁽²⁾	
Special control cabinet paint color: Please specify RAL	Y09 • and identification code	✓	✓	✓	✓	✓	✓	✓	✓	✓	✓	
Window in door for viewing internal components	Y19 • and identification code	✓	✓	✓	✓	✓	✓	✓	✓	✓	✓	
Control elements and display instruments in control cabinet door												
SETRON PAC3200 power monitoring device (without current transformer)	G10	✓	✓	✓	✓	✓	✓	✓	✓	✓	✓	
SETRON PAC3200 power monitoring device (with current transformer)	G11	✓	✓	✓	✓	✓	✓	✓	✓	✓	✓	
External 4-line operator panel, supplied separately packed	K14	✓	✓	✓	✓	✓	✓	✓	✓	✓	✓	
External 4-line operator panel integrated in control cabinet door	K15	✓	✓	✓	✓	✓	✓	✓	✓	✓	✓	
Selector switch in form of key-operated switch	K37	✓	✓	✓	✓	✓	✓	✓	✓	✓	✓	
Accessories												
Grounding socket outlet 230 V, 50 Hz, 10 A, in control cabinet with 30 mA ground-fault circuit interrupter, external incoming supply	L48	✓	✓	✓	✓	✓	✓	✓	✓	✓	✓	
Socket outlet 230 V, 50 Hz, 1 A, in control cabinet with 30 mA ground-fault circuit interrupter, supplied internally	L49	✓	✓	✓	✓	✓	✓	✓	✓	✓	✓	
Magnetically attached cabinet light and door contact switch	L50	✓	✓	✓	✓	✓	✓	✓	✓	✓	✓	
Cabinet heater to protect against condensation and/or for operation with supply air temperature of -5 °C or below	L55	✓	✓	✓	✓	✓	✓	✓	✓	✓	✓	
Controlled outgoing feeder for motor heater, 230 V 1 AC, max. 4 kW	N35	✓	✓	✓	✓	✓	✓	✓	✓	✓	✓	
Controlled outgoing feeder for external motor fan, external fan voltage for 3 AC. Converter line voltage, max. 4 kW	N36	✓	✓	✓	✓	✓	✓	✓	✓	✓	✓	
Undervoltage release for main switch or circuit breaker; specify coil voltage	Y11 • and identification code	–	–	–	✓	✓	–	–	–	✓	✓	
Controlled outgoing feeder for auxiliary drive up to max. 4 kW; please specify type of drive, voltage, number of phases	Y98 • and identification code	✓ ⁽¹⁾	✓ ⁽¹⁾	✓ ⁽¹⁾	✓ ⁽¹⁾	✓ ⁽¹⁾	✓ ⁽¹⁾	✓ ⁽¹⁾	✓ ⁽¹⁾	✓ ⁽¹⁾	✓ ⁽¹⁾	

For legends and footnotes, see Page 2/45.

SINAMICS G180

SINAMICS G180 compact units and SINAMICS G180 cabinet systems

SINAMICS G180 cabinet systems

Options (continued)

Option text	Additional ordering data -Z with order code and, if necessary, with plain text specification	SINAMICS G180 cabinet systems (compact units installed in a control cabinet)										
		690 V TN/TT system						690 V IT system				
Version – see selection and ordering data												
		M	N	O	P	Q	R	S	T	U	V	
Marking of cable cores and items of equipment												
Dual marking of items of equipment	M96	✓	✓	✓	✓	✓	✓	✓	✓	✓	✓	
Cable marking, C-type	M93	✓	✓	✓	✓	✓	✓	✓	✓	✓	✓	
Cable marking (shrink-on sleeve)	M94	✓	✓	✓	✓	✓	✓	✓	✓	✓	✓	
Wiring options												
Cross-section of cables installed inside cabinet 1.5 mm ²	M20	✓	✓	✓	✓	✓	✓	✓	✓	✓	✓	
Use of halogen-free cables inside cabinet	N50	✓	✓	✓	✓	✓	✓	✓	✓	✓	✓	
Other options												
Board for mains supply backup	E85	□	□	✓	✓	✓	□	□	✓	✓	✓	
Peripheral boards												
Peripheral board 1	G02	✓	✓	✓	✓	✓	✓	✓	✓	✓	✓	
Peripheral board 2	G03	✓	✓	✓	✓	✓	✓	✓	✓	✓	✓	
Peripheral board 3	G04	✓	✓	✓	✓	✓	✓	✓	✓	✓	✓	
Peripheral board 4	G05	✓	✓	✓	✓	✓	✓	✓	✓	✓	✓	
Additional boards for bus connection												
Board for PROFIBUS DPV1	G01	✓	✓	✓	✓	✓	✓	✓	✓	✓	✓	
PROFIBUS expansion module for option G10 or G11 (SENTRON PAC3200 power monitoring device)	G12	✓	✓	✓	✓	✓	✓	✓	✓	✓	✓	
Board for CANopen	G20	✓	✓	✓	✓	✓	✓	✓	✓	✓	✓	
Board for Modbus RTU	G22	✓	✓	✓	✓	✓	✓	✓	✓	✓	✓	
Board for Modbus TCP	G27	✓	✓	✓	✓	✓	✓	✓	✓	✓	✓	
Accessories for IMS												
USB PROFIBUS interface (supplied separately packed)	G13	✓	✓	✓	✓	✓	✓	✓	✓	✓	✓	
Ethernet-PROFIBUS gateway	G14	✓	✓	✓	✓	✓	✓	✓	✓	✓	✓	
Ethernet-to-RS232/485/422 converter (supplied separately packed)	G15	✓	✓	✓	✓	✓	✓	✓	✓	✓	✓	
USB cable A/B (supplied separately packed)	G16	✓	✓	✓	✓	✓	✓	✓	✓	✓	✓	
USB connector on front of control cabinet door	G18	✓	✓	✓	✓	✓	✓	✓	✓	✓	✓	
Extension of the liability for defects												
Extension of the liability for defects by 12 months as of commissioning date or by 24 months as of delivery date	Q80	✓	✓	✓	✓	✓	✓	✓	✓	✓	✓	
Extension of the liability for defects by 18 months as of commissioning date or by 30 months as of delivery date	Q81	✓	✓	✓	✓	✓	✓	✓	✓	✓	✓	
Extension of the liability for defects by 24 months as of commissioning date or by 36 months as of delivery date	Q82	✓	✓	✓	✓	✓	✓	✓	✓	✓	✓	
Extension of the liability for defects by 30 months as of commissioning date or by 42 months as of delivery date	Q83	✓	✓	✓	✓	✓	✓	✓	✓	✓	✓	
Extension of the liability for defects by 36 months as of commissioning date or by 48 months as of delivery date	Q84	✓	✓	✓	✓	✓	✓	✓	✓	✓	✓	
Extension of the liability for defects by 48 months as of commissioning date or by 60 months as of delivery date	Q85	✓	✓	✓	✓	✓	✓	✓	✓	✓	✓	
Label for plant identification												
Cabinet designation TAG/ITEM number according to ordering data	T01	✓	✓	✓	✓	✓	✓	✓	✓	✓	✓	
Customized labels	Y33 • and identification code	✓	✓	✓	✓	✓	✓	✓	✓	✓	✓	
Ambient temperature for air-cooled converters												
45 °C ambient temperature (with corresponding derating)	V61	✓	✓	✓	✓	✓	✓	✓	✓	✓	✓	
50 °C ambient temperature (with corresponding derating)	V62	✓	✓	✓	✓	✓	✓	✓	✓	✓	✓	

For legends and footnotes, see Page 2/45.

SINAMICS G180

SINAMICS G180 compact units and SINAMICS G180 cabinet systems

SINAMICS G180 cabinet systems

Options (continued)

Option text	Additional ordering data -Z with order code and, if necessary, with plain text specification	SINAMICS G180 cabinet systems (compact units installed in a control cabinet)									
		690 V TN/TT system					690 V IT system				
Version – see selection and ordering data											
		M	N	O	P	Q	R	S	T	U	V
Installation altitude											
Installation altitude max. 1500 m above sea level (with corresponding derating)	V86	✓	✓	✓	✓	✓	✓	✓	✓	✓	✓
Installation altitude max. 2000 m above sea level (with corresponding derating)	V87	✓	✓	✓	✓	✓	✓	✓	✓	✓	✓
Installation altitude max. 2500 m above sea level (with corresponding derating)	V88	✓	✓	✓	✓	✓	✓	✓	✓	✓	✓
Installation altitude max. 3000 m above sea level (with corresponding derating)	V89	✓	✓	✓	✓	✓	✓	✓	✓	✓	✓
Acceptance tests for converters											
Routine test under no-load conditions with customer present	F71	✓	✓	✓	✓	✓	✓	✓	✓	✓	✓
Routine test with 1PS or 1MD motor (ordered with converter in package), under no-load conditions (without customer present)	F72	✓	✓	✓	✓	✓	✓	✓	✓	✓	✓
Routine test with 1PS or 1MD motor (ordered with converter in package), under no-load conditions with customer present	F73	✓	✓	✓	✓	✓	✓	✓	✓	✓	✓
Visual inspection and function test under rated load using test bay motor (without customer present)	F80	✓	✓	✓	✓	✓	✓	✓	✓	✓	✓
Visual inspection and function test under rated load using test bay motor with customer present	F81	✓	✓	✓	✓	✓	✓	✓	✓	✓	✓
Visual inspection and function test under rated load with 1PS or 1MD motor (ordered with converter in package) (without customer present)	F82	✓	✓	✓	✓	✓	✓	✓	✓	✓	✓
Visual inspection and function test under rated load with 1PS or 1MD motor (ordered with converter in package) with customer present	F83	✓	✓	✓	✓	✓	✓	✓	✓	✓	✓
Advanced visual inspection and function test under rated load with 1PS or 1MD motor (ordered with converter in package) (without customer present)	F84	✓	✓	✓	✓	✓	✓	✓	✓	✓	✓
Advanced visual inspection and function test under rated load with 1PS or 1MD motor (ordered with converter in package) with customer present	F85	✓	✓	✓	✓	✓	✓	✓	✓	✓	✓
Supplementary documentation											
Test sequence schedule	B48	✓	✓	✓	✓	✓	✓	✓	✓	✓	✓
Spare parts price list	B38	✓	✓	✓	✓	✓	✓	✓	✓	✓	✓
Production flowchart: Generated once	B43	✓	✓	✓	✓	✓	✓	✓	✓	✓	✓
Production flowchart: Generated once per month	B45	✓	✓	✓	✓	✓	✓	✓	✓	✓	✓
Converter display language											
Display language Norwegian/English	T23	✓	✓	✓	✓	✓	✓	✓	✓	✓	✓
Display language Swedish/English	T24	✓	✓	✓	✓	✓	✓	✓	✓	✓	✓
Display language Czech/English	T25	✓	✓	✓	✓	✓	✓	✓	✓	✓	✓
Display language Hungarian/English	T26	✓	✓	✓	✓	✓	✓	✓	✓	✓	✓
Display language French/English	T58	✓	✓	✓	✓	✓	✓	✓	✓	✓	✓
Display language Spanish/English	T60	✓	✓	✓	✓	✓	✓	✓	✓	✓	✓
Display language German/English	T74	✓	✓	✓	✓	✓	✓	✓	✓	✓	✓
Display language English/German	T76	✓	✓	✓	✓	✓	✓	✓	✓	✓	✓
Display language Portuguese/English	T82	✓	✓	✓	✓	✓	✓	✓	✓	✓	✓
Display language Russian/English	T85	✓	✓	✓	✓	✓	✓	✓	✓	✓	✓
Display language Polish/English	T86	✓	✓	✓	✓	✓	✓	✓	✓	✓	✓

For legends and footnotes, see Page 2/45.

Options (continued)

Option text	Additional ordering data -Z with order code and, if necessary, with plain text specification	SINAMICS G180 cabinet systems (compact units installed in a control cabinet)										
		690 V TN/TT system						690 V IT system				
Version – see selection and ordering data												
		M	N	O	P	Q	R	S	T	U	V	
Converter documentation												
Manual and set of diagrams in PDF format per e-mail, German/English	D01	<input type="checkbox"/>	<input type="checkbox"/>	<input type="checkbox"/>	<input type="checkbox"/>	<input type="checkbox"/>	<input type="checkbox"/>	<input type="checkbox"/>	<input type="checkbox"/>	<input type="checkbox"/>	<input type="checkbox"/>	
Manual in PDF format, set of diagrams in DXF format per e-mail, German/English	D02	<input checked="" type="checkbox"/>	<input checked="" type="checkbox"/>	<input checked="" type="checkbox"/>	<input checked="" type="checkbox"/>	<input checked="" type="checkbox"/>	<input checked="" type="checkbox"/>	<input checked="" type="checkbox"/>	<input checked="" type="checkbox"/>	<input checked="" type="checkbox"/>	<input checked="" type="checkbox"/>	
Manual and set of diagrams, single hardcopy, German/English	D04	<input checked="" type="checkbox"/>	<input checked="" type="checkbox"/>	<input checked="" type="checkbox"/>	<input checked="" type="checkbox"/>	<input checked="" type="checkbox"/>	<input checked="" type="checkbox"/>	<input checked="" type="checkbox"/>	<input checked="" type="checkbox"/>	<input checked="" type="checkbox"/>	<input checked="" type="checkbox"/>	
Manual and set of diagrams in PDF format on CD, language: German/English	D05	<input checked="" type="checkbox"/>	<input checked="" type="checkbox"/>	<input checked="" type="checkbox"/>	<input checked="" type="checkbox"/>	<input checked="" type="checkbox"/>	<input checked="" type="checkbox"/>	<input checked="" type="checkbox"/>	<input checked="" type="checkbox"/>	<input checked="" type="checkbox"/>	<input checked="" type="checkbox"/>	
Manual in PDF format, set of diagrams in DWG format on CD, German/English	D06	<input checked="" type="checkbox"/>	<input checked="" type="checkbox"/>	<input checked="" type="checkbox"/>	<input checked="" type="checkbox"/>	<input checked="" type="checkbox"/>	<input checked="" type="checkbox"/>	<input checked="" type="checkbox"/>	<input checked="" type="checkbox"/>	<input checked="" type="checkbox"/>	<input checked="" type="checkbox"/>	
Language of manual												
Different language for manual	Y13 • and identification code	<input checked="" type="checkbox"/>	<input checked="" type="checkbox"/>	<input checked="" type="checkbox"/>	<input checked="" type="checkbox"/>	<input checked="" type="checkbox"/>	<input checked="" type="checkbox"/>	<input checked="" type="checkbox"/>	<input checked="" type="checkbox"/>	<input checked="" type="checkbox"/>	<input checked="" type="checkbox"/>	
Certifications												
Gost R certificate	U04	<input checked="" type="checkbox"/>	<input checked="" type="checkbox"/>	<input checked="" type="checkbox"/>	<input checked="" type="checkbox"/>	<input checked="" type="checkbox"/>	<input checked="" type="checkbox"/>	<input checked="" type="checkbox"/>	<input checked="" type="checkbox"/>	<input checked="" type="checkbox"/>	<input checked="" type="checkbox"/>	
Engineering (for description, see Page 4/34)												
Mechanical system		<input checked="" type="checkbox"/>	<input checked="" type="checkbox"/>	<input checked="" type="checkbox"/>	<input checked="" type="checkbox"/>	<input checked="" type="checkbox"/>	<input checked="" type="checkbox"/>	<input checked="" type="checkbox"/>	<input checked="" type="checkbox"/>	<input checked="" type="checkbox"/>	<input checked="" type="checkbox"/>	
Parameterization		<input checked="" type="checkbox"/>	<input checked="" type="checkbox"/>	<input checked="" type="checkbox"/>	<input checked="" type="checkbox"/>	<input checked="" type="checkbox"/>	<input checked="" type="checkbox"/>	<input checked="" type="checkbox"/>	<input checked="" type="checkbox"/>	<input checked="" type="checkbox"/>	<input checked="" type="checkbox"/>	
Electrical (power output, control)		<input checked="" type="checkbox"/>	<input checked="" type="checkbox"/>	<input checked="" type="checkbox"/>	<input checked="" type="checkbox"/>	<input checked="" type="checkbox"/>	<input checked="" type="checkbox"/>	<input checked="" type="checkbox"/>	<input checked="" type="checkbox"/>	<input checked="" type="checkbox"/>	<input checked="" type="checkbox"/>	
Extended overvoltage range		<input checked="" type="checkbox"/>	<input checked="" type="checkbox"/>	<input checked="" type="checkbox"/>	<input checked="" type="checkbox"/>	<input checked="" type="checkbox"/>	<input checked="" type="checkbox"/>	<input checked="" type="checkbox"/>	<input checked="" type="checkbox"/>	<input checked="" type="checkbox"/>	<input checked="" type="checkbox"/>	
Test bay converter		<input checked="" type="checkbox"/>	<input checked="" type="checkbox"/>	<input checked="" type="checkbox"/>	<input checked="" type="checkbox"/>	<input checked="" type="checkbox"/>	<input checked="" type="checkbox"/>	<input checked="" type="checkbox"/>	<input checked="" type="checkbox"/>	<input checked="" type="checkbox"/>	<input checked="" type="checkbox"/>	
Special tests		<input checked="" type="checkbox"/>	<input checked="" type="checkbox"/>	<input checked="" type="checkbox"/>	<input checked="" type="checkbox"/>	<input checked="" type="checkbox"/>	<input checked="" type="checkbox"/>	<input checked="" type="checkbox"/>	<input checked="" type="checkbox"/>	<input checked="" type="checkbox"/>	<input checked="" type="checkbox"/>	
Special documentation		<input checked="" type="checkbox"/>	<input checked="" type="checkbox"/>	<input checked="" type="checkbox"/>	<input checked="" type="checkbox"/>	<input checked="" type="checkbox"/>	<input checked="" type="checkbox"/>	<input checked="" type="checkbox"/>	<input checked="" type="checkbox"/>	<input checked="" type="checkbox"/>	<input checked="" type="checkbox"/>	
Special version		<input checked="" type="checkbox"/>	<input checked="" type="checkbox"/>	<input checked="" type="checkbox"/>	<input checked="" type="checkbox"/>	<input checked="" type="checkbox"/>	<input checked="" type="checkbox"/>	<input checked="" type="checkbox"/>	<input checked="" type="checkbox"/>	<input checked="" type="checkbox"/>	<input checked="" type="checkbox"/>	

✓ Available

☐ Standard version

– Not possible

× Not required

- This order code only determines the price of the version – additional plain text is required.

1) Voltage between 230 and 500 V.

2) Please ask your Siemens contact person for the exact cabinet dimensions.

3) Additional option included in the original option.

SINAMICS G180

SINAMICS G180 compact units and SINAMICS G180 cabinet systems

SINAMICS G180 cabinet systems

Dimensional drawings

Standard cabinet size for cabinet systems (option H81)

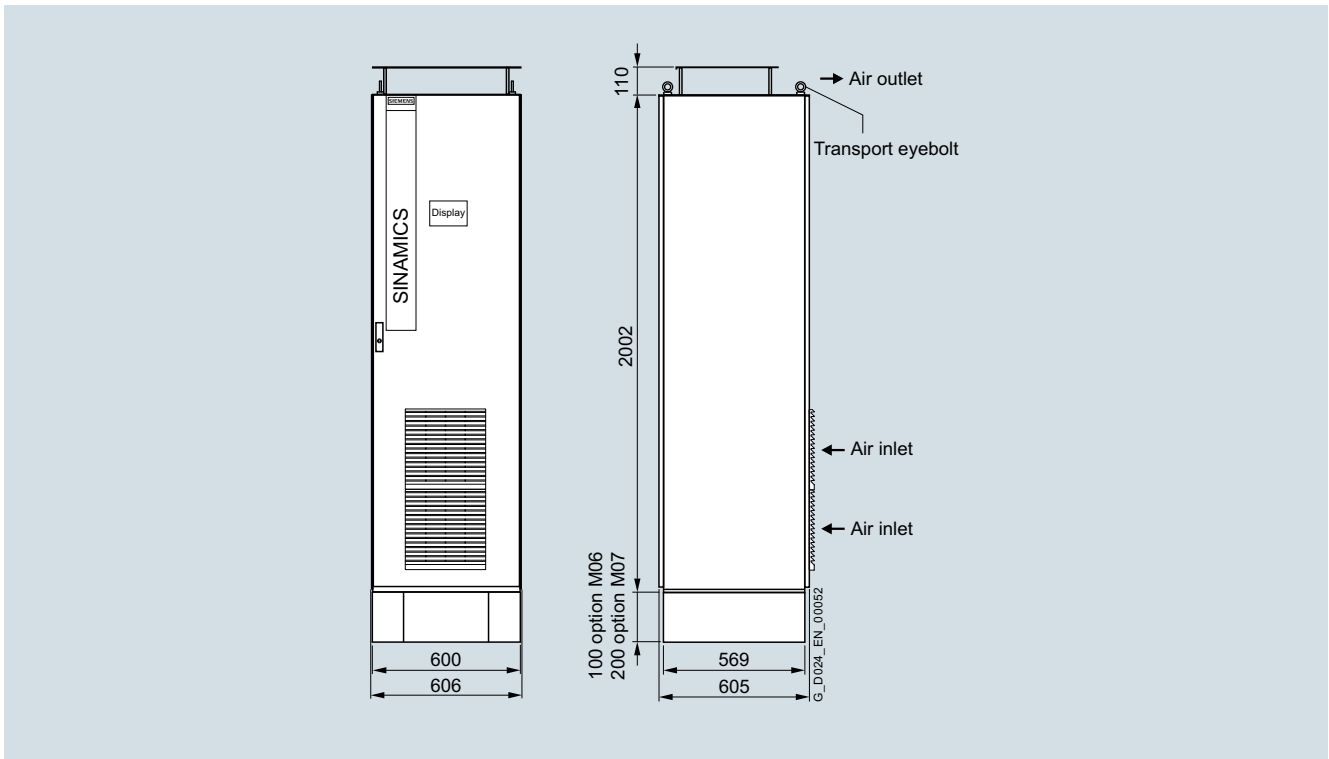

Dimensional drawing applies to standard cabinet systems (option H81) with converter without options. The cabinet dimensions might change if options are selected.

SINAMICS G180 cabinet units



3/2 SINAMICS G180 cabinet units air-cooled and liquid-cooled

3/2	<u>Overview</u>
3/3	<u>Technical data</u>
3/3	Standards for cabinet units
3/4	General technical data
3/6	400 V, 6-pulse
3/10	400 V, 12-pulse
3/14	500 V, 6-pulse
3/18	500 V, 12-pulse
3/22	690 V, 6-pulse
3/28	690 V, 12-pulse
3/38	690 V, 18-pulse
3/42	690 V, 24-pulse
3/48	<u>Selection and ordering data</u>
3/48	Article number code
3/49	Number code for converter type
3/50	<u>Options</u>

3/57 SINAMICS G180 cabinet units air-cooled

3/57	<u>Design</u>
3/57	<u>Selection and ordering data</u>
3/57	400 V, 6-pulse
3/57	400 V, 12-pulse
3/58	500 V, 6-pulse
3/58	500 V, 12-pulse
3/59	690 V, 6-pulse
3/60	690 V, 12-pulse
3/60	690 V, 18-pulse
3/61	690 V, 24-pulse
3/62	<u>Dimensional drawings</u>
3/62	Frame size SL2
3/63	Frame size SL21
3/64	Frame size SL3
3/65	Frame size SL4
3/66	Frame size SL5
3/67	Frame size SL6
3/68	Frame size SL7
3/69	Frame size SL8
3/70	Frame size SL9
3/71	Frame size SL10
3/72	Frame size SL11
3/73	Frame size SL12

3/74 SINAMICS G180 cabinet units liquid-cooled

3/74	<u>Design</u>
3/76	<u>Selection and ordering data</u>
3/76	400 V, 6-pulse
3/76	400 V, 12-pulse
3/77	500 V, 6-pulse
3/77	500 V, 12-pulse
3/78	690 V, 6-pulse
3/79	690 V, 12-pulse
3/79	690 V, 18-pulse
3/80	690 V, 24-pulse
3/81	<u>Dimensional drawings</u>
3/81	Frame size SW2
3/82	Frame size SW21
3/83	Frame size SW3
3/84	Frame size SW4
3/85	Frame size SW5
3/86	Frame size SW6
3/87	Frame size SW7
3/88	Frame size SW8
3/89	Frame size SW9
3/90	Frame size SW10

SINAMICS G180

SINAMICS G180 cabinet units

SINAMICS G180 cabinet units air-cooled and liquid-cooled

Overview



Example of SINAMICS G180 air-cooled converter cabinet unit

With its SINAMICS G180 cabinet units, Siemens is offering a drive system on which all line-side and motor-side components are integrated extremely compactly into a specially designed cabinet enclosure. This approach minimizes the effort and expense required to configure and install them.

SINAMICS G180 cabinet units are available in air-cooled and liquid-cooled versions.

SINAMICS G180 converter cabinet units are available for the following voltages and power ratings:

Rated line voltage	Power
400 V 3 AC	200 ... 630 kW ¹⁾
500 V 3 AC	250 ... 800 kW ¹⁾
690 V 3 AC	250 ... 6600 kW

Global use

SINAMICS G180 converter cabinet units are manufactured in compliance with relevant international standards and regulations, and are therefore suitable for global use (see technical data).

Air-cooled converter cabinet units

Air-cooled converter cabinet units are equipped with an ingeniously designed, highly efficient air guidance system which is quiet in operation.

Liquid-cooled converter cabinet units

These specially designed liquid-cooled versions of the SINAMICS G180 converter cabinet unit are extremely quiet in operation. Closed control cabinets in degree of protection IP54 or higher make these liquid-cooled converters suitable for applications in harsh environmental conditions.

The advantages of the liquid-cooled version as compared to the air-cooled version are as follows:

- Very low thermal loading of switch rooms
- Can be used almost anywhere, even in atmospheres harmful to machines, thanks to the IP55 degree of protection (IP54 with display in cabinet door)
- Reliable even at higher ambient temperatures up to 55° C thanks to optimal cooling effect
- Reduced noise emission through elimination of the cooling ventilation
- Improved efficiency
- The water-conveying parts of the cooling system are made of stainless steel (V2A), making it resistant to almost any water quality

¹⁾ Higher outputs available on request.

Technical data

The most important directives and standards are listed below. These are used as basis for the SINAMICS G180 cabinet units and they must be carefully observed to achieve an EMC-compliant configuration that is safe both functionally and in operation.

Standards for cabinet units

European directives	
2006/95/EC	Low-voltage directive: Legal guidelines of the EU member states concerning electrical equipment for use within specified voltage limits
2004/108/EC	EMC Directive: Legal guidelines of the EU member states for electromagnetic compatibility
International and European standards	
EN 954-1	Safety of machinery – Safety-related parts of control systems; Part 1: General design principles
EN ISO 13849-1	Safety of machinery – Safety-related parts of control systems; Part 1: General design principles (ISO 13849-1:2006) (replaced EN 954-1)
EN 60146-1-1	Semiconductor converters – General requirements and line-commutated converters Part 1-1: Specification of basic requirements
EN 60204-1	Electrical equipment of machines Part 1: General definitions
EN 60529	Degrees of protection provided by enclosures (IP code)
EN 61140	Protection against electric shock – Common aspects for installation and equipment
EN 61508-1	Functional safety of electrical/electronic/programmable electronic safety-related systems Part 1: General requirements
EN 61800-2	Adjustable speed electrical power drive systems, Part 2: General requirements – Rating specifications for low-voltage adjustable frequency AC power drive systems
EN 61800-3	Adjustable speed electrical power drive systems, Part 3: EMC requirements and specific test methods
EN 61800-5-1	Adjustable speed electrical power drive systems, Part 5-1: Safety requirements – Electrical, thermal and energy requirements
EN 61800-5-2	Adjustable speed electrical power drive systems, Part 5-2: Safety requirements – Functional safety (IEC 61800-5-2:2007)
North American standards	
UL508C ¹⁾	Power conversion equipment
Approvals	
TÜV NRTL US ¹⁾	Nationally Recognized Testing Laboratory

¹⁾ On request

SINAMICS G180

SINAMICS G180 cabinet units

SINAMICS G180 cabinet units air-cooled and liquid-cooled

Technical data (continued)

General technical data

Electrical data			
	Line voltages	Type of supply system	Output ranges
	230 ... 400 ... 415 V 3 AC, -15/+10 % 230 ... 500 V 3 AC, -15/+10 % 400 ... 690 V 3 AC, -15/+10 %	TN/TT system TN/TT/IT system TN/TT/IT system	200 ... 630 kW (at 400 V) 250 ... 800 kW (at 500 V) 250 ... 6000 kW (at 690 V)
Line frequency	47 ... 63 Hz		
Output frequency	0 ... 250 Hz		
Voltage rise in motor	Typ. 500 ... 1000 V/μs, but < 1500 V/μs		
Pulse number	6/12/18/24		
Typical line harmonics (<i>I</i>) in % of fundamental mode for the 5/7/11/13/17/19/23/25 harmonics, max. (6-pulse converter)	38/18/8/7/5/4/3/2		
Typical line harmonics (<i>I</i>) in % of fundamental mode for the 5/7/11/13/17/19/23/25 harmonics, max. (12-pulse converter)	1.5/1/6/4/0.5/0.2/2/2		
Typical line harmonics (<i>I</i>) in % of fundamental mode for the 5/7/11/13/17/19/23/25 harmonics, max. (18-pulse converter)	1/0.5/0.5/0.5/4/3.5/0.5/0.5		
Typical line harmonics (<i>I</i>) in % of fundamental mode for the 5/7/11/13/17/19/23/25 harmonics, max. (24-pulse converter)	1/0.5/0.5/0.5/0.5/0.2/2/2		
Typical line harmonics (<i>I</i>) in % of fundamental mode for the 5/7/11/13/17/19/23/25 harmonics max. with LHF filter	4.5/4.7/2.8/1.6/1.2/0.9/0.6/0.5		
Overvoltage category	III to EN 61800-5-1		
Short Circuit Current Rating (SCCR) according to UL508C (up to 600 V), in conjunction with the specified fuses or circuit breakers	20 times rated current, but at least 50 kA		
Control method	<ul style="list-style-type: none"> For motors: Field-oriented control (FOC) with sensor and approval for explosion-proof motors as well as vector control (SVC) with/without sensor (speed, process <i>speed</i> (<i>n</i>), torque, hoist¹⁾, line synchronization¹⁾) Motor-independent control of current or voltage (current, process <i>current</i> (<i>I</i>), voltage, process <i>voltage</i> (<i>U</i>)) 		
Fixed speeds	3 fixed speeds + 1 minimum speed, parameterizable		
Skipped speed ranges	2, parameterizable		
Setpoint resolution	13 bits digital with <i>n/f</i> setpoint, 12 bits digital with <i>U/I</i> torque setpoint, 9 bits + sign analog		
Braking operation	The oversaturation control system makes it possible to generate a braking torque of up to 50 % at low to mid-range speeds, and of up to 10 % at high speeds. If a higher braking torque is required, an optionally available braking module with appropriate braking resistor must be installed.		
Mechanical data			
Degree of protection	IP21 (higher degrees of protection optionally available) / with liquid cooling IP54		
Protection class	I acc. to EN 61800-5-1		
Touch protection	EN 50274 / BGV A3		
Type of cooling	Forced air cooling AF to EN 60146 / Coolant is water and a mixture of water and Antifrogen N with 45 % Antifrogen N		
Paint finish	RAL 7035; Rittal TS8 cabinet frame: With nano-ceramic and anodized coating, layer thickness approx. 10 to 20 μm; parts mounted on TS8 cabinet: With nano-ceramic and anodized coating, layer thickness approx. 10 to 20 μm, plus layer of hybrid polyester epoxy powder, thickness approx. 50 to 80 μm		
Cable entry	From below by means of profile clamp (from the top as option)		
Door hinge and opening angle	Right/130°		

¹⁾ On request

Technical data (continued)

General technical data (continued)

For liquid-cooled units only			
Coolant quality	See below under "Permissible substance values for the coolant"		
Permissible coolant temperature	+10 °C ... 28/30/35 °C (dependent on output, see technical data)		
Ambient conditions¹⁾	Storage ²⁾	Transport ²⁾	Operation
Ambient temperature	-25 ... <u>+70</u> °C Class 1K4 acc. to EN 60721-3-1	-25 ... +70 °C Down to -40 °C for 24h Class 2K3 acc. to EN 60721-3-2	Air: 0 ... 40 °C/ Water: 1 °C ... 40 °C (up to +40 °C see derating data)
Relative humidity (condensation not permissible)	5 ... <u>95</u> % Class 1K3 acc. to EN 60721-3-1	5 ... 95 % Class 2K3 acc. to EN 60721-3-2	5 ... 95 % Class 3K3 acc. to EN 60721-3-3
Environmental class/harmful chemical substances	Class 1C2 acc. to EN 60721-3-1	Class 2C2 acc. to EN 60721-3-2	Class 3C2 acc. to EN 60721-3-3
Organic/biological influences	Class 1B1 acc. to EN 60721-3-1	Class 2B1 acc. to EN 60721-3-2	Class 3B1 acc. to EN 60721-3-3
Pollution degree	2 acc. to EN 61800-5-1		
Installation altitude	Up to 1000 m above sea level without derating, > 1000 m see derating data		
Mechanical stability¹⁾	Storage ²⁾	Transport ²⁾	Operation
Vibratory load			
• Deflection	1.5 mm at <u>5</u> ... 9 Hz	3.5 mm at <u>5</u> ... 9 Hz	0.075 mm at 10 ... 57 Hz
• Acceleration	5 m/s ² at > 9 ... 200 Hz Class 1M2 to EN 60721-3-1	10 m/s ² at > 9 ... 200 Hz Class 2M2 to EN 60721-3-2	10 m/s ² at > 57 ... 150 Hz
Shock load			
• Acceleration	40 m/s ² at 22 ms Class 1M2 to EN 60721-3-1	100 m/s ² at 11 ms Class 2M2 to EN 60721-3-2	100 m/s ² at 11 ms Class 3M4 to EN 60721-3-3
Compliance with standards			
CE Label	Acc. to EMC Directive No. 2004/108/EC and Low-Voltage Directive No. 2006/95/EC		
Radio interference suppression	Complies with EMC guidelines defined in EN 61800-3 thanks to line filter which is integrated as standard with grounded supply system: <ul style="list-style-type: none"> • Category C3 for cabinet units in TN/TT system of the second environment (industrial area) • Category C4 for cabinet units in IT system of the second environment (industrial area) 		
Approvals	TÜV NRTL US ²⁾		

Deviations from the specified classes are underlined.

Permissible substance values for the coolant

The following table lists the permissible substance values for the cooling water (service water and demineralized water) for cooling the converter with an open standard cooling system without cooling unit.

	Permissible values for SINAMICS G180 cabinet units
Coolant temperature	+10 ... <u>+28/30/35</u> °C
pH value	7 ... 8
Total hardness	6 ... 20 °dH
Carbonate hardness	3 ... 10 dH
Total dissolved solids 105 °C	< 500 mg/l
Free carbon dioxide	< 1 mmol/l
Chlorides	< 150 mg/l
Sulfates	500 mg/l
Nitrates	< 10 mg/l
Nitrites	0 mg/l
Phosphates	< 0.5 mg/l
Ammonium NH ₄	< 0.5 mg/l
Ammoniac	0 mg/l
Silicon (SiO ₂ crystalline)	< 10 mg/l
Free CO ₂ (p value)	< 15 mg/l
Iron	< 0.2 mg/l
Hydrogen sulfide	< 1 mg/l
Suspended solids < 50 µm	< 10 mg/l
Conductivity	< 3000 µS/cm
Oxygen	8 ... 12 mg/l

¹⁾ Higher standards on request

²⁾ In transport packaging

Cooling water additives for the closed converter cooling system with cooling unit

We recommend the agent "Antifrogen N" supplied by Clariant as a cooling water additive.

The appropriate level of anti-freeze protection can be provided by choosing the correct mixing ratio. A minimum concentration of 20 % by volume provides anti-freeze protection down to -10 °C. An Antifrogen/water mixing ratio of 1:2 provides anti-freeze protection down to -20 °C.

Unpolluted water mixed with a minimum concentration of 20 % by volume of Antifrogen N prevents the growth of micro-organisms and the formation of algae.

SINAMICS G180

SINAMICS G180 cabinet units

SINAMICS G180 cabinet units air-cooled and liquid-cooled

Technical data (continued)

400 V, 6-pulse

Line voltage, supply system type		400, 415 V 3 AC TT/TN				
SINAMICS G180 cabinet units – air-cooled		6SE0180-1BA33-7■A7	6SE0180-1BA34-6■A7	6SE0180-1BA36-3■A7	6SE0180-1BA37-3■A7	6SE0180-1BA38-8■A7
<i>Converter type</i> (air-cooled)		2T3A-87401-200	2T3A-87401-250	2T3A-87401-315	2T3A-87401-400	2T3A-87401-500
SINAMICS G180 cabinet units – liquid-cooled		6SE0170-1BA33-7■A7	6SE0170-1BA34-6■A7	6SE0170-1BA36-3■A7	6SE0170-1BA37-3■A7	6SE0170-1BA38-8■A7
<i>Converter type</i> (liquid-cooled)		2T6A-77401-200	2T6A-77401-250	2T6A-77401-315	2T6A-77401-400	2T6A-77401-500
Electrical data at motor end						
Type rating¹⁾						
• at 50 Hz 400 V	kW	200	250	315	400	500
• at 50 Hz 400 V	hp	268	335	422	536	671
Output voltage²⁾	V	0 ... 0.98 × V _{line}	0 ... 0.98 × V _{line}	0 ... 0.98 × V _{line}	0 ... 0.98 × V _{line}	0 ... 0.98 × V _{line}
Output current						
• Continuous current	A	380	460	630	740	910
• Short-time current (60 s every 10 minutes) max.	A	470	560	700	900	1110
Overload capability (60 s every 10 minutes) max.	%	24	22	11	22	22
Output power	kVA	263	319	436	513	630
Output frequency, max.	Hz	250	250	250	120	120
Rated clock cycle	kHz	3	3	3	2.4	2.4
adjustable from	kHz	2 ... 5	2 ... 5	2 ... 5	1.5 ... 3.7	1.5 ... 3.7
Power loss³⁾	kW	5.6	6.42	8.4	11.9	14.9
Rated efficiency	%	97.4	97.6	97.5	97.2	97.2
Electrical data at line end						
Connected load	kVA	249	300	403	476	603
Rated input voltage	V	400	400	400	400	400
Input current						
• Continuous line current	A	360	433	582	687	871
• Short-time line current (60 s) max.	A	445	527	647	836	1062
Line fuse (provided by customer)	gL (A)	400	500	630	800	900
λ_{line}		0.931	0.928	0.943	0.942	0.946
cos ϕ_{line}		1	1	1	1	1
Radio interference suppression acc. to EN 61800-3		C3 (class A filter)	C3 (class A filter)	C3 (class A filter)	C3 (class A filter)	C3 (class A filter)
Mechanical data for air-cooled cabinet units						
Frame size (dimensional drawing classification)		SL2	SL2	SL2	SL21	SL3
Sound pressure level L_{pA} (1 m) at 50/60 Hz	dB	70	70	73	75	75
Standard converter dimensions						
• Width	mm	806	806	806	1206	1606
• Height ⁴⁾	mm	2112	2112	2112	2112	2112
• Depth	mm	605	605	605	605	605
Coolant requirements	m ³ /h	1900	1900	1900	2250	3800
Weight, approx.	kg	490	510	530	780	890
Mechanical data for liquid-cooled cabinet units						
Frame size (dimensional drawing classification)		SW2	SW2	SW2	SW21	SW3
Sound pressure level L_{pA} (1 m) at 50/60 Hz	dB	68	68	71	73	73
Standard converter dimensions⁶⁾						
• Width	mm	806	806	806	1206	1806
• Height	mm	2202	2202	2202	2202	2202
• Depth	mm	605	605	605	605	605
Coolant requirements	l/h	1200	1200	1200	1200	2000
Min. coolant pressure	bar	2.5	2.5	2.5	2.5	2.5
Max. coolant pressure	bar	6	6	6	6	6
Coolant test pressure	bar	10	10	10	10	10
Coolant pressure loss	bar	1.9	1.9	1.9	1.9	1.9
Min. coolant temperature	°C	10	10	10	10	10
Max. coolant temperature	°C	35	35	35	30	35
Weight, approx.	kg	490	510	530	860	920

For footnotes, see next page.

SINAMICS G180

SINAMICS G180 cabinet units

SINAMICS G180 cabinet units
air-cooled and liquid-cooled

Technical data (continued)

Line voltage, supply system type		400, 415 V 3 AC TT/TN				
SINAMICS G180 cabinet units – air-cooled		6SE0180-1BA33-7■A7	6SE0180-1BA34-6■A7	6SE0180-1BA36-3■A7	6SE0180-1BA37-3■A7	6SE0180-1BA38-8■A7
<i>Converter type</i> (air-cooled)		2T3A-87401-200	2T3A-87401-250	2T3A-87401-315	2T3A-87401-400	2T3A-87401-500
SINAMICS G180 cabinet units – liquid-cooled		6SE0170-1BA33-7■A7	6SE0170-1BA34-6■A7	6SE0170-1BA36-3■A7	6SE0170-1BA37-3■A7	6SE0170-1BA38-8■A7
<i>Converter type</i> (liquid-cooled)		2T6A-77401-200	2T6A-77401-250	2T6A-77401-315	2T6A-77401-400	2T6A-77401-500
General mechanical data						
Max. cable length between converter and motor with standard insulation (shielded)		m	300 ⁵⁾	300 ⁵⁾	300 ⁵⁾	300 ⁵⁾
Line/load connection						
L1, L2, L3/U2, V2, W2						
For connection cross-sections, see "Cable cross-sections and connections" in section "Configuring instructions"						
Approvals, according to			NRTL ⁶⁾	NRTL ⁶⁾	NRTL ⁶⁾	NRTL ⁶⁾

1) Rated power of a typical 2- to 6-pole standard motor.
 2) Typical output voltage dependent on filter and unit type.
 3) Maximum power loss with continuous motor current.
 4) With IP21 protective top cover (110 mm).

5) Option L10 included (strengthened dv/dt filter; strengthened filter is integrated in unit).
 6) On request.

SINAMICS G180

SINAMICS G180 cabinet units

SINAMICS G180 cabinet units air-cooled and liquid-cooled

Technical data (continued)

400 V, 6-pulse (continued)

Line voltage, supply system type	400, 415 V 3 AC TT/TN		
SINAMICS G180 cabinet units – air-cooled	6SE0180-1BA41-0■A7	6SE0180-1BA41-1■A7	
<i>Converter type</i> (air-cooled)	2T3A-87401-560	2T3A-87401-630	
SINAMICS G180 cabinet units – liquid-cooled	6SE0170-1BA41-0■A7	6SE0170-1BA41-1■A7	
<i>Converter type</i> (liquid-cooled)	2T6A-77401-560	2T6A-77401-630	
Electrical data at motor end			
Type rating¹⁾			
• at 50 Hz 400 V	kW	560	630
• at 50 Hz 400 V	hp	751	845
Output voltage²⁾	V	0 ... 0.98 × V _{line}	0 ... 0.98 × V _{line}
Output current			
• Continuous current	A	1020	1140
• Short-time current (60 s every 10 minutes) max.	A	1230	1370
Overload capability (60 s every 10 minutes) max.	%	21	20
Output power	kVA	707	790
Output frequency, max.	Hz	120	120
Rated clock cycle	kHz	2.4	2.4
adjustable from	kHz	1.5 ... 3.7	1.5 ... 3.7
Power loss³⁾	kW	16.7	18.1
Rated efficiency	%	97.2	97.3
Electrical data at line end			
Connected load	kVA	676	761
Rated input voltage	V	400	400
Input current			
• Continuous line current	A	975	1098
• Short-time line current (60 s) max.	A	1176	1320
Line fuse (provided by customer)	gL (A)	1000	1250
λ_{line}		0.947	0.95
Cos ϕ_{line}		1	1
Radio interference suppression acc. to EN 61800-3		C3 (class A filter)	C3 (class A filter)
Mechanical data for air-cooled cabinet units			
Frame size (dimensional drawing classification)	SL3	SL3	
Sound pressure level L_{pA} (1 m) at 50/60 Hz	dB	75	75
Standard converter dimensions			
• Width	mm	1606	1606
• Height ⁴⁾	mm	2112	2112
• Depth	mm	605	605
Coolant requirements	m ³ /h	3200	3800
Weight, approx.	kg	900	930
Mechanical data for liquid-cooled cabinet units			
Frame size (dimensional drawing classification)	SW3	SW3	
Sound pressure level L_{pA} (1 m) at 50/60 Hz	dB	73	73
Standard converter dimensions⁶⁾			
• Width	mm	1806	1806
• Height	mm	2202	2202
• Depth	mm	605	605
Coolant requirements	l/h	2000	2000
Min. coolant pressure	bar	2.5	2.5
Max. coolant pressure	bar	6	6
Coolant test pressure	bar	10	10
Coolant pressure loss	bar	1.9	1.9
Min. coolant temperature	°C	10	10
Max. coolant temperature	°C	35	35
Weight, approx.	kg	930	960

For footnotes, see next page.

SINAMICS G180

SINAMICS G180 cabinet units

SINAMICS G180 cabinet units
air-cooled and liquid-cooled

Technical data (continued)

Line voltage, supply system type	400, 415 V 3 AC TT/TN		
SINAMICS G180 cabinet units – air-cooled	6SE0180-1BA41-0■A7	6SE0180-1BA41-1■A7	
<i>Converter type</i> (air-cooled)	2T3A-87401-560	2T3A-87401-630	
SINAMICS G180 cabinet units – liquid-cooled	6SE0170-1BA41-0■A7	6SE0170-1BA41-1■A7	
<i>Converter type</i> (liquid-cooled)	2T6A-77401-560	2T6A-77401-630	
General mechanical data			
Max. cable length between converter and motor with standard insulation (shielded)	m	300 ⁵⁾	300 ⁵⁾
Line/load connection			
L1, L2, L3/U2, V2, W2 For connection cross-sections, see "Cable cross-sections and connections" in section "Configuring instructions"			
Approvals, according to	NRTL ⁶⁾	NRTL ⁶⁾	

3

1) Rated power of a typical 2- to 6-pole standard motor.
 2) Typical output voltage dependent on filter and unit type.
 3) Maximum power loss with continuous motor current.
 4) With IP21 protective top cover (110 mm).

5) Option L10 included (strengthened dv/dt filter; strengthened filter is integrated in unit).
 6) On request.

SINAMICS G180

SINAMICS G180 cabinet units

SINAMICS G180 cabinet units air-cooled and liquid-cooled

Technical data (continued)

400 V, 12-pulse

Line voltage, supply system type		400, 415 V 3 AC IT				
SINAMICS G180 cabinet units – air-cooled		6SE0180-2BA33-7■A7	6SE0180-2BA34-6■A7	6SE0180-2BA36-3■A7	6SE0180-2BA37-3■A7	6SE0180-2BA38-8■A7
<i>Converter type</i> (air-cooled)		2T3F-87401-200	2T3F-87401-250	2T3F-87401-315	2T3F-87401-400	2T3F-87401-500
SINAMICS G180 cabinet units – liquid-cooled		6SE0170-2BA33-7■A7	6SE0170-2BA34-6■A7	6SE0170-2BA36-3■A7	6SE0170-2BA37-3■A7	6SE0170-2BA38-8■A7
<i>Converter type</i> (liquid-cooled)		2T6F-77401-200	2T6F-77401-250	2T6F-77401-315	2T6F-77401-400	2T6F-77401-500
Electrical data at motor end						
Type rating¹⁾						
• at 50 Hz 400 V	kW	200	250	315	400	500
• at 50 Hz 400 V	hp	268	335	422	536	671
Output voltage²⁾	V	0 ... 0.98 × V _{line}	0 ... 0.98 × V _{line}	0 ... 0.98 × V _{line}	0 ... 0.98 × V _{line}	0 ... 0.98 × V _{line}
Output current						
• Continuous current	A	380	460	630	740	910
• Short-time current (60 s every 10 minutes) max.	A	470	560	700	900	1110
Overload capability (60 s every 10 minutes) max.	%	24	22	11	22	22
Output power	kVA	263	319	436	513	630
Output frequency, max.	Hz	250	250	250	120	120
Rated clock cycle	kHz	3	3	3	2.4	2.4
adjustable from	kHz	2 ... 5	2 ... 5	2 ... 5	1.5 ... 3.7	1.5 ... 3.7
Power loss³⁾	kW	5.6	6.42	8.4	11.9	14.9
Rated efficiency	%	97.4	97.6	97.5	97.2	97.2
Electrical data at line end						
Connected load	kVA	249	301	405	477	604
Rated input voltage	V	400	400	400	400	400
Input current						
• Continuous line current	A	180	217	292	344	436
• Short-time line current (60 s) max.	A	223	264	324	418	532
Line fuse (provided by customer)	gL (A)	200	250	400	400	500
λ_{line}		0.994	0.994	0.994	0.996	0.996
cos ϕ_{line}		1	1	1	1	1
Radio interference suppression acc. to EN 61800-3		C3 (class A filter)	C3 (class A filter)	C3 (class A filter)	C3 (class A filter)	C3 (class A filter)
Mechanical data for air-cooled cabinet units						
Frame size (dimensional drawing classification)		SL5	SL5	SL5	SL5	SL6
Sound pressure level L_{pA} (1 m) at 50/60 Hz	dB	70	70	73	75	75
Standard converter dimensions						
• Width	mm	1406	1406	1406	1406	1806
• Height ⁴⁾	mm	2112	2112	2112	2112	2112
• Depth	mm	605	605	605	605	605
Coolant requirements	m ³ /h	1900	1900	1900	2250	3800
Weight, approx.	kg	690	710	730	810	920
Mechanical data for liquid-cooled cabinet units						
Frame size (dimensional drawing classification)		SW5	SW5	SW5	SW5	SW6
Sound pressure level L_{pA} (1 m) at 50/60 Hz	dB	68	68	71	73	73
Standard converter dimensions						
• Width	mm	1406	1406	1406	1406	2006
• Height	mm	2202	2202	2202	2202	2202
• Depth	mm	605	605	605	605	605
Coolant requirements	l/h	1200	1200	1200	1200	2000
Min. coolant pressure	bar	2.5	2.5	2.5	2.5	2.5
Max. coolant pressure	bar	6	6	6	6	6
Coolant test pressure	bar	10	10	10	10	10
Coolant pressure loss	bar	1.9	1.9	1.9	1.9	1.9
Min. coolant temperature	°C	10	10	10	10	10
Max. coolant temperature	°C	35	35	35	30	35
Weight, approx.	kg	690	710	730	810	950

For footnotes, see next page.

SINAMICS G180

SINAMICS G180 cabinet units

SINAMICS G180 cabinet units
air-cooled and liquid-cooled

Technical data (continued)

Line voltage, supply system type	400, 415 V 3 AC IT				
SINAMICS G180 cabinet units – air-cooled	6SE0180-2BA33-7■A7	6SE0180-2BA34-6■A7	6SE0180-2BA36-3■A7	6SE0180-2BA37-3■A7	6SE0180-2BA38-8■A7
<i>Converter type</i> (air-cooled)	2T3F-87401-200	2T3F-87401-250	2T3F-87401-315	2T3F-87401-400	2T3F-87401-500
SINAMICS G180 cabinet units – liquid-cooled	6SE0170-2BA33-7■A7	6SE0170-2BA34-6■A7	6SE0170-2BA36-3■A7	6SE0170-2BA37-3■A7	6SE0170-2BA38-8■A7
<i>Converter type</i> (liquid-cooled)	2T6F-77401-200	2T6F-77401-250	2T6F-77401-315	2T6F-77401-400	2T6F-77401-500
General mechanical data					
Max. cable length between converter and motor with standard insulation (shielded)	m	300 ⁵⁾	300 ⁵⁾	300 ⁵⁾	300 ⁵⁾
Line/load connection					
L1, L2, L3/U2, V2, W2					
For connection cross-sections, see "Cable cross-sections and connections" in section "Configuring instructions"					
Approvals, according to		NRTL ⁶⁾	NRTL ⁶⁾	NRTL ⁶⁾	NRTL ⁶⁾

1) Rated power of a typical 2- to 6-pole standard motor.
 2) Typical output voltage dependent on filter and unit type.
 3) Maximum power loss with continuous motor current.
 4) With IP21 protective top cover (110 mm).

5) Option L10 included (strengthened dv/dt filter; strengthened filter is integrated in unit).
 6) On request.

SINAMICS G180

SINAMICS G180 cabinet units

SINAMICS G180 cabinet units air-cooled and liquid-cooled

Technical data (continued)

400 V, 12-pulse (continued)

Line voltage, supply system type		400, 415 V 3 AC IT	
SINAMICS G180 cabinet units – air-cooled		6SE0180-2BA41-0■A7	6SE0180-2BA41-1■A7
<i>Converter type</i> (air-cooled)		2T3F-87401-560	2T3F-87401-630
SINAMICS G180 cabinet units – liquid-cooled		6SE0170-2BA41-0■A7	6SE0170-2BA41-1■A7
<i>Converter type</i> (liquid-cooled)		2T6F-77401-560	2T6F-77401-630
Electrical data at motor end			
Type rating¹⁾			
• at 50 Hz 400 V	kW	560	630
• at 50 Hz 400 V	hp	751	845
Output voltage²⁾	V	0 ... 0.98 × V _{line}	0 ... 0.98 × V _{line}
Output current			
• Continuous current	A	1020	1140
• Short-time current (60 s every 10 minutes) max.	A	1230	1370
Overload capability (60 s every 10 minutes) max.	%	21	20
Output power	kVA	707	790
Output frequency, max.	Hz	120	120
Rated clock cycle	kHz	2.4	2.4
adjustable from	kHz	1.5 ... 3.7	1.5 ... 3.7
Power loss³⁾	kW	16.7	18.1
Rated efficiency	%	97.2	97.3
Electrical data at line end			
Connected load	kVA	676	762
Rated input voltage	V	400	400
Input current			
• Continuous line current	A	488	550
• Short-time line current (60 s) max.	A	588	661
Line fuse (provided by customer)	gL (A)	630	630
λ_{line}		0.996	0.997
cos ϕ_{line}		1	1
Radio interference suppression acc. to EN 61800-3		C4	C4
Mechanical data for air-cooled cabinet units			
Frame size (dimensional drawing classification)		SL6	SL6
Sound pressure level L_{pA} (1 m) at 50/60 Hz	dB	75	75
Standard converter dimensions			
• Width	mm	1806	1806
• Height ⁴⁾	mm	2112	2112
• Depth	mm	605	605
Coolant requirements	m ³ /h	3200	3800
Weight, approx.	kg	930	960
Mechanical data for liquid-cooled cabinet units			
Frame size (dimensional drawing classification)		SW6	SW6
Sound pressure level L_{pA} (1 m) at 50/60 Hz	dB	73	73
Standard converter dimensions			
• Width	mm	2006	2006
• Height	mm	2202	2202
• Depth	mm	605	605
Coolant requirements	l/h	2000	2000
Min. coolant pressure	bar	2.5	2.5
Max. coolant pressure	bar	6	6
Coolant test pressure	bar	10	10
Coolant pressure loss	bar	1.9	1.9
Min. coolant temperature	°C	10	10
Max. coolant temperature	°C	35	35
Weight, approx.	kg	960	990

For footnotes, see next page.

SINAMICS G180

SINAMICS G180 cabinet units

SINAMICS G180 cabinet units
air-cooled and liquid-cooled

Technical data (continued)

Line voltage, supply system type	400, 415 V 3 AC IT		
SINAMICS G180 cabinet units – air-cooled	6SE0180-2BA41-0■A7	6SE0180-2BA41-1■A7	
<i>Converter type</i> (air-cooled)	2T3F-87401-560	2T3F-87401-630	
SINAMICS G180 cabinet units – liquid-cooled	6SE0170-2BA41-0■A7	6SE0170-2BA41-1■A7	
<i>Converter type</i> (liquid-cooled)	2T6F-77401-560	2T6F-77401-630	
General mechanical data			
Max. cable length between converter and motor with standard insulation (shielded)	m	300 ⁵⁾	300 ⁵⁾
Line/load connection			
L1, L2, L3/U2, V2, W2 For connection cross-sections, see "Cable cross-sections and connections" in section "Configuring instructions"			
Approvals, according to	NRTL ⁶⁾	NRTL ⁶⁾	

3

1) Rated power of a typical 2- to 6-pole standard motor.
 2) Typical output voltage dependent on filter and unit type.
 3) Maximum power loss with continuous motor current.
 4) With IP21 protective top cover (110 mm).

5) Option L10 included (strengthened dv/dt filter; strengthened filter is integrated in unit).
 6) On request.

SINAMICS G180

SINAMICS G180 cabinet units

SINAMICS G180 cabinet units air-cooled and liquid-cooled

Technical data (continued)

500 V, 6-pulse

Line voltage, supply system type		400, 415, 460, 500 V 3 AC IT/TT/TN				
SINAMICS G180 cabinet units – air-cooled		6SE0180-1BD33-7■A7	6SE0180-1BD34-6■A7	6SE0180-1BD36-3■A7	6SE0180-1BD37-3■A7	6SE0180-1BD38-2■A7
<i>Converter type</i> (air-cooled)		2T3A-87501-250	2T3A-87501-315	2T3A-87501-400	2T3A-87501-500	2T3A-87501-560
SINAMICS G180 cabinet units – liquid-cooled		6SE0170-1BD33-7■A7	6SE0170-1BD34-6■A7	6SE0170-1BD36-3■A7	6SE0170-1BD37-3■A7	6SE0170-1BD38-2■A7
<i>Converter type</i> (liquid-cooled)		2T6A-77501-250	2T6A-77501-315	2T6A-77501-400	2T6A-77501-500	2T6A-77501-560
Electrical data at motor end						
Type rating¹⁾						
• at 50 Hz 500 V	kW	250	315	400	500	560
• at 60 Hz 460 V	hp	309	389	494	617	691
Output voltage²⁾	V	0 ... 0.98 × V _{line}	0 ... 0.98 × V _{line}	0 ... 0.98 × V _{line}	0 ... 0.98 × V _{line}	0 ... 0.98 × V _{line}
Output current						
• Continuous current	A	370	460	640	730	820
• Short-time current (60 s every 10 minutes) max.	A	450	560	700	900	980
Overload capability (60 s every 10 minutes) max.	%	22	22	9	23	20
Output power	kVA	320	398	554	632	710
Output frequency, max.	Hz	250	250	250	120	120
Rated clock cycle	kHz	3	3	2.4	2.4	2.4
adjustable from	kHz	2 ... 5	2 ... 5	1.5 ... 3.7	1.5 ... 3.7	1.5 ... 3.7
Power loss³⁾	kW	6.15	7.39	9.37	12.8	13.7
Rated efficiency	%	97.7	97.8	97.8	97.6	97.7
Electrical data at line end						
Connected load	kVA	303	378	515	606	678
Rated input voltage	V	500	500	500	500	500
Input current						
• Continuous line current	A	350	437	595	700	783
• Short-time line current (60 s) max.	A	426	532	651	863	936
Line fuse (provided by customer)	gL (A)	400	500	630	800	800
λ_{line}		0.918	0.916	0.936	0.942	0.944
cos ϕ_{line}		1	1	1	1	1
Radio interference suppression acc. to EN 61800-3⁴⁾		C3 (class A filter)	C3 (class A filter)	C3 (class A filter)	C3 (class A filter)	C3 (class A filter)
Mechanical data for air-cooled cabinet units						
Frame size (dimensional drawing classification)		SL2	SL2	SL2	SL21	SL3
Sound pressure level L_{pA} (1 m) at 50/60 Hz	dB	70	73	73	75	75
Standard converter dimensions						
• Width	mm	806	806	806	1206	1606
• Height ⁵⁾	mm	2112	2112	2112	2112	2112
• Depth	mm	605	605	605	605	605
Coolant requirements	m ³ /h	1900	1900	1900	2250	3200
Weight, approx.	kg	490	510	530	780	890
Mechanical data for liquid-cooled cabinet units						
Frame size (dimensional drawing classification)		SW2	SW2	SW2	SW21	SW3
Sound pressure level L_{pA} (1 m) at 50/60 Hz	dB	68	71	71	73	73
Standard converter dimensions						
• Width	mm	806	806	806	1206	1806
• Height	mm	2202	2202	2202	2202	2202
• Depth	mm	605	605	605	605	605
Coolant requirements	l/h	1200	1200	1200	1200	2000
Min. coolant pressure	bar	2.5	2.5	2.5	2.5	2.5
Max. coolant pressure	bar	6	6	6	6	6
Coolant test pressure	bar	10	10	10	10	10
Coolant pressure loss	bar	1.9	1.9	1.9	1.9	1.9
Min. coolant temperature	°C	10	10	10	10	10
Max. coolant temperature	°C	35	35	35	30	35
Weight, approx.	kg	490	510	530	850	920

For footnotes, see next page.

SINAMICS G180

SINAMICS G180 cabinet units

SINAMICS G180 cabinet units
air-cooled and liquid-cooled

Technical data (continued)

Line voltage, supply system type	400, 415, 460, 500 V 3 AC IT/TT/TN				
SINAMICS G180 cabinet units – air-cooled	6SE0180-1BD33-7■A7	6SE0180-1BD34-6■A7	6SE0180-1BD36-3■A7	6SE0180-1BD37-3■A7	6SE0180-1BD38-2■A7
<i>Converter type</i> (air-cooled)	<i>2T3A-87501-250</i>	<i>2T3A-87501-315</i>	<i>2T3A-87501-400</i>	<i>2T3A-87501-500</i>	<i>2T3A-87501-560</i>
SINAMICS G180 cabinet units – liquid-cooled	6SE0170-1BD33-7■A7	6SE0170-1BD34-6■A7	6SE0170-1BD36-3■A7	6SE0170-1BD37-3■A7	6SE0170-1BD38-2■A7
<i>Converter type</i> (liquid-cooled)	<i>2T6A-77501-250</i>	<i>2T6A-77501-315</i>	<i>2T6A-77501-400</i>	<i>2T6A-77501-500</i>	<i>2T6A-77501-560</i>
General mechanical data					
Max. cable length between converter and motor with standard insulation (shielded)	m	250 ⁶⁾	250 ⁶⁾	250 ⁶⁾	250 ⁶⁾
Line/load connection					
L1, L2, L3/U2, V2, W2					
For connection cross-sections, see "Cable cross-sections and connections" in section "Configuring instructions"					
Approvals, according to		NRTL ⁷⁾	NRTL ⁷⁾	NRTL ⁷⁾	NRTL ⁷⁾

3

¹⁾ Rated power of a typical 2- to 6-pole standard motor.

²⁾ Typical output voltage dependent on filter and unit type.

³⁾ Maximum power loss with continuous motor current.

⁴⁾ EMC filter not required for IT system, in which case RI suppression category C4.

⁵⁾ With IP21 protective top cover (110 mm).

⁶⁾ Option L10 included (strengthened dv/dt filter; strengthened filter is integrated in unit).

⁷⁾ On request.

SINAMICS G180

SINAMICS G180 cabinet units

SINAMICS G180 cabinet units air-cooled and liquid-cooled

Technical data (continued)

500 V, 6-pulse (continued)

Line voltage, supply system type		400, 415, 460, 500 V 3 AC IT/TT/TN		
SINAMICS G180 cabinet units – air-cooled		6SE0180-1BD38-8■A7	6SE0180-1BD41-0■A7	6SE0180-1BD41-1■A7
<i>Converter type</i> (air-cooled)		2T3A-87501-630	2T3A-87501-710	2T3A-87501-800
SINAMICS G180 cabinet units – liquid-cooled		6SE0170-1BD38-8■A7	6SE0170-1BD41-0■A7	6SE0170-1BD41-1■A7
<i>Converter type</i> (liquid-cooled)		2T6A-77501-630	2T6A-77501-710	2T6A-77501-800
Electrical data at motor end				
Type rating¹⁾				
• at 50 Hz 500 V	kW	630	710	800
• at 60 Hz 460 V	hp	777	876	987
Output voltage²⁾	V	0 ... 0.98 × V _{line}	0 ... 0.98 × V _{line}	0 ... 0.98 × V _{line}
Output current				
• Continuous current	A	920	1030	1150
• Short-time current (60 s every 10 minutes) max.	A	1100	1230	1380
Overload capability (60 s every 10 minutes) max.	%	20	19	20
Output power	kVA	797	892	996
Output frequency, max.	Hz	120	120	120
Rated clock cycle	kHz	2.4	2.4	2.4
adjustable from	kHz	1.5 ... 3.7	1.5 ... 3.7	1.5 ... 3.7
Power loss³⁾	kW	15.4	18.1	20.3
Rated efficiency	%	97.7	97.6	97.6
Electrical data at line end				
Connected load	kVA	767	848	944
Rated input voltage	V	500	500	500
Input current				
• Continuous line current	A	886	979	1090
• Short-time line current (60 s) max.	A	1059	1169	1308
Line fuse (provided by customer)	gL (A)	900	1000	1250
λ_{line}		0.946	0.948	0.95
Cos ϕ_{line}		1	1	1
Radio interference suppression acc. to EN 61800-3⁴⁾		C3 (class A filter)	C3 (class A filter)	C3 (class A filter)
Mechanical data for air-cooled cabinet units				
Frame size (dimensional drawing classification)		SL3	SL3	SL3
Sound pressure level L_{pA} (1 m) at 50/60 Hz	dB	75	75	75
Standard converter dimensions				
• Width	mm	1606	1606	1606
• Height ⁵⁾	mm	2112	2112	2112
• Depth	mm	605	605	605
Coolant requirements	m ³ /h	3800	3200	3800
Weight, approx.	kg	900	930	980
Mechanical data for liquid-cooled cabinet units				
Frame size (dimensional drawing classification)		SW3	SW3	SW3
Sound pressure level L_{pA} (1 m) at 50/60 Hz	dB	73	73	73
Standard converter dimensions				
• Width	mm	1806	1806	1806
• Height	mm	2202	2202	2202
• Depth	mm	605	605	605
Coolant requirements	l/h	2000	2000	2000
Min. coolant pressure	bar	2.5	2.5	2.5
Max. coolant pressure	bar	6	6	6
Coolant test pressure	bar	10	10	10
Coolant pressure loss	bar	1.9	1.9	1.9
Min. coolant temperature	°C	10	10	10
Max. coolant temperature	°C	35	35	30
Weight, approx.	kg	930	960	1010

For footnotes, see next page.

SINAMICS G180

SINAMICS G180 cabinet units

SINAMICS G180 cabinet units
air-cooled and liquid-cooled

Technical data (continued)

Line voltage, supply system type	400, 415, 460, 500 V 3 AC IT/TT/TN			
SINAMICS G180 cabinet units – air-cooled	6SE0180-1BD38-8■A7	6SE0180-1BD41-0■A7	6SE0180-1BD41-1■A7	
<i>Converter type</i> (air-cooled)	<i>2T3A-87501-630</i>	<i>2T3A-87501-710</i>	<i>2T3A-87501-800</i>	
SINAMICS G180 cabinet units – liquid-cooled	6SE0170-1BD38-8■A7	6SE0170-1BD41-0■A7	6SE0170-1BD41-1■A7	
<i>Converter type</i> (liquid-cooled)	<i>2T6A-77501-630</i>	<i>2T6A-77501-710</i>	<i>2T6A-77501-800</i>	
General mechanical data				
Max. cable length between converter and motor with standard insulation (shielded)	m	250 ⁶⁾	250 ⁶⁾	250 ⁶⁾
Line/load connection				
L1, L2, L3/U2, V2, W2 For connection cross-sections, see "Cable cross-sections and connections" in section "Configuring instructions"				
Approvals, according to		NRTL ⁷⁾	NRTL ⁷⁾	NRTL ⁷⁾

3

¹⁾ Rated power of a typical 2- to 6-pole standard motor.

²⁾ Typical output voltage dependent on filter and unit type.

³⁾ Maximum power loss with continuous motor current.

⁴⁾ EMC filter not required for IT system, in which case RI suppression category C4.

⁵⁾ With IP21 protective top cover (110 mm).

⁶⁾ Option L10 included (strengthened dv/dt filter; strengthened filter is integrated in unit).

⁷⁾ On request.

SINAMICS G180

SINAMICS G180 cabinet units

SINAMICS G180 cabinet units air-cooled and liquid-cooled

Technical data (continued)

500 V, 12-pulse

Line voltage, supply system type		2 × 400, 415, 460, 500 V 3 AC IT				
SINAMICS G180 cabinet units – air-cooled		6SE0180-2BD33-7■A7	6SE0180-2BD34-6■A7	6SE0180-2BD36-3■A7	6SE0180-2BD37-3■A7	6SE0180-2BD38-2■A7
<i>Converter type</i> (air-cooled)		2T3F-87501-250	2T3F-87501-315	2T3F-87501-400	2T3F-87501-500	2T3F-87501-560
SINAMICS G180 cabinet units – liquid-cooled		6SE0170-2BD33-7■A7	6SE0170-2BD34-6■A7	6SE0170-2BD36-3■A7	6SE0170-2BD37-3■A7	6SE0170-2BD38-2■A7
<i>Converter type</i> (liquid-cooled)		2T6F-77501-250	2T6F-77501-315	2T6F-77501-400	2T6F-77501-500	2T6F-77501-560
Electrical data at motor end						
Type rating¹⁾						
• at 50 Hz 500 V	kW	250	315	400	500	560
• at 60 Hz 460 V	hp	309	389	494	617	691
Output voltage²⁾	V	0 ... 0.98 × V _{line}	0 ... 0.98 × V _{line}	0 ... 0.98 × V _{line}	0 ... 0.98 × V _{line}	0 ... 0.98 × V _{line}
Output current						
• Continuous current	A	370	460	640	730	820
• Short-time current (60 s every 10 minutes) max.	A	450	560	700	900	980
Overload capability (60 s every 10 minutes) max.	%	22	22	9	23	20
Output power	kVA	320	398	554	632	710
Output frequency, max.	Hz	250	250	250	120	120
Rated clock cycle	kHz	3	3	2.4	2.4	2.4
adjustable from	kHz	2 ... 5	2 ... 5	1.5 ... 3.7	1.5 ... 3.7	1.5 ... 3.7
Power loss³⁾	kW	6.15	7.39	9.37	12.8	13.7
Rated efficiency	%	97.7	97.8	97.8	97.6	97.7
Electrical data at line end						
Connected load	kVA	303	378	516	606	677
Rated input voltage	V	2 × 500	2 × 500	2 × 500	2 × 500	2 × 500
Input current						
• Continuous line current	A	2 × 175	2 × 218	2 × 298	2 × 350	2 × 391
• Short-time line current (60 s) max.	A	2 × 213	2 × 265	2 × 326	2 × 432	2 × 467
Line fuse (provided by customer)	gL (A)	200	250	400	400	500
λ_{line}		0.994	0.994	0.994	0.996	0.996
cos ϕ_{line}		1	1	1	1	1
Radio interference suppression acc. to EN 61800-3		C4	C4	C4	C4	C4
Mechanical data for air-cooled cabinet units						
Frame size (dimensional drawing classification)		SL5	SL5	SL5	SL5	SL6
Sound pressure level L_{pA} (1 m) at 50/60 Hz	dB	70	73	73	75	75
Standard converter dimensions						
• Width	mm	1406	1406	1406	1406	1806
• Height ⁴⁾	mm	2112	2112	2112	2112	2112
• Depth	mm	605	605	605	605	605
Coolant requirements	m ³ /h	1900	1900	1900	2250	3200
Weight, approx.	kg	690	710	730	810	920
Mechanical data for liquid-cooled cabinet units						
Frame size (dimensional drawing classification)		SW5	SW5	SW5	SW5	SW6
Sound pressure level L_{pA} (1 m) at 50/60 Hz	dB	68	71	71	73	73
Standard converter dimensions						
• Width	mm	1406	1406	1406	1406	2006
• Height	mm	2202	2202	2202	2202	2202
• Depth	mm	605	605	605	605	605
Coolant requirements	l/h	1200	1200	1200	1200	2000
Min. coolant pressure	bar	2.5	2.5	2.5	2.5	2.5
Max. coolant pressure	bar	6	6	6	6	6
Coolant test pressure	bar	10	10	10	10	10
Coolant pressure loss	bar	1.9	1.9	1.9	1.9	1.9
Min. coolant temperature	°C	10	10	10	10	10
Max. coolant temperature	°C	35	35	35	30	35
Weight, approx.	kg	690	710	730	810	950

For footnotes, see next page.

SINAMICS G180

SINAMICS G180 cabinet units

SINAMICS G180 cabinet units
air-cooled and liquid-cooled

Technical data (continued)

Line voltage, supply system type	2 × 400, 415, 460, 500 V 3 AC IT				
SINAMICS G180 cabinet units – air-cooled	6SE0180-2BD33-7■A7	6SE0180-2BD34-6■A7	6SE0180-2BD36-3■A7	6SE0180-2BD37-3■A7	6SE0180-2BD38-2■A7
<i>Converter type</i> (air-cooled)	2T3F-87501-250	2T3F-87501-315	2T3F-87501-400	2T3F-87501-500	2T3F-87501-560
SINAMICS G180 cabinet units – liquid-cooled	6SE0170-2BD33-7■A7	6SE0170-2BD34-6■A7	6SE0170-2BD36-3■A7	6SE0170-2BD37-3■A7	6SE0170-2BD38-2■A7
<i>Converter type</i> (liquid-cooled)	2T6F-77501-250	2T6F-77501-315	2T6F-77501-400	2T6F-77501-500	2T6F-77501-560
General mechanical data					
Max. cable length between converter and motor with standard insulation (shielded)	m	250 ⁵⁾	250 ⁵⁾	250 ⁵⁾	250 ⁵⁾
Line/load connection					
L1, L2, L3/U2, V2, W2 For connection cross-sections, see "Cable cross-sections and connections" in section "Configuring instructions"					
Approvals, according to		NRTL ⁶⁾	NRTL ⁶⁾	NRTL ⁶⁾	NRTL ⁶⁾

3

1) Rated power of a typical 2- to 6-pole standard motor.
 2) Typical output voltage dependent on filter and unit type.
 3) Maximum power loss with continuous motor current.
 4) With IP21 protective top cover (110 mm).

5) Option L10 included (strengthened dv/dt filter; strengthened filter is integrated in unit).
 6) On request.

SINAMICS G180

SINAMICS G180 cabinet units

SINAMICS G180 cabinet units air-cooled and liquid-cooled

Technical data (continued)

500 V, 12-pulse (continued)

Line voltage, supply system type		2 × 400, 415, 460, 500 V 3 AC IT		
SINAMICS G180 cabinet units – air-cooled		6SE0180-2BD38-8■A7 <i>2T3F-87501-630</i>	6SE0180-2BD41-0■A7 <i>2T3F-87501-710</i>	6SE0180-2BD41-1■A7 <i>2T3F-87501-800</i>
<i>Converter type</i> (air-cooled)				
SINAMICS G180 cabinet units – liquid-cooled		6SE0170-2BD38-8■A7 <i>2T6F-77501-630</i>	6SE0170-2BD41-0■A7 <i>2T6F-77501-710</i>	6SE0170-2BD41-1■A7 <i>2T6F-77501-800</i>
<i>Converter type</i> (liquid-cooled)				
Electrical data at motor end				
Type rating¹⁾				
• at 50 Hz 500 V	kW	630	710	800
• at 60 Hz 460 V	hp	777	876	987
Output voltage²⁾	V	0 ... 0.98 × V _{line}	0 ... 0.98 × V _{line}	0 ... 0.98 × V _{line}
Output current				
• Continuous current	A	920	1030	1150
• Short-time current (60 s every 10 minutes) max.	A	1100	1230	1380
Overload capability (60 s every 10 minutes) max.	%	20	19	20
Output power	kVA	797	892	996
Output frequency, max.	Hz	120	120	120
Rated clock cycle	kHz	2.4	2.4	2.4
adjustable from	kHz	1.5 ... 3.7	1.5 ... 3.7	1.5 ... 3.7
Power loss³⁾	kW	15.4	18.1	20.3
Rated efficiency	%	97.7	97.6	97.6
Electrical data at line end				
Connected load	kVA	767	849	944
Rated input voltage	V	2 × 500	2 × 500	2 × 500
Input current				
• Continuous line current	A	2 × 443	2 × 490	2 × 545
• Short-time line current (60 s) max.	A	2 × 530	2 × 585	2 × 654
Line fuse (provided by customer)	gL (A)	500	630	630
λ_{line}		0.996	0.996	0.997
cos ϕ_{line}		1	1	1
Radio interference suppression acc. to EN 61800-3		C4	C4	C4
Mechanical data for air-cooled cabinet units				
Frame size (dimensional drawing classification)		SL6	SL6	SL6
Sound pressure level L_{pA} (1 m) at 50/60 Hz	dB	75	75	75
Standard converter dimensions				
• Width	mm	1806	1806	1806
• Height ⁴⁾	mm	2112	2112	2112
• Depth	mm	605	605	605
Coolant requirements	m ³ /h	3800	3200	3800
Weight, approx.	kg	930	960	1010
Mechanical data for liquid-cooled cabinet units				
Frame size (dimensional drawing classification)		SW6	SW6	SW6
Sound pressure level L_{pA} (1 m) at 50/60 Hz	dB	73	73	73
Standard converter dimensions				
• Width	mm	2006	2006	2006
• Height	mm	2202	2202	2202
• Depth	mm	605	605	605
Coolant requirements	l/h	2000	2000	2000
Min. coolant pressure	bar	2.5	2.5	2.5
Max. coolant pressure	bar	6	6	6
Coolant test pressure	bar	10	10	10
Coolant pressure loss	bar	1.9	1.9	1.9
Min. coolant temperature	°C	10	10	10
Max. coolant temperature	°C	35	35	30
Weight, approx.	kg	960	990	1040

For footnotes, see next page.

SINAMICS G180

SINAMICS G180 cabinet units

SINAMICS G180 cabinet units
air-cooled and liquid-cooled

Technical data (continued)

Line voltage, supply system type	2 × 400, 415, 460, 500 V 3 AC IT		
SINAMICS G180 cabinet units – air-cooled	6SE0180-2BD38-8■A7	6SE0180-2BD41-0■A7	6SE0180-2BD41-1■A7
<i>Converter type</i> (air-cooled)	<i>2T3F-87501-630</i>	<i>2T3F-87501-710</i>	<i>2T3F-87501-800</i>
SINAMICS G180 cabinet units – liquid-cooled	6SE0170-2BD38-8■A7	6SE0170-2BD41-0■A7	6SE0170-2BD41-1■A7
<i>Converter type</i> (liquid-cooled)	<i>2T6F-77501-630</i>	<i>2T6F-77501-710</i>	<i>2T6F-77501-800</i>
General mechanical data			
Max. cable length between converter and motor with standard insulation (shielded)	m	250 ⁵⁾	250 ⁵⁾
Line/load connection			
L1, L2, L3/U2, V2, W2 For connection cross-sections, see "Cable cross-sections and connections" in section "Configuring instructions"			
Approvals, according to		NRTL ⁶⁾	NRTL ⁶⁾

3

1) Rated power of a typical 2- to 6-pole standard motor.
 2) Typical output voltage dependent on filter and unit type.
 3) Maximum power loss with continuous motor current.
 4) With IP21 protective top cover (110 mm).

5) Option L10 included (strengthened dv/dt filter; strengthened filter is integrated in unit).
 6) On request.

SINAMICS G180

SINAMICS G180 cabinet units

SINAMICS G180 cabinet units air-cooled and liquid-cooled

Technical data (continued)

690 V, 6-pulse

Line voltage, supply system type	400, 415, 460, 500, 575, 690 V 3 AC TT/TN or IT					
SINAMICS G180 cabinet units – air-cooled	6SE0180-1B33-2A7	6SE0180-1B33-6A7	6SE0180-1B34-2A7	6SE0180-1B35-2A7	6SE0180-1B35-7A7	6SE0180-1B35-7A7
<i>Converter type</i> (air-cooled)	2T3A-87601-250	2T3A-87601-315	2T3A-87601-400	2T3A-87601-500	2T3A-87601-560	2T3A-87601-560
SINAMICS G180 cabinet units – liquid-cooled	6SE0170-1B33-2A7	6SE0170-1B33-6A7	6SE0170-1B34-2A7	6SE0170-1B35-2A7	6SE0170-1B35-7A7	6SE0170-1B35-7A7
<i>Converter type</i> (liquid-cooled)	2T6A-77601-250	2T6A-77601-315	2T6A-77601-400	2T6A-77601-500	2T6A-77601-560	2T6A-77601-560

Electrical data at motor end

Type rating¹⁾						
• at 50 Hz 690 V	kW	250	315	400	500	560
• at 60 Hz 575 V	hp	279	352	447	559	626
Output voltage²⁾	V	0 ... 0.98 × V _{line}	0 ... 0.98 × V _{line}	0 ... 0.98 × V _{line}	0 ... 0.98 × V _{line}	0 ... 0.98 × V _{line}
Output current						
• Continuous current	A	270	340	440	530	590
• Short-time current (60 s every 10 minutes) max.	A	320	410	510	640	710
Overload capability (60 s every 10 minutes) max.	%	19	21	16	21	20
Output power	kVA	323	406	526	633	705
Output frequency, max.	Hz	250	250	250	120	120
Rated clock cycle	kHz	3	3	2.4	2.4	2.4
adjustable from	kHz	2 ... 5	2 ... 5	1.5 ... 3.7	1.5 ... 3.7	1.5 ... 3.7
Power loss³⁾	kW	6.15	7.73	9.37	12.2	13.7
Rated efficiency	%	97.7	97.7	97.8	97.7	97.7

Electrical data at line end

Connected load	kVA	312	391	502	608	676
Rated input voltage	V	690	690	690	690	690
Input current						
• Continuous line current	A	261	327	420	509	566
• Short-time line current (60 s) max.	A	309	394	487	615	681
Line fuse (provided by customer)	gL (A)	315	400	500	630	630
λ_{line}		0.901	0.905	0.91	0.939	0.94
cos ϕ_{line}		1	1	1	1	1
Radio interference suppression acc. to EN 61800-3⁴⁾		C3 (class A filter)	C3 (class A filter)	C3 (class A filter)	C3 (class A filter)	C3 (class A filter)

Mechanical data for air-cooled cabinet units

Frame size (dimensional drawing classification)	SL2	SL2	SL2	SL21	SL3
Sound pressure level L_{pA} (1 m) at 50/60 Hz	dB	70	70	70	75
Standard converter dimensions					
• Width	mm	806	806	806	1206
• Height ⁵⁾	mm	2112	2112	2112	2112
• Depth	mm	605	605	605	605
Coolant requirements	m ³ /h	1900	1900	1900	2650
Weight, approx.	kg	490	510	530	780

Mechanical data for liquid-cooled cabinet units

Frame size (dimensional drawing classification)	SW2	SW2	SW2	SW21	SW3
Sound pressure level L_{pA} (1 m) at 50/60 Hz	dB	68	68	68	73
Standard converter dimensions					
• Width	mm	806	806	806	1206
• Height	mm	2202	2202	2202	2202
• Depth	mm	605	605	605	605
Coolant requirements	l/h	1200	1200	1200	1200
Min. coolant pressure	bar	2.5	2.5	2.5	2.5
Max. coolant pressure	bar	6	6	6	6
Coolant test pressure	bar	10	10	10	10
Coolant pressure loss	bar	1.9	1.9	1.9	1.9
Min. coolant temperature	°C	10	10	10	10
Max. coolant temperature	°C	35	35	35	35
Weight, approx.	kg	490	510	530	850

For footnotes, see next page.

SINAMICS G180

SINAMICS G180 cabinet units

SINAMICS G180 cabinet units
air-cooled and liquid-cooled

Technical data (continued)

Line voltage, supply system type	400, 415, 460, 500, 575, 690 V 3 AC TT/TN or IT				
SINAMICS G180 cabinet units – air-cooled	6SE0180-1B33-2A7	6SE0180-1B33-6A7	6SE0180-1B34-2A7	6SE0180-1B35-2A7	6SE0180-1B35-7A7
<i>Converter type</i> (air-cooled)	2T3A-87601-250	2T3A-87601-315	2T3A-87601-400	2T3A-87601-500	2T3A-87601-560
SINAMICS G180 cabinet units – liquid-cooled	6SE0170-1B33-2A7	6SE0170-1B33-6A7	6SE0170-1B34-2A7	6SE0170-1B35-2A7	6SE0170-1B35-7A7
<i>Converter type</i> (liquid-cooled)	2T6A-77601-250	2T6A-77601-315	2T6A-77601-400	2T6A-77601-500	2T6A-77601-560
General mechanical data					
Max. cable length between converter and motor with standard insulation (shielded)	m	100/250 ⁶⁾	100/250 ⁶⁾	100/250 ⁶⁾	100/250 ⁷⁾
Line/load connection					
L1, L2, L3/U2, V2, W2					
For connection cross-sections, see "Cable cross-sections and connections" in section "Configuring instructions"					
Approvals, according to		NRTL ⁸⁾	NRTL ⁸⁾	NRTL ⁸⁾	NRTL ⁸⁾

3

¹⁾ Rated power of a typical 2- to 6-pole standard motor.

²⁾ Typical output voltage dependent on filter and unit type.

³⁾ Maximum power loss with continuous motor current.

⁴⁾ EMC filter not required for IT system, in which case RI suppression category C4.

⁵⁾ With IP21 protective top cover (110 mm).

⁶⁾ Value is applicable with option L10 (strengthened dv/dt filter; filter is integrated in additional 400 mm cabinet).

⁷⁾ Value is applicable with option L10 (strengthened dv/dt filter; filter is integrated in unit).

⁸⁾ On request; the voltage range for NRTL units ends at max. 600 V.

SINAMICS G180

SINAMICS G180 cabinet units

SINAMICS G180 cabinet units air-cooled and liquid-cooled

Technical data (continued)

690 V, 6-pulse (continued)

Line voltage, supply system type		400, 415, 460, 500, 575, 690 V 3 AC TT/TN or IT				
SINAMICS G180 cabinet units – air-cooled		6SE0180-1B36-4A7	6SE0180-1B37-1A7	6SE0180-1B37-7A7	6SE0180-1B41-0A7	6SE0180-1B41-1A7
<i>Converter type</i> (air-cooled)		2T3A-87601-630	2T3A-87601-710	2T3A-87601-800	2T3A-87601-909	2T3A-87601-910
SINAMICS G180 cabinet units – liquid-cooled		6SE0170-1B36-4A7	6SE0170-1B37-1A7	6SE0170-1B37-7A7	6SE0170-1B41-0A7	6SE0170-1B41-1A7
<i>Converter type</i> (liquid-cooled)		2T6A-77601-630	2T6A-77601-710	2T6A-77601-800	2T6A-77601-909	2T6A-77601-910
Electrical data at motor end						
Type rating¹⁾						
• at 50 Hz 690 V	kW	630	710	800	900	1000
• at 60 Hz 575 V	hp	704	794	894	1006	1118
Output voltage²⁾	V	0 ... 0.98 × V _{line}	0 ... 0.98 × V _{line}	0 ... 0.98 × V _{line}	0 ... 0.98 × V _{line}	0 ... 0.98 × V _{line}
Output current						
• Continuous current	A	660	750	840	950	1040
• Short-time current (60 s every 10 minutes) max.	A	800	890	980	1060	1130
Overload capability (60 s every 10 minutes) max.	%	21	19	17	12	9
Output power	kVA	789	896	1004	1135	1243
Output frequency, max.	Hz	120	120	120	120	120
Rated clock cycle	kHz	2.4	2.4	2.4	2.4	2.4
adjustable from	kHz	1.5 ... 3.7	1.5 ... 3.7	1.5 ... 3.7	1.5 ... 3.7	1.5 ... 3.7
Power loss³⁾	kW	15.4	16.6	18.7	21	23.3
Rated efficiency	%	97.7	97.8	97.8	97.8	97.8
Electrical data at line end						
Connected load	kVA	764	854	956	1078	1165
Rated input voltage	V	690	690	690	690	690
Input current						
• Continuous line current	A	639	715	800	902	975
• Short-time line current (60 s) max.	A	774	848	933	1006	1059
Line fuse (provided by customer)	gL (A)	800	800	900	1000	1000
λ_{line}		0.942	0.944	0.945	0.947	0.949
cos ϕ_{line}		1	1	1	1	1
Radio interference suppression acc. to EN 61800-3⁴⁾		C3 (class A filter)	C3 (class A filter)	C3 (class A filter)	C3 (class A filter)	C3 (class A filter)
Mechanical data for air-cooled cabinet units						
Frame size (dimensional drawing classification)		SL3	SL3	SL3	SL3	SL3
Sound pressure level L_{pA} (1 m) at 50/60 Hz	dB	75	75	75	75	75
Standard converter dimensions						
• Width	mm	1606	1606	1606	1606	1606
• Height ⁵⁾	mm	2112	2112	2112	2112	2112
• Depth	mm	605	605	605	605	605
Coolant requirements	m ³ /h	3200	3800	3200	3800	3800
Weight, approx.	kg	890	900	930	980	1030
Mechanical data for liquid-cooled cabinet units						
Frame size (dimensional drawing classification)		SW3	SW3	SW3	SW3	SW3
Sound pressure level L_{pA} (1 m) at 50/60 Hz	dB	73	73	73	73	73
Standard converter dimensions						
• Width	mm	1806	1806	1806	1806	1806
• Height	mm	2202	2202	2202	2202	2202
• Depth	mm	605	605	605	605	605
Coolant requirements	l/h	2000	2000	2000	2000	2000
Min. coolant pressure	bar	2.5	2.5	2.5	2.5	2.5
Max. coolant pressure	bar	6	6	6	6	6
Coolant test pressure	bar	10	10	10	10	10
Coolant pressure loss	bar	1.9	1.9	1.9	1.9	1.9
Min. coolant temperature	°C	10	10	10	10	10
Max. coolant temperature	°C	35	35	35	30	28
Weight, approx.	kg	920	930	960	1010	1060

For footnotes, see next page.

SINAMICS G180

SINAMICS G180 cabinet units

SINAMICS G180 cabinet units
air-cooled and liquid-cooled

Technical data (continued)

Line voltage, supply system type	400, 415, 460, 500, 575, 690 V 3 AC TT/TN or IT				
SINAMICS G180 cabinet units – air-cooled	6SE0180-1B36-4A7	6SE0180-1B37-1A7	6SE0180-1B37-7A7	6SE0180-1B41-0A7	6SE0180-1B41-1A7
<i>Converter type</i> (air-cooled)	2T3A-87601-630	2T3A-87601-710	2T3A-87601-800	2T3A-87601-909	2T3A-87601-910
SINAMICS G180 cabinet units – liquid-cooled	6SE0170-1B36-4A7	6SE0170-1B37-1A7	6SE0170-1B37-7A7	6SE0170-1B41-0A7	6SE0170-1B41-1A7
<i>Converter type</i> (liquid-cooled)	2T6A-77601-630	2T6A-77601-710	2T6A-77601-800	2T6A-77601-909	2T6A-77601-910
General mechanical data					
Max. cable length between converter and motor with standard insulation (shielded)	m	100/250 ⁶⁾	100/250 ⁶⁾	100/250 ⁷⁾	100/250 ⁷⁾
Line/load connection					
L1, L2, L3/U2, V2, W2 For connection cross-sections, see "Cable cross-sections and connections" in section "Configuring instructions"					
Approvals, according to		NRTL ⁸⁾	NRTL ⁸⁾	NRTL ⁸⁾	NRTL ⁸⁾

3

¹⁾ Rated power of a typical 2- to 6-pole standard motor.

²⁾ Typical output voltage dependent on filter and unit type.

³⁾ Maximum power loss with continuous motor current.

⁴⁾ EMC filter not required for IT system, in which case RI suppression category C4.

⁵⁾ With IP21 protective top cover (110 mm).

⁶⁾ Value is applicable with option L10 (strengthened dv/dt filter; filter is integrated in unit).

⁷⁾ Value is applicable with option L10 (strengthened dv/dt filter; filter is integrated in additional 600 mm cabinet).

⁸⁾ On request; the voltage range for NRTL units ends at max. 600 V.

SINAMICS G180

SINAMICS G180 cabinet units

SINAMICS G180 cabinet units air-cooled and liquid-cooled

Technical data (continued)

690 V, 6-pulse (continued)

Line voltage, supply system type		400, 415, 460, 500, 575, 690 V 3 AC TT/TN or IT				
SINAMICS G180 cabinet units – air-cooled		6SE0180-1C■41-2■A7	6SE0180-1C■41-3■A7	6SE0180-1C■41-5■A7	6SE0180-1C■41-7■A7	6SE0180-1C■42-0■A7
<i>Converter type</i> (air-cooled)		2T3A-87602-912	2T3A-87602-913	2T3A-87602-915	2T3A-87602-917	2T3A-87602-919
SINAMICS G180 cabinet units – liquid-cooled		6SE0170-1C■41-2■A7	6SE0170-1C■41-3■A7	6SE0170-1C■41-5■A7	6SE0170-1C■41-7■A7	6SE0170-1C■42-0■A7
<i>Converter type</i> (liquid-cooled)		2T6A-77602-912	2T6A-77602-913	2T6A-77602-915	2T6A-77602-917	2T6A-77602-919
Electrical data at motor end						
Type rating¹⁾						
• at 50 Hz 690 V	kW	1200	1300	1500	1700	1900
• at 60 Hz 575 V	hp	1341	1453	1676	1900	2123
Output voltage²⁾	V	0 ... 0.98 × V _{line}	0 ... 0.98 × V _{line}	0 ... 0.98 × V _{line}	0 ... 0.98 × V _{line}	0 ... 0.98 × V _{line}
Output current						
• Continuous current	A	1260	1430	1600	1810	1980
• Short-time current (60 s every 10 minutes) max.	A	1520	1700	1870	2020	2150
Overload capability (60 s every 10 minutes) max.	%	21	19	17	12	9
Output power	kVA	1506	1709	1912	2163	2366
Output frequency, max.	Hz	120	120	120	120	120
Rated clock cycle	kHz	2.4	2.4	2.4	2.4	2.4
adjustable from	kHz	1.5 ... 3.7	1.5 ... 3.7	1.5 ... 3.7	1.5 ... 3.7	1.5 ... 3.7
Power loss³⁾	kW	28.2	33.6	37.5	42.6	46.5
Rated efficiency	%	97.8	97.7	97.7	97.7	97.7
Electrical data at line end						
Connected load	kVA	1410	1603	1795	2030	2220
Rated input voltage	V	690	690	690	690	690
Input current						
• Continuous line current	A	1180	1341	1502	1699	1858
• Short-time line current (60 s) max.	A	1424	1594	1756	1896	2018
Line fuse (provided by customer)	gL (A)	1250	1500	1600	1800	2000
λ_{line}		0.952	0.954	0.956	0.958	0.96
cos ϕ_{line}		1	1	1	1	1
Radio interference suppression acc. to EN 61800-3⁴⁾		C3 (class A filter)	C3 (class A filter)	C3 (class A filter)	C3 (class A filter)	C3 (class A filter)
Mechanical data for air-cooled cabinet units						
Frame size (dimensional drawing classification)		SL4	SL4	SL4	SL4	SL4
Sound pressure level L_{pA} (1 m) at 50/60 Hz	dB	77	77	77	77	77
Standard converter dimensions						
• Width	mm	3206	3206	3206	3206	3206
• Height ⁵⁾	mm	2112	2112	2112	2112	2112
• Depth	mm	605	605	605	605	605
Coolant requirements	m ³ /h	6400	7600	6400	7600	7600
Weight, approx.	kg	1780	1800	1860	1960	2060
Mechanical data for liquid-cooled cabinet units						
Frame size (dimensional drawing classification)		SW4	SW4	SW4	SW4	SW4
Sound pressure level L_{pA} (1 m) at 50/60 Hz	dB	75	75	75	75	75
Standard converter dimensions						
• Width	mm	3606	3606	3606	3606	3606
• Height	mm	2202	2202	2202	2202	2202
• Depth	mm	605	605	605	605	605
Coolant requirements	l/h	4000	4000	4000	4000	4000
Min. coolant pressure	bar	2.5	2.5	2.5	2.5	2.5
Max. coolant pressure	bar	6	6	6	6	6
Coolant test pressure	bar	10	10	10	10	10
Coolant pressure loss	bar	1.9	1.9	1.9	1.9	1.9
Min. coolant temperature	°C	10	10	10	10	10
Max. coolant temperature	°C	35	35	35	30	28
Weight, approx.	kg	1840	1860	1920	2020	2120

For footnotes, see next page.

SINAMICS G180

SINAMICS G180 cabinet units

SINAMICS G180 cabinet units
air-cooled and liquid-cooled

Technical data (continued)

Line voltage, supply system type	400, 415, 460, 500, 575, 690 V 3 AC TT/TN or IT				
SINAMICS G180 cabinet units – air-cooled	6SE0180-1C41-2A7	6SE0180-1C41-3A7	6SE0180-1C41-5A7	6SE0180-1C41-7A7	6SE0180-1C42-0A7
<i>Converter type</i> (air-cooled)	2T3A-87602-912	2T3A-87602-913	2T3A-87602-915	2T3A-87602-917	2T3A-87602-919
SINAMICS G180 cabinet units – liquid-cooled	6SE0170-1C41-2A7	6SE0170-1C41-3A7	6SE0170-1C41-5A7	6SE0170-1C41-7A7	6SE0170-1C42-0A7
<i>Converter type</i> (liquid-cooled)	2T6A-77602-912	2T6A-77602-913	2T6A-77602-915	2T6A-77602-917	2T6A-77602-919
General mechanical data					
Max. cable length between converter and motor with standard insulation (shielded)	m	100/250 ⁶⁾	100/250 ⁶⁾	100/250 ⁷⁾	100/250 ⁷⁾
Line/load connection					
L1, L2, L3/U2, V2, W2					
For connection cross-sections, see "Cable cross-sections and connections" in section "Configuring instructions"					
Approvals, according to		NRTL ⁸⁾	NRTL ⁸⁾	NRTL ⁸⁾	NRTL ⁸⁾

3

¹⁾ Rated power of a typical 2- to 6-pole standard motor.

²⁾ Typical output voltage dependent on filter and unit type.

³⁾ Maximum power loss with continuous motor current.

⁴⁾ EMC filter not required for IT system, in which case RI suppression category C4.

⁵⁾ With IP21 protective top cover (110 mm).

⁶⁾ Value is applicable with option L10 (strengthened dv/dt filter; filter is integrated in unit).

⁷⁾ Value is applicable with option L10 (strengthened dv/dt filter; filter is integrated in additional 2 × 600 mm cabinet).

⁸⁾ On request; the voltage range for NRTL units ends at max. 600 V.

SINAMICS G180

SINAMICS G180 cabinet units

SINAMICS G180 cabinet units air-cooled and liquid-cooled

Technical data (continued)

690 V, 12-pulse

Line voltage, supply system type		2 × 400, 415, 460, 500, 575, 690 V 3 AC IT				
SINAMICS G180 cabinet units – air-cooled		6SE0180-2BH33-2■A7	6SE0180-2BH33-6■A7	6SE0180-2BH34-2■A7	6SE0180-2BH35-2■A7	6SE0180-2BH35-7■A7
<i>Converter type</i> (air-cooled)		2T3F-87601-250	2T3F-87601-315	2T3F-87601-400	2T3F-87601-500	2T3F-87601-560
SINAMICS G180 cabinet units – liquid-cooled		6SE0170-2BH33-2■A7	6SE0170-2BH33-6■A7	6SE0170-2BH34-2■A7	6SE0170-2BH35-2■A7	6SE0170-2BH35-7■A7
<i>Converter type</i> (liquid-cooled)		2T6F-77601-250	2T6F-77601-315	2T6F-77601-400	2T6F-77601-500	2T6F-77601-560
Electrical data at motor end						
Type rating¹⁾						
• at 50 Hz 690 V	kW	250	315	400	500	560
• at 60 Hz 575 V	hp	279	352	447	559	626
Output voltage²⁾	V	0 ... 0.98 × V _{line}	0 ... 0.98 × V _{line}	0 ... 0.98 × V _{line}	0 ... 0.98 × V _{line}	0 ... 0.98 × V _{line}
Output current						
• Continuous current	A	270	340	440	530	590
• Short-time current (60 s every 10 minutes) max.	A	320	410	510	640	710
Overload capability (60 s every 10 minutes) max.	%	19	21	16	21	20
Output power	kVA	323	406	526	633	705
Output frequency, max.	Hz	250	250	250	120	120
Rated clock cycle	kHz	3	3	2.4	2.4	2.4
adjustable from	kHz	2 ... 5	2 ... 5	1.5 ... 3.7	1.5 ... 3.7	1.5 ... 3.7
Power loss³⁾	kW	6.15	7.73	9.37	12.2	13.7
Rated efficiency	%	97.7	97.7	97.8	97.7	97.7
Electrical data at line end						
Connected load	kVA	311	392	502	600	667
Rated input voltage	V	2 × 690	2 × 690	2 × 690	2 × 690	2 × 690
Input current						
• Continuous line current	A	2 × 130	2 × 164	2 × 210	2 × 251	2 × 279
• Short-time line current (60 s) max.	A	2 × 154	2 × 198	2 × 243	2 × 303	2 × 336
Line fuse (provided by customer)	gL (A)	160	200	250	315	315
λ_{line}		0.995	0.995	0.995	0.997	0.997
cos ϕ_{line}		1	1	1	1	1
Radio interference suppression acc. to EN 61800-3		C4	C4	C4	C4	C4
Mechanical data for air-cooled cabinet units						
Frame size (dimensional drawing classification)		SL5	SL5	SL5	SL5	SL6
Sound pressure level L_{pA} (1 m) at 50/60 Hz	dB	70	70	70	75	75
Standard converter dimensions						
• Width	mm	1406	1406	1406	1406	1806
• Height ⁴⁾	mm	2112	2112	2112	2112	2112
• Depth	mm	605	605	605	605	605
Coolant requirements	m ³ /h	1900	1900	1900	2650	3200
Weight, approx.	kg	690	710	730	810	920
Mechanical data for liquid-cooled cabinet units						
Frame size (dimensional drawing classification)		SW5	SW5	SW5	SW5	SW6
Sound pressure level L_{pA} (1 m) at 50/60 Hz	dB	68	68	68	73	73
Standard converter dimensions						
• Width	mm	1406	1406	1406	1406	2006
• Height	mm	2202	2202	2202	2202	2202
• Depth	mm	605	605	605	605	605
Coolant requirements	l/h	1200	1200	1200	1200	2000
Min. coolant pressure	bar	2.5	2.5	2.5	2.5	2.5
Max. coolant pressure	bar	6	6	6	6	6
Coolant test pressure	bar	10	10	10	10	10
Coolant pressure loss	bar	1.9	1.9	1.9	1.9	1.9
Min. coolant temperature	°C	10	10	10	10	10
Max. coolant temperature	°C	35	35	35	30	35
Weight, approx.	kg	690	710	730	810	950

For footnotes, see next page.

SINAMICS G180

SINAMICS G180 cabinet units

SINAMICS G180 cabinet units
air-cooled and liquid-cooled

Technical data (continued)

Line voltage, supply system type	2 × 400, 415, 460, 500, 575, 690 V 3 AC IT					
SINAMICS G180 cabinet units – air-cooled	6SE0180-2BH33-2■A7	6SE0180-2BH33-6■A7	6SE0180-2BH34-2■A7	6SE0180-2BH35-2■A7	6SE0180-2BH35-7■A7	
<i>Converter type</i> (air-cooled)	<i>2T3F-87601-250</i>	<i>2T3F-87601-315</i>	<i>2T3F-87601-400</i>	<i>2T3F-87601-500</i>	<i>2T3F-87601-560</i>	
SINAMICS G180 cabinet units – liquid-cooled	6SE0170-2BH33-2■A7	6SE0170-2BH33-6■A7	6SE0170-2BH34-2■A7	6SE0170-2BH35-2■A7	6SE0170-2BH35-7■A7	
<i>Converter type</i> (liquid-cooled)	<i>2T6F-77601-250</i>	<i>2T6F-77601-315</i>	<i>2T6F-77601-400</i>	<i>2T6F-77601-500</i>	<i>2T6F-77601-560</i>	
General mechanical data						
Max. cable length between converter and motor with standard insulation (shielded)	m	100/250 ⁵⁾	100/250 ⁵⁾	100/250 ⁵⁾	100/250 ⁵⁾	100/250 ⁶⁾
Line/load connection						
L1, L2, L3/U2, V2, W2						
For connection cross-sections, see "Cable cross-sections and connections" in section "Configuring instructions"						
Approvals, according to		NRTL ⁷⁾	NRTL ⁷⁾	NRTL ⁷⁾	NRTL ⁷⁾	NRTL ⁷⁾

3

¹⁾ Rated power of a typical 2- to 6-pole standard motor.

²⁾ Typical output voltage dependent on filter and unit type.

³⁾ Maximum power loss with continuous motor current.

⁴⁾ With IP21 protective top cover (110 mm).

⁵⁾ Value is applicable with option L10 (strengthened dv/dt filter; filter is integrated in additional 400 mm cabinet).

⁶⁾ Value is applicable with option L10 (strengthened dv/dt filter; filter is integrated in unit).

⁷⁾ On request; the voltage range for NRTL units ends at max. 600 V.

SINAMICS G180

SINAMICS G180 cabinet units

SINAMICS G180 cabinet units air-cooled and liquid-cooled

Technical data (continued)

690 V, 12-pulse (continued)

Line voltage, supply system type		2 × 400, 415, 460, 500, 575, 690 V 3 AC IT				
SINAMICS G180 cabinet units – air-cooled		6SE0180-2BH36-4■A7	6SE0180-2BH37-1■A7	6SE0180-2BH37-7■A7	6SE0180-2BH41-0■A7	6SE0180-2BH41-1■A7
<i>Converter type</i> (air-cooled)		2T3F-87601-630	2T3F-87601-710	2T3F-87601-800	2T3F-87601-909	2T3F-87601-910
SINAMICS G180 cabinet units – liquid-cooled		6SE0170-2BH36-4■A7	6SE0170-2BH37-1■A7	6SE0170-2BH37-7■A7	6SE0170-2BH41-0■A7	6SE0170-2BH41-1■A7
<i>Converter type</i> (liquid-cooled)		2T6F-77601-630	2T6F-77601-710	2T6F-77601-800	2T6F-77601-909	2T6F-77601-910
Electrical data at motor end						
Type rating¹⁾						
• at 50 Hz 690 V	kW	630	710	800	900	1000
• at 60 Hz 575 V	hp	704	794	894	1006	1118
Output voltage²⁾	V	0 ... 0.98 × V _{line}	0 ... 0.98 × V _{line}	0 ... 0.98 × V _{line}	0 ... 0.98 × V _{line}	0 ... 0.98 × V _{line}
Output current						
• Continuous current	A	660	750	840	950	1040
• Short-time current (60 s every 10 minutes) max.	A	800	890	980	1060	1130
Overload capability (60 s every 10 minutes) max.	%	21	19	17	12	9
Output power	kVA	789	896	1004	1135	1243
Output frequency, max.	Hz	120	120	120	120	120
Rated clock cycle	kHz	2.4	2.4	2.4	2.4	2.4
adjustable from	kHz	1.5 ... 3.7	1.5 ... 3.7	1.5 ... 3.7	1.5 ... 3.7	1.5 ... 3.7
Power loss³⁾	kW	15.4	16.6	18.7	21	23.3
Rated efficiency	%	97.7	97.8	97.8	97.8	97.8
Electrical data at line end						
Connected load	kVA	755	848	949	1071	1159
Rated input voltage	V	2 × 690	2 × 690	2 × 690	2 × 690	2 × 690
Input current						
• Continuous line current	A	2 × 316	2 × 355	2 × 397	2 × 448	2 × 485
• Short-time line current (60 s) max.	A	2 × 383	2 × 421	2 × 463	2 × 500	2 × 527
Line fuse (provided by customer)	gL (A)	400	400	500	500	630
λ_{line}		0.997	0.997	0.997	0.997	0.997
cos ϕ_{line}		1	1	1	1	1
Radio interference suppression acc. to EN 61800-3		C4	C4	C4	C4	C4
Mechanical data for air-cooled cabinet units						
Frame size (dimensional drawing classification)		SL6	SL6	SL6	SL6	SL6
Sound pressure level L_{pA} (1 m) at 50/60 Hz	dB	75	75	75	75	75
Standard converter dimensions						
• Width	mm	1806	1806	1806	1806	1806
• Height ⁴⁾	mm	2112	2112	2112	2112	2112
• Depth	mm	605	605	605	605	605
Coolant requirements	m ³ /h	3200	3800	3200	3800	3800
Weight, approx.	kg	920	930	960	1010	1060
Mechanical data for liquid-cooled cabinet units						
Frame size (dimensional drawing classification)		SW6	SW6	SW6	SW6	SW6
Sound pressure level L_{pA} (1 m) at 50/60 Hz	dB	73	73	73	73	73
Standard converter dimensions						
• Width	mm	2006	2006	2006	2006	2006
• Height	mm	2202	2202	2202	2202	2202
• Depth	mm	605	605	605	605	605
Coolant requirements	l/h	2000	2000	2000	2000	2000
Min. coolant pressure	bar	2.5	2.5	2.5	2.5	2.5
Max. coolant pressure	bar	6	6	6	6	6
Coolant test pressure	bar	10	10	10	10	10
Coolant pressure loss	bar	1.9	1.9	1.9	1.9	1.9
Min. coolant temperature	°C	10	10	10	10	10
Max. coolant temperature	°C	35	35	35	30	28
Weight, approx.	kg	950	960	990	1040	1090

For footnotes, see next page.

SINAMICS G180

SINAMICS G180 cabinet units

SINAMICS G180 cabinet units
air-cooled and liquid-cooled

Technical data (continued)

Line voltage, supply system type		2 × 400, 415, 460, 500, 575, 690 V 3 AC IT				
SINAMICS G180 cabinet units – air-cooled		6SE0180-2BH36-4■A7	6SE0180-2BH37-1■A7	6SE0180-2BH37-7■A7	6SE0180-2BH41-0■A7	6SE0180-2BH41-1■A7
<i>Converter type</i> (air-cooled)		2T3F-87601-630	2T3F-87601-710	2T3F-87601-800	2T3F-87601-909	2T3F-87601-910
SINAMICS G180 cabinet units – liquid-cooled		6SE0170-2BH36-4■A7	6SE0170-2BH37-1■A7	6SE0170-2BH37-7■A7	6SE0170-2BH41-0■A7	6SE0170-2BH41-1■A7
<i>Converter type</i> (liquid-cooled)		2T6F-77601-630	2T6F-77601-710	2T6F-77601-800	2T6F-77601-909	2T6F-77601-910
General mechanical data						
Max. cable length between converter and motor with standard insulation (shielded)		m	100/250 ⁵⁾	100/250 ⁵⁾	100/250 ⁶⁾	100/250 ⁶⁾
Line/load connection						
L1, L2, L3/U2, V2, W2						
For connection cross-sections, see "Cable cross-sections and connections" in section "Configuring instructions"						
Approvals, according to			NRTL ⁷⁾	NRTL ⁷⁾	NRTL ⁷⁾	NRTL ⁷⁾

3

¹⁾ Rated power of a typical 2- to 6-pole standard motor.

²⁾ Typical output voltage dependent on filter and unit type.

³⁾ Maximum power loss with continuous motor current.

⁴⁾ With IP21 protective top cover (110 mm).

⁵⁾ Value is applicable with option L10 (strengthened dv/dt filter; filter is integrated in unit).

⁶⁾ Value is applicable with option L10 (strengthened dv/dt filter; filter is integrated in additional 600 mm cabinet).

⁷⁾ On request; the voltage range for NRTL units ends at max. 600 V.

SINAMICS G180

SINAMICS G180 cabinet units

SINAMICS G180 cabinet units air-cooled and liquid-cooled

Technical data (continued)

690 V, 12-pulse (continued)

Line voltage, supply system type		2 × 400, 415, 460, 500, 575, 690 V 3 AC IT				
SINAMICS G180 cabinet units – air-cooled		6SE0180-2CH41-2■A7 <i>2T3F-87602-912</i>	6SE0180-2CH41-3■A7 <i>2T3F-87602-913</i>	6SE0180-2CH41-5■A7 <i>2T3F-87602-915</i>	6SE0180-2CH41-7■A7 <i>2T3F-87602-917</i>	6SE0180-2CH42-0■A7 <i>2T3F-87602-919</i>
<i>Converter type</i> (air-cooled)						
SINAMICS G180 cabinet units – liquid-cooled		6SE0170-2CH41-2■A7 <i>2T6F-77602-912</i>	6SE0170-2CH41-3■A7 <i>2T6F-77602-913</i>	6SE0170-2CH41-5■A7 <i>2T6F-77602-915</i>	6SE0170-2CH41-7■A7 <i>2T6F-77602-917</i>	6SE0170-2CH42-0■A7 <i>2T6F-77602-919</i>
<i>Converter type</i> (liquid-cooled)						
Electrical data at motor end						
Type rating¹⁾						
• at 50 Hz 690 V	kW	1200	1300	1500	1700	1900
• at 60 Hz 575 V	hp	1341	1453	1676	1900	2123
Output voltage²⁾	V	0 ... 0.98 × V _{line}	0 ... 0.98 × V _{line}	0 ... 0.98 × V _{line}	0 ... 0.98 × V _{line}	0 ... 0.98 × V _{line}
Output current						
• Continuous current	A	1260	1430	1600	1810	1980
• Short-time current (60 s every 10 minutes) max.	A	1520	1700	1870	2020	2150
Overload capability (60 s every 10 minutes) max.	%	21	19	17	12	9
Output power	kVA	1506	1709	1912	2163	2366
Output frequency, max.	Hz	120	120	120	120	120
Rated clock cycle	kHz	2.4	2.4	2.4	2.4	2.4
adjustable from	kHz	1.5 ... 3.7	1.5 ... 3.7	1.5 ... 3.7	1.5 ... 3.7	1.5 ... 3.7
Power loss³⁾	kW	28.2	33.6	37.5	42.6	46.5
Rated efficiency	%	97.8	97.7	97.7	97.7	97.7
Electrical data at line end						
Connected load	kVA	1405	1597	1781	2010	2194
Rated input voltage	V	2 × 690	2 × 690	2 × 690	2 × 690	2 × 690
Input current						
• Continuous line current	A	2 × 588	2 × 668	2 × 745	2 × 841	2 × 918
• Short-time line current (60 s) max.	A	2 × 709	2 × 794	2 × 871	2 × 939	2 × 997
Line fuse (provided by customer)	gL (A)	800	800	900	1000	1250
λ_{line}		0.997	0.997	0.997	0.997	0.997
cos ϕ_{line}		1	1	1	1	1
Radio interference suppression acc. to EN 61800-3		C4	C4	C4	C4	C4
Mechanical data for air-cooled cabinet units						
Frame size (dimensional drawing classification)		SL4	SL4	SL4	SL4	SL4
Sound pressure level L_{pA} (1 m) at 50/60 Hz	dB	77	77	77	77	77
Standard converter dimensions						
• Width	mm	3206	3206	3206	3206	3206
• Height ⁴⁾	mm	2112	2112	2112	2112	2112
• Depth	mm	605	605	605	605	605
Coolant requirements	m ³ /h	6400	7600	6400	7600	7600
Weight, approx.	kg	1780	1800	1860	1960	2060
Mechanical data for liquid-cooled cabinet units						
Frame size (dimensional drawing classification)		SW4	SW4	SW4	SW4	SW4
Sound pressure level L_{pA} (1 m) at 50/60 Hz	dB	75	75	75	75	75
Standard converter dimensions						
• Width	mm	3606	3606	3606	3606	3606
• Height	mm	2202	2202	2202	2202	2202
• Depth	mm	605	605	605	605	605
Coolant requirements	l/h	4000	4000	4000	4000	4000
Min. coolant pressure	bar	2.5	2.5	2.5	2.5	2.5
Max. coolant pressure	bar	6	6	6	6	6
Coolant test pressure	bar	10	10	10	10	10
Coolant pressure loss	bar	1.9	1.9	1.9	1.9	1.9
Min. coolant temperature	°C	10	10	10	10	10
Max. coolant temperature	°C	35	35	35	30	28
Weight, approx.	kg	1840	1860	1920	2020	2120

For footnotes, see next page.

SINAMICS G180

SINAMICS G180 cabinet units

SINAMICS G180 cabinet units
air-cooled and liquid-cooled

Technical data (continued)

Line voltage, supply system type		2 × 400, 415, 460, 500, 575, 690 V 3 AC IT				
SINAMICS G180 cabinet units – air-cooled		6SE0180-2CH41-2■A7	6SE0180-2CH41-3■A7	6SE0180-2CH41-5■A7	6SE0180-2CH41-7■A7	6SE0180-2CH42-0■A7
<i>Converter type</i> (air-cooled)		2T3F-87602-912	2T3F-87602-913	2T3F-87602-915	2T3F-87602-917	2T3F-87602-919
SINAMICS G180 cabinet units – liquid-cooled		6SE0170-2CH41-2■A7	6SE0170-2CH41-3■A7	6SE0170-2CH41-5■A7	6SE0170-2CH41-7■A7	6SE0170-2CH42-0■A7
<i>Converter type</i> (liquid-cooled)		2T6F-77602-912	2T6F-77602-913	2T6F-77602-915	2T6F-77602-917	2T6F-77602-919
General mechanical data						
Max. cable length between converter and motor with standard insulation (shielded)		m	100/250 ⁵⁾	100/250 ⁵⁾	100/250 ⁶⁾	100/250 ⁶⁾
Line/load connection						
L1, L2, L3/U2, V2, W2						
For connection cross-sections, see "Cable cross-sections and connections" in section "Configuring instructions"						
Approvals, according to			NRTL ⁷⁾	NRTL ⁷⁾	NRTL ⁷⁾	NRTL ⁷⁾

3

¹⁾ Rated power of a typical 2- to 6-pole standard motor.

²⁾ Typical output voltage dependent on filter and unit type.

³⁾ Maximum power loss with continuous motor current.

⁴⁾ With IP21 protective top cover (110 mm).

⁵⁾ Value is applicable with option L10 (strengthened dv/dt filter; filter is integrated in unit).

⁶⁾ Value is applicable with option L10 (strengthened dv/dt filter; filter is integrated in additional 2 × 600 mm cabinet).

⁷⁾ On request; the voltage range for NRTL units ends at max. 600 V.

SINAMICS G180

SINAMICS G180 cabinet units

SINAMICS G180 cabinet units air-cooled and liquid-cooled

Technical data (continued)

690 V, 12-pulse (continued)

Line voltage, supply system type		2 × 400, 415, 460, 500, 575, 690 V 3 AC IT				
SINAMICS G180 cabinet units – air-cooled		6SE0180-2DH42-2■A7	6SE0180-2DH42-4■A7	6SE0180-2DH42-7■A7	6SE0180-2DH43-0■A7	6SE0180-2EH43-2■A7
<i>Converter type</i> (air-cooled)		2T3F-87603-920	2T3F-87603-923	2T3F-87603-926	2T3F-87603-929	2T3F-87604-931
SINAMICS G180 cabinet units – liquid-cooled		6SE0170-2DH42-2■A7	6SE0170-2DH42-4■A7	6SE0170-2DH42-7■A7	6SE0170-2DH43-0■A7	6SE0170-2EH43-2■A7
<i>Converter type</i> (liquid-cooled)		2T6F-77603-920	2T6F-77603-923	2T6F-77603-926	2T6F-77603-929	2T6F-77604-931
Electrical data at motor end						
Type rating¹⁾						
• at 50 Hz 690 V	kW	2000	2300	2600	2900	3100
• at 60 Hz 575 V	hp	2235	2570	2906	3241	3465
Output voltage²⁾	V	0 ... 0.98 × V _{line}	0 ... 0.98 × V _{line}	0 ... 0.98 × V _{line}	0 ... 0.98 × V _{line}	0 ... 0.98 × V _{line}
Output current						
• Continuous current	A	2140	2400	2710	2970	3200
• Short-time current (60 s every 10 minutes) max.	A	2540	2800	3030	3230	3730
Overload capability (60 s every 10 minutes) max.	%	19	17	12	9	17
Output power	kVA	2558	2868	3239	3549	3824
Output frequency, max.	Hz	120	120	120	120	120
Rated clock cycle	kHz	2.4	2.4	2.4	2.4	2.4
adjustable from	kHz	1.5 ... 3.7	1.5 ... 3.7	1.5 ... 3.7	1.5 ... 3.7	1.5 ... 3.7
Power loss³⁾	kW	50.9	57.2	64.5	73.9	77.3
Rated efficiency	%	97.7	97.7	97.7	97.6	97.7
Electrical data at line end						
Connected load	kVA	2369	2648	2983	3272	3516
Rated input voltage	V	2 × 690	2 × 690	2 × 690	2 × 690	2 × 690
Input current						
• Continuous line current	A	2 × 991	2 × 1108	2 × 1248	2 × 1369	2 × 1471
• Short-time line current (60 s) max.	A	2 × 1176	2 × 1293	2 × 1395	2 × 1489	2 × 1715
Line fuse (provided by customer)	gL (A)	1250	1250	1500	1600	1800
λ_{line}		0.997	0.997	0.997	0.997	0.997
cos ϕ_{line}		1	1	1	1	1
Radio interference suppression acc. to EN 61800-3		C4	C4	C4	C4	C4
Mechanical data for air-cooled cabinet units						
Frame size (dimensional drawing classification)		SL7	SL7	SL7	SL7	SL8
Sound pressure level L_{pA} (1 m) at 50/60 Hz	dB	78	78	78	78	79
Standard converter dimensions						
• Width	mm	4806	4806	4806	4806	6406
• Height ⁴⁾	mm	2112	2112	2112	2112	2112
• Depth	mm	605	605	605	605	605
Coolant requirements	m ³ /h	11400	9600	11400	11400	12800
Weight, approx.	kg	2700	2790	2940	3090	3720
Mechanical data for liquid-cooled cabinet units						
Frame size (dimensional drawing classification)		SW7	SW7	SW7	SW7	SW8
Sound pressure level L_{pA} (1 m) at 50/60 Hz	dB	76	76	76	76	77
Standard converter dimensions						
• Width	mm	5206	5206	5206	5206	7006
• Height	mm	2202	2202	2202	2202	2202
• Depth	mm	605	605	605	605	605
Coolant requirements	l/h	6000	6000	6000	6000	8000
Min. coolant pressure	bar	2.5	2.5	2.5	2.5	2.5
Max. coolant pressure	bar	6	6	6	6	6
Coolant test pressure	bar	10	10	10	10	10
Coolant pressure loss	bar	1.9	1.9	1.9	1.9	1.9
Min. coolant temperature	°C	10	10	10	10	10
Max. coolant temperature	°C	35	35	30	28	35
Weight, approx.	kg	2750	2850	2850	3100	3850

For footnotes, see next page.

SINAMICS G180

SINAMICS G180 cabinet units

SINAMICS G180 cabinet units
air-cooled and liquid-cooled

Technical data (continued)

Line voltage, supply system type	2 × 400, 415, 460, 500, 575, 690 V 3 AC IT				
SINAMICS G180 cabinet units – air-cooled	6SE0180-2DH42-2■A7	6SE0180-2DH42-4■A7	6SE0180-2DH42-7■A7	6SE0180-2DH43-0■A7	6SE0180-2EH43-2■A7
<i>Converter type</i> (air-cooled)	2T3F-87603-920	2T3F-87603-923	2T3F-87603-926	2T3F-87603-929	2T3F-87604-931
SINAMICS G180 cabinet units – liquid-cooled	6SE0170-2DH42-2■A7	6SE0170-2DH42-4■A7	6SE0170-2DH42-7■A7	6SE0170-2DH43-0■A7	6SE0170-2EH43-2■A7
<i>Converter type</i> (liquid-cooled)	2T6F-77603-920	2T6F-77603-923	2T6F-77603-926	2T6F-77603-929	2T6F-77604-931
General mechanical data					
Max. cable length between converter and motor with standard insulation (shielded)	m	100/250 ⁵⁾	100/250 ⁶⁾	100/250 ⁶⁾	100/250 ⁷⁾
Line/load connection					
L1, L2, L3/U2, V2, W2					
For connection cross-sections, see "Cable cross-sections and connections" in section "Configuring instructions"					
Approvals, according to		NRTL ⁸⁾	NRTL ⁸⁾	NRTL ⁸⁾	NRTL ⁸⁾

3

1) Rated power of a typical 2- to 6-pole standard motor.

2) Typical output voltage dependent on filter and unit type.

3) Maximum power loss with continuous motor current.

4) With IP21 protective top cover (110 mm).

5) Value is applicable with option L10 (strengthened dv/dt filter; filter is integrated in unit).

6) Value is applicable with option L10 (strengthened dv/dt filter; filter is integrated in additional 3 × 600 mm cabinet).

7) Value is applicable with option L10 (strengthened dv/dt filter; filter is integrated in additional 4 × 600 mm cabinet).

8) On request; the voltage range for NRTL units ends at max. 600 V.

SINAMICS G180

SINAMICS G180 cabinet units

SINAMICS G180 cabinet units air-cooled and liquid-cooled

Technical data (continued)

690 V, 12-pulse (continued)

Line voltage, supply system type	2 × 400, 415, 460, 500, 575, 690 V 3 AC IT		
SINAMICS G180 cabinet units – air-cooled	6SE0180-2EH43-6■A7	6SE0180-2EH44-0■A7	
<i>Converter type</i> (air-cooled)	2T3F-87604-935	2T3F-87604-939	
SINAMICS G180 cabinet units – liquid-cooled	6SE0170-2EH43-6■A7	6SE0170-2EH44-0■A7	
<i>Converter type</i> (liquid-cooled)	2T6F-77604-935	2T6F-77604-939	
Electrical data at motor end			
Type rating¹⁾			
• at 50 Hz 690 V	kW	3500	3900
• at 60 Hz 575 V	hp	3912	4359
Output voltage²⁾	V	0 ... 0.98 × V _{line}	0 ... 0.98 × V _{line}
Output current			
• Continuous current	A	3610	3960
• Short-time current (60 s every 10 minutes) max.	A	4030	4300
Overload capability (60 s every 10 minutes) max.	%	12	9
Output power	kVA	4314	4732
Output frequency, max.	Hz	120	120
Rated clock cycle	kHz	2.4	2.4
adjustable from	kHz	1.5 ... 3.7	1.5 ... 3.7
Power loss³⁾	kW	87.3	99.7
Rated efficiency	%	97.7	97.6
Electrical data at line end			
Connected load	kVA	3956	4336
Rated input voltage	V	2 × 690	2 × 690
Input current			
• Continuous line current	A	2 × 1655	2 × 1814
• Short-time line current (60 s) max.	A	2 × 1848	2 × 1970
Line fuse (provided by customer)	gL (A)	2000	2000
λ_{line}		0.997	0.997
cos ϕ_{line}		1	1
Radio interference suppression acc. to EN 61800-3		C4	C4
Mechanical data for air-cooled cabinet units			
Frame size (dimensional drawing classification)	SL8	SL8	
Sound pressure level L_{pA} (1 m) at 50/60 Hz	dB	79	79
Standard converter dimensions			
• Width	mm	6406	6406
• Height ⁴⁾	mm	2112	2112
• Depth	mm	605	605
Coolant requirements	m ³ /h	15200	15200
Weight, approx.	kg	3920	4120
Mechanical data for liquid-cooled cabinet units			
Frame size (dimensional drawing classification)	SW8	SW8	
Sound pressure level L_{pA} (1 m) at 50/60 Hz	dB	77	77
Standard converter dimensions			
• Width	mm	7006	7006
• Height	mm	2202	2202
• Depth	mm	605	605
Coolant requirements	l/h	8000	8000
Min. coolant pressure	bar	2.5	2.5
Max. coolant pressure	bar	6	6
Coolant test pressure	bar	10	10
Coolant pressure loss	bar	1.9	1.9
Min. coolant temperature	°C	10	10
Max. coolant temperature	°C	30	28
Weight, approx.	kg	4050	4250

For footnotes, see next page.

SINAMICS G180

SINAMICS G180 cabinet units

SINAMICS G180 cabinet units
air-cooled and liquid-cooled

Technical data (continued)

Line voltage, supply system type	2 × 400, 415, 460, 500, 575, 690 V 3 AC IT	
SINAMICS G180 cabinet units – air-cooled	6SE0180-2EH43-6■A7	6SE0180-2EH44-0■A7
<i>Converter type</i> (air-cooled)	<i>2T3F-87604-935</i>	<i>2T3F-87604-939</i>
SINAMICS G180 cabinet units – liquid-cooled	6SE0170-2EH43-6■A7	6SE0170-2EH44-0■A7
<i>Converter type</i> (liquid-cooled)	<i>2T6F-77604-935</i>	<i>2T6F-77604-939</i>
General mechanical data		
Max. cable length between converter and motor with standard insulation (shielded)	m	100/250 ⁵⁾
Line/load connection		
L1, L2, L3/U2, V2, W2 For connection cross-sections, see "Cable cross-sections and connections" in section "Configuring instructions"		
Approvals, according to		NRTL ⁶⁾

3

1) Rated power of a typical 2- to 6-pole standard motor.
 2) Typical output voltage dependent on filter and unit type.
 3) Maximum power loss with continuous motor current.
 4) With IP21 protective top cover (110 mm).

5) Value is applicable with option L10 (strengthened dv/dt filter; filter is integrated in additional 4 × 600 mm cabinet).
 6) On request; the voltage range for NRTL units ends at max. 600 V.

SINAMICS G180

SINAMICS G180 cabinet units

SINAMICS G180 cabinet units air-cooled and liquid-cooled

Technical data (continued)

690 V, 18-pulse

Line voltage, supply system type		3 × 400, 415, 460, 500, 575, 690 V 3 AC IT				
SINAMICS G180 cabinet units – air-cooled		6SE0180-3DH42-2■A7 <i>2T3K-87603-920</i>	6SE0180-3DH42-4■A7 <i>2T3K-87603-923</i>	6SE0180-3DH42-7■A7 <i>2T3K-87603-926</i>	6SE0180-3DH43-0■A7 <i>2T3K-87603-929</i>	6SE0180-3HH44-3■A7 <i>2T3K-87606-941</i>
<i>Converter type</i> (air-cooled)						
SINAMICS G180 cabinet units – liquid-cooled		6SE0170-3DH42-2■A7 <i>2T6K-77603-920</i>	6SE0170-3DH42-4■A7 <i>2T6K-77603-923</i>	6SE0170-3DH42-7■A7 <i>2T6K-77603-926</i>	6SE0170-3DH43-0■A7 <i>2T6K-77603-929</i>	6SE0170-3HH44-3■A7 <i>2T6K-77606-941</i>
<i>Converter type</i> (liquid-cooled)						
Electrical data at motor end						
Type rating¹⁾						
• at 50 Hz 690 V	kW	2000	2300	2600	2900	4100
• at 60 Hz 575 V	hp	2235	2570	2906	3241	4582
Output voltage²⁾	V	0 ... 0.98 × V _{line}	0 ... 0.98 × V _{line}	0 ... 0.98 × V _{line}	0 ... 0.98 × V _{line}	0 ... 0.98 × V _{line}
Output current						
• Continuous current	A	2140	2400	2710	2970	4290
• Short-time current (60 s every 10 minutes) max.	A	2540	2800	3030	3230	5100
Overload capability (60 s every 10 minutes) max.	%	19	17	12	9	19
Output power	kVA	2558	2868	3239	3549	5127
Output frequency, max.	Hz	120	120	120	120	120
Rated clock cycle	kHz	2.4	2.4	2.4	2.4	2.4
adjustable from	kHz	1.5 ... 3.7	1.5 ... 3.7	1.5 ... 3.7	1.5 ... 3.7	1.5 ... 3.7
Power loss³⁾	kW	50.9	57.2	64.5	73.9	102
Rated efficiency	%	97.7	97.7	97.7	97.6	97.7
Electrical data at line end						
Connected load	kVA	2369	2648	2983	3272	4692
Rated input voltage	V	3 × 690	3 × 690	3 × 690	3 × 690	3 × 690
Input current						
• Continuous line current	A	3 × 661	3 × 739	3 × 832	3 × 912	3 × 1308
• Short-time line current (60 s) max.	A	3 × 785	3 × 862	3 × 930	3 × 992	3 × 1555
Line fuse (provided by customer)	gL (A)	800	900	1000	1250	1500
λ_{line}		1	1	1	1	1
cos ϕ_{line}		1	1	1	1	1
Radio interference suppression acc. to EN 61800-3		C4	C4	C4	C4	C4
Mechanical data for air-cooled cabinet units						
Frame size (dimensional drawing classification)		SL7	SL7	SL7	SL7	SL11
Sound pressure level L_{pA} (1 m) at 50/60 Hz	dB	78	78	78	78	79
Standard converter dimensions						
• Width	mm	4806	4806	4806	4806	10206
• Height ⁴⁾	mm	2112	2112	2112	2112	2112
• Depth	mm	605	605	605	605	605
Coolant requirements	m ³ /h	11400	9600	11400	11400	23150
Weight, approx.	kg	2750	2840	2990	3140	5750
Mechanical data for liquid-cooled cabinet units						
Frame size (dimensional drawing classification)		SW7	SW7	SW7	SW7	⁵⁾
Sound pressure level L_{pA} (1 m) at 50/60 Hz	dB	76	76	76	76	77
Standard converter dimensions						
• Width	mm	5206	5206	5206	5206	⁵⁾
• Height	mm	2202	2202	2202	2202	⁵⁾
• Depth	mm	605	605	605	605	⁵⁾
Coolant requirements	l/h	6000	6000	6000	6000	12000
Min. coolant pressure	bar	2.5	2.5	2.5	2.5	2.5
Max. coolant pressure	bar	6	6	6	6	6
Coolant test pressure	bar	10	10	10	10	10
Coolant pressure loss	bar	1.9	1.9	1.9	1.9	1.9
Min. coolant temperature	°C	10	10	10	10	10
Max. coolant temperature	°C	35	35	30	28	35
Weight, approx.	kg	2830	2920	3070	3220	5910

For footnotes, see next page.

SINAMICS G180

SINAMICS G180 cabinet units

SINAMICS G180 cabinet units
air-cooled and liquid-cooled

Technical data (continued)

Line voltage, supply system type	3 × 400, 415, 460, 500, 575, 690 V 3 AC IT				
SINAMICS G180 cabinet units – air-cooled	6SE0180-3DH42-2■A7	6SE0180-3DH42-4■A7	6SE0180-3DH42-7■A7	6SE0180-3DH43-0■A7	6SE0180-3HH44-3■A7
<i>Converter type</i> (air-cooled)	2T3K-87603-920	2T3K-87603-923	2T3K-87603-926	2T3K-87603-929	2T3K-87606-941
SINAMICS G180 cabinet units – liquid-cooled	6SE0170-3DH42-2■A7	6SE0170-3DH42-4■A7	6SE0170-3DH42-7■A7	6SE0170-3DH43-0■A7	6SE0170-3HH44-3■A7
<i>Converter type</i> (liquid-cooled)	2T6K-77603-920	2T6K-77603-923	2T6K-77603-926	2T6K-77603-929	2T6K-77606-941
General mechanical data					
Max. cable length between converter and motor with standard insulation (shielded)	m	100/250 ⁶⁾	100/250 ⁷⁾	100/250 ⁷⁾	100/250 ⁶⁾
Line/load connection					
L1, L2, L3/U2, V2, W2					
For connection cross-sections, see "Cable cross-sections and connections" in section "Configuring instructions"					
Approvals, according to		NRTL ⁸⁾	NRTL ⁸⁾	NRTL ⁸⁾	NRTL ⁸⁾

3

1) Rated power of a typical 2- to 6-pole standard motor.
 2) Typical output voltage dependent on filter and unit type.
 3) Maximum power loss with continuous motor current.
 4) With IP21 protective top cover (110 mm).
 5) Dimensions on request.

6) Value is applicable with option L10 (strengthened dv/dt filter; filter is integrated in unit).
 7) Value is applicable with option L10 (strengthened dv/dt filter; filter is integrated in additional 3 × 600 mm cabinet).
 8) On request; the voltage range for NRTL units ends at max. 600 V.

SINAMICS G180

SINAMICS G180 cabinet units

SINAMICS G180 cabinet units air-cooled and liquid-cooled

Technical data (continued)

690 V, 18-pulse (continued)

Line voltage, supply system type		3 × 400, 415, 460, 500, 575, 690 V 3 AC IT		
SINAMICS G180 cabinet units – air-cooled		6SE0180-3HH44-8■A7 <i>2T3K-87606-947</i>	6SE0180-3HH45-4■A7 <i>2T3K-87606-953</i>	6SE0180-3HH46-0■A7 <i>2T3K-87606-958</i>
<i>Converter type</i> (air-cooled)				
SINAMICS G180 cabinet units – liquid-cooled		6SE0170-3HH44-8■A7 <i>2T6K-77606-947</i>	6SE0170-3HH45-4■A7 <i>2T6K-77606-953</i>	6SE0170-3HH46-0■A7 <i>2T6K-77606-958</i>
<i>Converter type</i> (liquid-cooled)				
Electrical data at motor end				
Type rating¹⁾				
• at 50 Hz 690 V	kW	4700	5300	5800
• at 60 Hz 575 V	hp	5253	5923	6482
Output voltage²⁾	V	0 ... 0.98 × V _{line}	0 ... 0.98 × V _{line}	0 ... 0.98 × V _{line}
Output current				
• Continuous current	A	4800	5420	5940
• Short-time current (60 s every 10 minutes) max.	A	5610	6040	6450
Overload capability (60 s every 10 minutes) max.	%	17	11	9
Output power	kVA	5736	6477	7099
Output frequency, max.	Hz	120	120	120
Rated clock cycle	kHz	2.4	2.4	2.4
adjustable from	kHz	1.5 ... 3.7	1.5 ... 3.7	1.5 ... 3.7
Power loss³⁾	kW	110	118	129
Rated efficiency	%	97.8	97.9	97.9
Electrical data at line end				
Connected load	kVA	5244	5916	6482
Rated input voltage	V	3 × 690	3 × 690	3 × 690
Input current				
• Continuous line current	A	3 × 1462	3 × 1651	3 × 1809
• Short-time line current (60 s) max.	A	3 × 1709	3 × 1840	3 × 1964
Line fuse (provided by customer)	gL (A)	1800	2000	2000 ... 2500
λ_{line}		1	1	1
cos ϕ_{line}		1	1	1
Radio interference suppression acc. to EN 61800-3		C4	C4	C4
Mechanical data for air-cooled cabinet units				
Frame size (dimensional drawing classification)		SL11	SL11	SL11
Sound pressure level L_{pA} (1 m) at 50/60 Hz	dB	79	79	79
Standard converter dimensions				
• Width	mm	10206	10206	10206
• Height ⁴⁾	mm	2112	2112	2112
• Depth	mm	605	605	605
Coolant requirements	m ³ /h	19550	23150	23150
Weight, approx.	kg	5930	6230	6530
Mechanical data for liquid-cooled cabinet units				
Frame size (dimensional drawing classification)		_5)	_5)	_5)
Sound pressure level L_{pA} (1 m) at 50/60 Hz	dB	77	77	77
Standard converter dimensions				
• Width	mm	_5)	_5)	_5)
• Height	mm	_5)	_5)	_5)
• Depth	mm	_5)	_5)	_5)
Coolant requirements	l/h	12000	12000	12000
Min. coolant pressure	bar	2.5	2.5	2.5
Max. coolant pressure	bar	6	6	6
Coolant test pressure	bar	10	10	10
Coolant pressure loss	bar	1.9	1.9	1.9
Min. coolant temperature	°C	10	10	10
Max. coolant temperature	°C	38	30	28
Weight, approx.	kg	6090	6390	6690

For footnotes, see next page.

SINAMICS G180

SINAMICS G180 cabinet units

SINAMICS G180 cabinet units
air-cooled and liquid-cooled

Technical data (continued)

Line voltage, supply system type	3 × 400, 415, 460, 500, 575, 690 V 3 AC IT		
SINAMICS G180 cabinet units – air-cooled	6SE0180-3HH44-8■A7	6SE0180-3HH45-4■A7	6SE0180-3HH46-0■A7
<i>Converter type</i> (air-cooled)	2T3K-87606-947	2T3K-87606-953	2T3K-87606-958
SINAMICS G180 cabinet units – liquid-cooled	6SE0170-3HH44-8■A7	6SE0170-3HH45-4■A7	6SE0170-3HH46-0■A7
<i>Converter type</i> (liquid-cooled)	2T6K-77606-947	2T6K-77606-953	2T6K-77606-958
General mechanical data			
Max. cable length between converter and motor with standard insulation (shielded)	m	100/250 ⁶⁾	100/250 ⁶⁾
Line/load connection			
L1, L2, L3/U2, V2, W2 For connection cross-sections, see "Cable cross-sections and connections" in section "Configuring instructions"			
Approvals, according to		NRTL ⁷⁾	NRTL ⁷⁾

3

1) Rated power of a typical 2- to 6-pole standard motor.
 2) Typical output voltage dependent on filter and unit type.
 3) Maximum power loss with continuous motor current.
 4) With IP21 protective top cover (110 mm).
 5) Dimensions on request.

6) Value is applicable with option L10 (strengthened dv/dt filter; filter is integrated in additional 6 × 600 mm cabinet).
 7) On request; the voltage range for NRTL units ends at max. 600 V.

SINAMICS G180

SINAMICS G180 cabinet units

SINAMICS G180 cabinet units air-cooled and liquid-cooled

Technical data (continued)

690 V, 24-pulse

Line voltage, supply system type		4 × 400, 415, 460, 500, 575, 690 V 3 AC IT				
SINAMICS G180 cabinet units – air-cooled		6SE0180-4CH41-2■A7	6SE0180-4CH41-3■A7	6SE0180-4CH41-5■A7	6SE0180-4CH41-7■A7	6SE0180-4CH42-0■A7
<i>Converter type</i> (air-cooled)		2T3L-87602-912	2T3L-87602-913	2T3L-87602-915	2T3L-87602-917	2T3L-87602-919
SINAMICS G180 cabinet units – liquid-cooled		6SE0170-4CH41-2■A7	6SE0170-4CH41-3■A7	6SE0170-4CH41-5■A7	6SE0170-4CH41-7■A7	6SE0170-4CH42-0■A7
<i>Converter type</i> (liquid-cooled)		2T6L-77602-912	2T6L-77602-913	2T6L-77602-915	2T6L-77602-917	2T6L-77602-919
Electrical data at motor end						
Type rating¹⁾						
• at 50 Hz 690 V	kW	1200	1300	1500	1700	1900
• at 60 Hz 575 V	hp	1341	1453	1676	1900	2123
Output voltage²⁾	V	0 ... 0.98 × V _{line}	0 ... 0.98 × V _{line}	0 ... 0.98 × V _{line}	0 ... 0.98 × V _{line}	0 ... 0.98 × V _{line}
Output current						
• Continuous current	A	1260	1430	1600	1810	1980
• Short-time current (60 s every 10 minutes) max.	A	1520	1700	1870	2020	2150
Overload capability (60 s every 10 minutes) max.	%	21	19	17	12	9
Output power	kVA	1506	1709	1912	2163	2366
Output frequency, max.	Hz	120	120	120	120	120
Rated clock cycle	kHz	2.4	2.4	2.4	2.4	2.4
adjustable from	kHz	1.5 ... 3.7	1.5 ... 3.7	1.5 ... 3.7	1.5 ... 3.7	1.5 ... 3.7
Power loss³⁾	kW	28.2	33.6	37.5	42.6	46.5
Rated efficiency	%	97.8	97.7	97.7	97.7	97.7
Electrical data at line end						
Connected load	kVA	1405	1597	1781	2010	2194
Rated input voltage	V	4 × 690	4 × 690	4 × 690	4 × 690	4 × 690
Input current						
• Continuous line current	A	4 × 294	4 × 333	4 × 372	4 × 421	4 × 459
• Short-time line current (60 s) max.	A	4 × 355	4 × 396	4 × 435	4 × 470	4 × 498
Line fuse (provided by customer)	gL (A)	400	400	500	500	630
λ_{line}		1	1	1	1	1
cos ϕ_{line}		1	1	1	1	1
Radio interference suppression acc. to EN 61800-3		C4	C4	C4	C4	C4
Mechanical data for air-cooled cabinet units						
Frame size (dimensional drawing classification)		SL9	SL9	SL9	SL9	SL9
Sound pressure level L_{pA} (1 m) at 50/60 Hz	dB	77	77	77	77	77
Standard converter dimensions						
• Width	mm	3606	3606	3606	3606	3606
• Height ⁴⁾	mm	2112	2112	2112	2112	2112
• Depth	mm	605	605	605	605	605
Coolant requirements	m ³ /h	6400	7600	6400	7600	7600
Weight, approx.	kg	1830	1850	1910	2010	2110
Mechanical data for liquid-cooled cabinet units						
Frame size (dimensional drawing classification)		SW9	SW9	SW9	SW9	SW9
Sound pressure level L_{pA} (1 m) at 50/60 Hz	dB	75	75	75	75	75
Standard converter dimensions						
• Width	mm	4406	4406	4406	4406	4406
• Height	mm	2202	2202	2202	2202	2202
• Depth	mm	605	605	605	605	605
Coolant requirements	l/h	4000	4000	4000	4000	4000
Min. coolant pressure	bar	2.5	2.5	2.5	2.5	2.5
Max. coolant pressure	bar	6	6	6	6	6
Coolant test pressure	bar	10	10	10	10	10
Coolant pressure loss	bar	1.9	1.9	1.9	1.9	1.9
Min. coolant temperature	°C	10	10	10	10	10
Max. coolant temperature	°C	35	35	35	30	28
Weight, approx.	kg	1930	1950	2010	2100	2160

For footnotes, see next page.

SINAMICS G180

SINAMICS G180 cabinet units

SINAMICS G180 cabinet units
air-cooled and liquid-cooled

Technical data (continued)

Line voltage, supply system type	4 × 400, 415, 460, 500, 575, 690 V 3 AC IT					
SINAMICS G180 cabinet units – air-cooled	6SE0180-4CH41-2■A7	6SE0180-4CH41-3■A7	6SE0180-4CH41-5■A7	6SE0180-4CH41-7■A7	6SE0180-4CH42-0■A7	
<i>Converter type</i> (air-cooled)	2T3L-87602-912	2T3L-87602-913	2T3L-87602-915	2T3L-87602-917	2T3L-87602-919	
SINAMICS G180 cabinet units – liquid-cooled	6SE0170-4CH41-2■A7	6SE0170-4CH41-3■A7	6SE0170-4CH41-5■A7	6SE0170-4CH41-7■A7	6SE0170-4CH42-0■A7	
<i>Converter type</i> (liquid-cooled)	2T6L-77602-912	2T6L-77602-913	2T6L-77602-915	2T6L-77602-917	2T6L-77602-919	
General mechanical data						
Max. cable length between converter and motor with standard insulation (shielded)	m	100/250 ⁵⁾	100/250 ⁵⁾	100/250 ⁶⁾	100/250 ⁶⁾	100/250 ⁶⁾
Line/load connection						
L1, L2, L3/U2, V2, W2						
For connection cross-sections, see "Cable cross-sections and connections" in section "Configuring instructions"						
Approvals, according to		NRTL ⁷⁾	NRTL ⁷⁾	NRTL ⁷⁾	NRTL ⁷⁾	NRTL ⁷⁾

¹⁾ Rated power of a typical 2- to 6-pole standard motor.

²⁾ Typical output voltage dependent on filter and unit type.

³⁾ Maximum power loss with continuous motor current.

⁴⁾ With IP21 protective top cover (110 mm).

⁵⁾ Value is applicable with option L10 (strengthened dv/dt filter; filter is integrated in unit).

⁶⁾ Value is applicable with option L10 (strengthened dv/dt filter; filter is integrated in additional 600 mm cabinet).

⁷⁾ On request; the voltage range for NRTL units ends at max. 600 V.

SINAMICS G180

SINAMICS G180 cabinet units

SINAMICS G180 cabinet units air-cooled and liquid-cooled

Technical data (continued)

690 V, 24-pulse (continued)

Line voltage, supply system type		4 × 400, 415, 460, 500, 575, 690 V 3 AC IT				
SINAMICS G180 cabinet units – air-cooled		6SE0180-4EH43-2■A7 <i>2T3L-87604-931</i>	6SE0180-4EH43-6■A7 <i>2T3L-87604-935</i>	6SE0180-4EH44-0■A7 <i>2T3L-87604-939</i>	6SE0180-4HH44-3■A7 <i>2T3L-87606-941</i>	6SE0180-4HH44-8■A7 <i>2T3L-87606-947</i>
<i>Converter type</i> (air-cooled)						
SINAMICS G180 cabinet units – liquid-cooled		6SE0170-4EH43-2■A7 <i>2T6L-77604-931</i>	6SE0170-4EH43-6■A7 <i>2T6L-77604-935</i>	6SE0170-4EH44-0■A7 <i>2T6L-77604-939</i>	6SE0170-4HH44-3■A7 <i>2T6L-77606-941</i>	6SE0170-4HH44-8■A7 <i>2T6L-77606-947</i>
<i>Converter type</i> (liquid-cooled)						
Electrical data at motor end						
Type rating¹⁾						
• at 50 Hz 690 V	kW	3100	3500	3900	4100	4700
• at 60 Hz 575 V	hp	3465	3912	4359	4582	5253
Output voltage²⁾	V	0 ... 0.98 × V _{line}	0 ... 0.98 × V _{line}	0 ... 0.98 × V _{line}	0 ... 0.98 × V _{line}	0 ... 0.98 × V _{line}
Output current						
• Continuous current	A	3200	3610	3960	4290	4800
• Short-time current (60 s every 10 minutes) max.	A	3730	4030	4300	5100	5610
Overload capability (60 s every 10 minutes) max.	%	17	12	9	19	17
Output power	kVA	3824	4314	4732	5127	5736
Output frequency, max.	Hz	120	120	120	120	120
Rated clock cycle	kHz	2.4	2.4	2.4	2.4	2.4
adjustable from	kHz	1.5 ... 3.7	1.5 ... 3.7	1.5 ... 3.7	1.5 ... 3.7	1.5 ... 3.7
Power loss³⁾	kW	77.3	87.3	99.7	102	110
Rated efficiency	%	97.7	97.7	97.6	97.7	97.8
Electrical data at line end						
Connected load	kVA	3516	3956	4336	4692	5244
Rated input voltage	V	4 × 690	4 × 690	4 × 690	4 × 690	4 × 690
Input current						
• Continuous line current	A	4 × 735	4 × 828	4 × 906	4 × 982	4 × 1098
• Short-time line current (60 s) max.	A	4 × 857	4 × 924	4 × 984	4 × 1167	4 × 1283
Line fuse (provided by customer)	gL (A)	900	1000	1000 ... 1250	1250	1250 ... 1500
λ_{line}		1	1	1	1	1
cos ϕ_{line}		1	1	1	1	1
Radio interference suppression acc. to EN 61800-3		C4	C4	C4	C4	C4
Mechanical data for air-cooled cabinet units						
Frame size (dimensional drawing classification)		SL10	SL10	SL10	SL12	SL12
Sound pressure level L_{pA} (1 m) at 50/60 Hz	dB	79	79	79	79	79
Standard converter dimensions						
• Width	mm	7206	7206	7206	11406	11406
• Height ⁴⁾	mm	2112	2112	2112	2112	2112
• Depth	mm	605	605	605	605	605
Coolant requirements	m ³ /h	12800	15200	15200	23150	19550
Weight, approx.	kg	3760	3970	4170	5750	5930
Mechanical data for liquid-cooled cabinet units						
Frame size (dimensional drawing classification)		SW10	SW10	SW10	_5)	_5)
Sound pressure level L_{pA} (1 m) at 50/60 Hz	dB	77	77	77	77	77
Standard converter dimensions						
• Width	mm	7806	7806	7806	_5)	_5)
• Height	mm	2202	2202	2202	_5)	_5)
• Depth	mm	605	605	605	_5)	_5)
Coolant requirements	l/h	8000	8000	8000	12000	12000
Min. coolant pressure	bar	2.5	2.5	2.5	2.5	2.5
Max. coolant pressure	bar	6	6	6	6	6
Coolant test pressure	bar	10	10	10	10	10
Coolant pressure loss	bar	1.9	1.9	1.9	1.9	1.9
Min. coolant temperature	°C	10	10	10	10	10
Max. coolant temperature	°C	35	30	28	35	38
Weight, approx.	kg	3860	4070	4270	5910	6090

For footnotes, see next page.

SINAMICS G180

SINAMICS G180 cabinet units

SINAMICS G180 cabinet units
air-cooled and liquid-cooled

Technical data (continued)

Line voltage, supply system type	4 × 400, 415, 460, 500, 575, 690 V 3 AC IT				
SINAMICS G180 cabinet units – air-cooled	6SE0180-4EH43-2■A7	6SE0180-4EH43-6■A7	6SE0180-4EH44-0■A7	6SE0180-4HH44-3■A7	6SE0180-4HH44-8■A7
<i>Converter type</i> (air-cooled)	<i>2T3L-87604-931</i>	<i>2T3L-87604-935</i>	<i>2T3L-87604-939</i>	<i>2T3L-87606-941</i>	<i>2T3L-87606-947</i>
SINAMICS G180 cabinet units – liquid-cooled	6SE0170-4EH43-2■A7	6SE0170-4EH43-6■A7	6SE0170-4EH44-0■A7	6SE0170-4HH44-3■A7	6SE0170-4HH44-8■A7
<i>Converter type</i> (liquid-cooled)	<i>2T6L-77604-931</i>	<i>2T6L-77604-935</i>	<i>2T6L-77604-939</i>	<i>2T6L-77606-941</i>	<i>2T6L-77606-947</i>
General mechanical data					
Max. cable length between converter and motor with standard insulation (shielded)	m	100/250 ⁶⁾	100/250 ⁶⁾	100/250 ⁶⁾	100/250 ⁷⁾
Line/load connection					
L1, L2, L3/U2, V2, W2					
For connection cross-sections, see "Cable cross-sections and connections" in section "Configuring instructions"					
Approvals, according to		NRTL ⁹⁾	NRTL ⁹⁾	NRTL ⁹⁾	NRTL ⁹⁾

3

¹⁾ Rated power of a typical 2- to 6-pole standard motor.

²⁾ Typical output voltage dependent on filter and unit type.

³⁾ Maximum power loss with continuous motor current.

⁴⁾ With IP21 protective top cover (110 mm).

⁵⁾ Dimensions on request.

⁶⁾ With option L10 (strengthened dv/dt filter) the filter is integrated in additional 4 × 600 mm cabinet.

⁷⁾ Value is applicable with option L10 (strengthened dv/dt filter; filter is integrated in unit).

⁸⁾ Value is applicable with option L10 (strengthened dv/dt filter; filter is integrated in additional 6 × 600 mm cabinet).

⁹⁾ On request; the voltage range for NRTL units ends at max. 600 V.

SINAMICS G180

SINAMICS G180 cabinet units

SINAMICS G180 cabinet units air-cooled and liquid-cooled

Technical data (continued)

690 V, 24-pulse (continued)

Line voltage, supply system type		4 × 400, 415, 460, 500, 575, 690 V 3 AC IT	
SINAMICS G180 cabinet units – air-cooled		6SE0180-4HH45-4■A7	6SE0180-4HH46-0■A7
<i>Converter type</i> (air-cooled)		<i>2T3L-87606-953</i>	<i>2T3L-87606-958</i>
SINAMICS G180 cabinet units – liquid-cooled		6SE0170-4HH45-4■A7	6SE0170-4HH46-0■A7
<i>Converter type</i> (liquid-cooled)		<i>2T6L-77606-953</i>	<i>2T6L-77606-958</i>
Electrical data at motor end			
Type rating¹⁾			
• at 50 Hz 690 V	kW	5300	5800
• at 60 Hz 575 V	hp	5923	6482
Output voltage²⁾	V	0 ... 0.98 × V _{line}	0 ... 0.98 × V _{line}
Output current			
• Continuous current	A	5420	5940
• Short-time current (60 s every 10 minutes) max.	A	6040	6450
Overload capability (60 s every 10 minutes) max.	%	11	9
Output power	kVA	6477	7099
Output frequency, max.	Hz	120	120
Rated clock cycle	kHz	2.4	2.4
adjustable from	kHz	1.5 ... 3.7	1.5 ... 3.7
Power loss³⁾	kW	118	129
Rated efficiency	%	97.9	97.9
Electrical data at line end			
Connected load	kVA	5916	6482
Rated input voltage	V	4 × 690	4 × 690
Input current			
• Continuous line current	A	4 × 1237	4 × 1357
• Short-time line current (60 s) max.	A	4 × 1378	4 × 1474
Line fuse (provided by customer)	gL (A)	1500	1500 ... 1800
λ_{line}		1	1
Cos ϕ_{line}		1	1
Radio interference suppression acc. to EN 61800-3		C4	C4
Mechanical data for air-cooled cabinet units			
Frame size (dimensional drawing classification)		SL12	SL12
Sound pressure level L_{pA} (1 m) at 50/60 Hz	dB	79	79
Standard converter dimensions			
• Width	mm	11406	11406
• Height ⁴⁾	mm	2112	2112
• Depth	mm	605	605
Coolant requirements	m ³ /h	23150	23150
Weight, approx.	kg	6230	6530
Mechanical data for liquid-cooled cabinet units			
Frame size (dimensional drawing classification)		_5)	_5)
Sound pressure level L_{pA} (1 m) at 50/60 Hz	dB	77	77
Standard converter dimensions			
• Width	mm	_5)	_5)
• Height	mm	_5)	_5)
• Depth	mm	_5)	_5)
Coolant requirements	l/h	12000	12000
Min. coolant pressure	bar	2.5	2.5
Max. coolant pressure	bar	6	6
Coolant test pressure	bar	10	10
Coolant pressure loss	bar	1.9	1.9
Min. coolant temperature	°C	10	10
Max. coolant temperature	°C	30	28
Weight, approx.	kg	6390	6690

For footnotes, see next page.

SINAMICS G180

SINAMICS G180 cabinet units

SINAMICS G180 cabinet units
air-cooled and liquid-cooled

Technical data (continued)

Line voltage, supply system type	4 × 400, 415, 460, 500, 575, 690 V 3 AC IT	
SINAMICS G180 cabinet units – air-cooled	6SE0180-4HH45-4■A7	6SE0180-4HH46-0■A7
<i>Converter type</i> (air-cooled)	<i>2T3L-87606-953</i>	<i>2T3L-87606-958</i>
SINAMICS G180 cabinet units – liquid-cooled	6SE0170-4HH45-4■A7	6SE0170-4HH46-0■A7
<i>Converter type</i> (liquid-cooled)	<i>2T6L-77606-953</i>	<i>2T6L-77606-958</i>
General mechanical data		
Max. cable length between converter and motor with standard insulation (shielded)	m	100/250 ⁶⁾
Line/load connection		
L1, L2, L3/U2, V2, W2 For connection cross-sections, see "Cable cross-sections and connections" in section "Configuring instructions"		
Approvals, according to	NRTL ⁷⁾	NRTL ⁷⁾

3

1) Rated power of a typical 2- to 6-pole standard motor.
 2) Typical output voltage dependent on filter and unit type.
 3) Maximum power loss with continuous motor current.
 4) With IP21 protective top cover (110 mm).
 5) Dimensions on request.

6) Value is applicable with option L10 (strengthened dv/dt filter; filter is integrated in additional 6 × 600 mm cabinet).
 7) On request; the voltage range for NRTL units ends at max. 600 V.

SINAMICS G180

SINAMICS G180 cabinet units

SINAMICS G180 cabinet units
air-cooled and liquid-cooled

Selection and ordering data

Article number code

Position of Article No.	1	2	3	4	5	6	7	8	9	10	11	12	13	14	15	16		
SINAMICS G180 cabinet units	6	S	E	0	1	.	0	-	.	.	■	.	.	-	.	■	A	.
Mechanical design																		
Liquid-cooled cabinet unit						7												
Air-cooled cabinet unit						8												
Line harmonics																		
6-pulse								1										
12-pulse								2										
18-pulse								3										
24-pulse								4										
Number of parallel connected systems																		
Single device with system management										B								
Multiple device with 2 parallel circuits										C								
Multiple device with 3 parallel circuits										D								
Multiple device with 4 parallel circuits										E								
Multiple device with 5 parallel circuits										G								
Multiple device with 6 parallel circuits										H								
Multiple device with 7 parallel circuits										J								
Supply voltage																		
230 ... 415 V 3 AC TN/TT, 50 ... 60 Hz										A								
230 ... 415 V 3 AC IT, 50 ... 60 Hz										B								
230 ... 500 V 3 AC TN/TT, 50 ... 60 Hz										C								
230 ... 500 V 3 AC IT, 50 ... 60 Hz										D								
400 ... 600/690 V 3 AC ¹⁾ TN/TT, 50 ... 60 Hz										G								
400 ... 600/690 V 3 AC ¹⁾ IT, 50 ... 60 Hz										H								
Option module																		
IEC, EN																	A	
NRTL-certified according to UL 508C ²⁾ (by TÜV and/or UL)																	U	
Version/release number																		
Version/release number T7																		7

¹⁾ With an NRTL unit ("U" in 14th position of article number), the voltage range ends at maximum 600 V, otherwise at 690 V.

²⁾ Not yet available, on request.

SINAMICS G180

SINAMICS G180 cabinet units

SINAMICS G180 cabinet units
air-cooled and liquid-cooled

Selection and ordering data (continued)

Number code for converter type

Position of <i>converter type</i> No.	1	2	3	4	5	6	7	8	9	10	11	12
SINAMICS G180 cabinet units	2	T	.	.	-	-	.	.
Degree of protection												
IP21			3									
IP54			6									
IP55			7									
Different degree of protection			9									
Number of pulses in the input												
6-pulse input				A								
12-pulse input				F								
18-pulse input				K								
24-pulse input				L								
Mechanical design												
Liquid-cooled cabinet unit					7							
Air-cooled cabinet unit					8							
Modification status												
Modification status 7						7						
Line voltage												
400 V unit							4					
500 V unit							5					
690 V unit							6					
Number of parallel line-converter systems												
Single device without system management									0			
Number of parallel machine-converter systems												
Single device without system management									0			
Single device with system management									1			
Multiple device with corresponding number of parallel systems and system management units									2			
									...			
									7			
Achievable type rating in kW with continuous output current												
If the 10th position of the type number is "9", the other two digits show the output in kW × 100.										.	.	.

SINAMICS G180

SINAMICS G180 cabinet units

SINAMICS G180 cabinet units air-cooled and liquid-cooled

Options

The following tables provide an overview of the options and their availability for SINAMICS G180 cabinet units with a supply voltage of 400 V, 500 V or 690 V. (For details, see catalog chapter 4 "Option descriptions".)

Option text	Additional ordering data -Z with order code and, if necessary, with plain text specification	Air-cooled and liquid-cooled versions of SINAMICS G180 cabinet units														
		400 V					500 V					690 V				
		Pulse number 6					12					6				
Version – see selection and ordering data																
A B C D E F G H I J K L M N O																
Line voltages																
Line voltage 380 V, 50 Hz	V70	✓	✓	✓	✓	✓	✓	✓	✓	–	–	–	–	–	–	–
Line voltage 400 V, 50 Hz	V71	□	□	□	□	□	✓	✓	✓	✓	✓	✓	✓	✓	✓	✓
Line voltage 415 V, 50 Hz	V72	✓	✓	✓	✓	✓	✓	✓	✓	✓	✓	✓	✓	✓	✓	✓
Line voltage 500 V, 50 Hz	V73	–	–	–	–	–	–	–	–	–	–	–	–	–	–	–
Line voltage 660 V, 50 Hz	V74	–	–	–	–	–	–	–	–	–	–	–	–	–	–	–
Line voltage 690 V, 50 Hz	V75	–	–	–	–	–	–	–	–	–	–	–	–	–	–	–
Line voltage 440 V, 60 Hz	V76	–	–	–	–	–	–	–	–	–	–	–	–	–	–	–
Line voltage 460 V, 60 Hz	V77	–	–	–	–	–	–	–	–	–	–	–	–	–	–	–
Line voltage 480 V, 60 Hz	V78	–	–	–	–	–	–	–	–	–	–	–	–	–	–	–
Line voltage 600 V, 60 Hz	V79	–	–	–	–	–	–	–	–	–	–	–	–	–	–	–
Line voltage 660 V, 60 Hz	V80	–	–	–	–	–	–	–	–	–	–	–	–	–	–	–
Special line voltage; please specify voltage	Y70 • and identification code	✓ ¹⁾	✓ ¹⁾	✓ ¹⁾	✓ ¹⁾	✓ ¹⁾	✓ ²⁾	✓ ²⁾	✓ ²⁾	✓ ³⁾	✓ ³⁾	✓ ³⁾	✓ ³⁾	✓ ³⁾	✓ ³⁾	✓ ³⁾
Additional cabinet																
400 mm	H90	✓	✓	✓	✓	✓	✓	✓	✓	✓	✓	✓	✓	✓	✓	✓
600 mm	H91	✓	✓	✓	✓	✓	✓	✓	✓	✓	✓	✓	✓	✓	✓	✓
800 mm	H92	✓	✓	✓	✓	✓	✓	✓	✓	✓	✓	✓	✓	✓	✓	✓
1000 mm	H93	✓	✓	✓	✓	✓	✓	✓	✓	✓	✓	✓	✓	✓	✓	✓
1200 mm	H94	✓	✓	✓	✓	✓	✓	✓	✓	✓	✓	✓	✓	✓	✓	✓
External auxiliary power supply																
Connection for 230 V 1 AC 50 Hz auxiliary voltage provided by customer	C36	✓	✓	✓	✓	✓	✓	✓	✓	✓	✓	✓	✓	✓	✓	✓
Connection for 400 V 3 AC 50 Hz auxiliary voltage provided by customer	C38	✓	✓	✓	✓	✓	✓	✓	✓	✓	✓	✓	✓	✓	✓	✓
Connection for 500 V 3 AC 50 Hz auxiliary voltage provided by customer	C43	✓	✓	✓	✓	✓	✓	✓	✓	✓	✓	✓	✓	✓	✓	✓
Connection for 690 V 3 AC 50 Hz auxiliary voltage provided by customer	C48	✓	✓	✓	✓	✓	✓	✓	✓	✓	✓	✓	✓	✓	✓	✓
Connection for other 3 AC voltage provided by customer; please specify voltage	Y36 • and identification code	✓	✓	✓	✓	✓	✓	✓	✓	✓	✓	✓	✓	✓	✓	✓
External control voltage supply																
Connection for 230 V 1 AC 50 Hz control voltage provided by customer, without UPS backup	C56	✓	✓	✓	✓	✓	✓	✓	✓	✓	✓	✓	✓	✓	✓	✓
Connection for 230 V 1 AC 50 Hz control voltage provided by customer, with UPS backup	C57	✓	✓	✓	✓	✓	✓	✓	✓	✓	✓	✓	✓	✓	✓	✓
Connection for different 1 AC control voltage (47 to 63 Hz) provided by customer; please specify voltage	Y55 • and identification code	✓	✓	✓	✓	✓	✓	✓	✓	✓	✓	✓	✓	✓	✓	✓
Other option																
Board for mains supply backup	E85	✓	✓	✓	✓	✓	✓	✓	✓	✓	✓	✓	✓	✓	✓	✓
RFI suppression filter																
RFI suppression filter, category C2 or C3 (class A)	L00	□	□	□	□	–	✓	✓	–	□	□	□	✓	✓	✓	–
Line Harmonics Filter																
Line Harmonics Filter for 50 Hz line frequency	L03	H92 ₆₎	H92 ₆₎	H93 ₆₎	✓ ⁵⁾	–	H93 ₆₎	✓ ⁵⁾	–	H92 ₆₎	H93 ₆₎	✓ ⁵⁾	H92 ₆₎	H93 ₆₎	✓ ⁵⁾	–
Line Harmonics Filter for 60 Hz line frequency	L04	H92 ₆₎	H92 ₆₎	H93 ₆₎	✓ ⁵⁾	–	H93 ₆₎	✓ ⁵⁾	–	H92 ₆₎	H93 ₆₎	✓ ⁵⁾	H92 ₆₎	H93 ₆₎	✓ ⁵⁾	–

For legends and footnotes, see Page 3/56.

SINAMICS G180

SINAMICS G180 cabinet units

SINAMICS G180 cabinet units
air-cooled and liquid-cooled

Options (continued)

Option text	Additional ordering data -Z with order code and, if necessary, with plain text specification	Air-cooled and liquid-cooled versions of SINAMICS G180 cabinet units															
		400 V					500 V					690 V					
		Pulse number															
Version – see selection and ordering data																	
6																	
12 6 12 6																	
12 18 24																	
A B C D E F G H I J K L M N O																	
Output filter																	
Strengthened dv/dt output filter for max. 250/300 m (type-dependent). Design for longer motor cables available on request	L10	☐	☐	☐	☐	☐	☐	☐	☐	☐	☑ ⁴⁾	☑ ⁴⁾	☑ ⁴⁾	☑ ⁴⁾	☑ ⁴⁾	☑ ⁴⁾	☑ ⁴⁾
Sine-wave filter integrated in control cabinet or additional cabinet, suitable for motor frequencies of ≤ 75 Hz, voltage drop of approximately 10 % of line voltage	L14	H91 ₆₎	H92 ₆₎	H92 ₆₎	H92 ₆₎	☑ ⁵⁾	H91 ₆₎	H92 ₆₎	☑ ⁵⁾	–	–	–	–	–	–	–	
Sine-wave filter integrated in control cabinet or additional cabinet, suitable for motor frequencies of ≤ 60 Hz, voltage drop of approximately 10 % of line voltage	L15	–	–	–	–	–	–	–	–	☑ ⁵⁾	☑ ⁵⁾	☑ ⁵⁾	☑ ⁵⁾	☑ ⁵⁾	☑ ⁵⁾	☑ ⁵⁾	
Standard accessories packages																	
Peripheral board 4 (G05) instead of peripheral board 2 (G03) (only in conjunction with package S01, S02, S03, S04, S08, S09, S11, S12)	G08	☑	☑	☑	☑	☑	☑	☑	☑	☑	☑	☑	☑	☑	☑	☑	
Accessories package S01 with main switch, line contactor, EMERGENCY OFF pushbutton and safety relay, board G03, local/remote switch	S01	☑	☑	☑	☑	☑	☑	☑	☑	☑	☑	☑	☑	☑	☑	☑	
Accessories package S02 with circuit breaker, line contactor, EMERGENCY OFF pushbutton and safety relay, board G03, local/remote switch	S02	☑	☑	☑	☑	☑	☑	☑	☑	☑	☑	☑	☑	☑	☑	☑	
Accessories package with main switch, line contactor, board G03, local/remote switch	S03	☑	☑	☑	☑	☑	☑	☑	☑	☑	☑	☑	☑	☑	☑	☑	
Accessories package with circuit breaker, line contactor, board G03, local/remote switch	S04	☑	☑	☑	☑	☑	☑	☑	☑	☑	☑	☑	☑	☑	☑	☑	
Accessories package with main switch, line contactor, Calomat, RCU box connection	S06	☑	☑	☑	☑	☑	☑	☑	☑	☑	☑	☑	☑	☑	☑	☑	
Bypass for smooth line synchronization (soft start function) incl. line-side main switch and contactors at the converter output and in bypass	S08	H92 ₆₎	H92 ₆₎	H92 ₆₎	H92 ₆₎	☑ ⁵⁾	H92 ₆₎	H92 ₆₎	☑ ⁵⁾	H92 ₆₎	H92 ₆₎	H92 ₆₎	☑ ⁵⁾	☑ ⁵⁾	☑ ⁵⁾	☑ ⁵⁾	
Bypass for smooth line synchronization (soft start function) incl. line-side circuit breaker and contactors at the converter output and in bypass	S09	H92 ₆₎	H92 ₆₎	H92 ₆₎	H92 ₆₎	☑ ⁵⁾	H92 ₆₎	H92 ₆₎	☑ ⁵⁾	H92 ₆₎	H92 ₆₎	H92 ₆₎	☑ ⁵⁾	☑ ⁵⁾	☑ ⁵⁾	☑ ⁵⁾	
Accessories package S11 with line-side main switch, board G03, local/remote switch	S11	☑	☑	☑	☑	☑	☑	☑	☑	☑	☑	☑	☑	☑	☑	☑	
Accessories package S12 with line-side circuit breaker, board G03, local/remote switch	S12	☑	☑	☑	☑	☑	☑	☑	☑	☑	☑	☑	☑	☑	☑	☑	
Bypass with line-side main switch, contactors at converter output and in bypass, switchover between manual and automatic, local/remote switch	S21	H91 ₆₎	H91 ₆₎	H91 ₆₎	H91 ₆₎	☑ ⁵⁾	H91 ₆₎	H91 ₆₎	☑ ⁵⁾	H91 ₆₎	H91 ₆₎	H91 ₆₎	☑ ⁵⁾	☑ ⁵⁾	☑ ⁵⁾	☑ ⁵⁾	
Bypass with line-side circuit breaker, contactors at converter output and in bypass, switchover between manual and automatic, local/remote switch	S22	H91 ₆₎	H91 ₆₎	H91 ₆₎	H91 ₆₎	☑ ⁵⁾	H91 ₆₎	H91 ₆₎	☑ ⁵⁾	H91 ₆₎	H91 ₆₎	H91 ₆₎	☑ ⁵⁾	☑ ⁵⁾	☑ ⁵⁾	☑ ⁵⁾	
Bypass with line-side main switch, contactors at converter output and in bypass, EMERGENCY OFF safety relay, switchover between manual and automatic, local/remote switch	S23	H91 ₆₎	H91 ₆₎	H91 ₆₎	H91 ₆₎	☑ ⁵⁾	H91 ₆₎	H91 ₆₎	☑ ⁵⁾	H91 ₆₎	H91 ₆₎	H91 ₆₎	☑ ⁵⁾	☑ ⁵⁾	☑ ⁵⁾	☑ ⁵⁾	
Bypass with line-side circuit breaker, contactors at converter output and in bypass, EMERGENCY OFF safety relay, switchover between manual and automatic, local/remote switch	S24	H91 ₆₎	H91 ₆₎	H91 ₆₎	H91 ₆₎	☑ ⁵⁾	H91 ₆₎	H91 ₆₎	☑ ⁵⁾	H91 ₆₎	H91 ₆₎	H91 ₆₎	☑ ⁵⁾	☑ ⁵⁾	☑ ⁵⁾	☑ ⁵⁾	

For legends and footnotes, see Page 3/56.

SINAMICS G180

SINAMICS G180 cabinet units

SINAMICS G180 cabinet units air-cooled and liquid-cooled

Options (continued)

Option text	Additional ordering data -Z with order code and, if necessary, with plain text specification	Air-cooled and liquid-cooled versions of SINAMICS G180 cabinet units																	
		400 V					500 V					690 V							
		Pulse number																	
		6				12	6			12	6					12	18	24	
		Version – see selection and ordering data																	
		A	B	C	D	E	F	G	H	I	J	K	L	M	N	O			
Standard accessories packages (continued)																			
NAMUR accessories package with Test/Normal operation switch, option G05, terminal strip compliant with NAMUR NE37 (without main switch)	S31	✓	✓	✓	✓	✓	✓	✓	✓	✓	✓	✓	✓	✓	✓	✓	✓	✓	
NAMUR accessories package with Test/Normal operation switch, main switch, line contactor, option G05, terminal strip compliant with NAMUR NE37	S32	✓	✓	✓	✓	✓	✓	✓	✓	✓	✓	✓	✓	✓	✓	✓	✓	✓	
Braking chopper																			
Braking chopper integrated into converter (braking resistor is not included and must be ordered separately)	L72	✓	✓	✓	✓	✓	✓	✓	✓	✓	✓	✓	✓	✓	✓	✓	✓	✓	
Insulation monitoring																			
Integrated insulation monitoring system for operation on secondary side of unit transformer in an IT system	L87	-	-	-	-	□	-	-	□	-	-	-	-	-	-	-	-	□	
CALOMAT CK145																			
CALOMAT CK145 without storage for motor temperature prewarning	L80	✓	✓	✓	✓	✓	✓	✓	✓	✓	✓	✓	✓	✓	✓	✓	✓	✓	
CALOMAT CK145 with storage for motor temperature trip	L81	✓	✓	✓	✓	✓	✓	✓	✓	✓	✓	✓	✓	✓	✓	✓	✓	✓	
CALOMAT CK145 without storage for transformer temperature prewarning	L82	✓	✓	✓	✓	✓	✓	✓	✓	✓	✓	✓	✓	✓	✓	✓	✓	✓	
CALOMAT CK145 with storage for transformer temperature trip	L83	✓	✓	✓	✓	✓	✓	✓	✓	✓	✓	✓	✓	✓	✓	✓	✓	✓	
CALOMAT CK145 for other PTC thermistor monitoring functions	Y80 • and identification code	✓	✓	✓	✓	✓	✓	✓	✓	✓	✓	✓	✓	✓	✓	✓	✓	✓	
Pt100 evaluation unit																			
Pt100 evaluation unit for motor winding temperature, integrated in control cabinet for monitoring of 3 × Pt100 or 3 × KTY83/84 sensors	L90	✓	✓	✓	✓	✓	✓	✓	✓	✓	✓	✓	✓	✓	✓	✓	✓	✓	
Pt100 evaluation unit for motor bearing temperature, integrated in control cabinet for monitoring of 2 × Pt100 or 2 × KTY83/84 sensors	L91	✓	✓	✓	✓	✓	✓	✓	✓	✓	✓	✓	✓	✓	✓	✓	✓	✓	
Pt100 evaluation unit for motor winding temperature, integrated in cabinet for monitoring 3 × Pt100 sensors; plus an analog output 0 to 10 V or 0(4) to 20 mA connected to terminals for the hottest winding temperature	L92	✓	✓	✓	✓	✓	✓	✓	✓	✓	✓	✓	✓	✓	✓	✓	✓	✓	
Pt100 evaluation unit for motor bearing temperature, integrated in cabinet for monitoring 2 × Pt100 sensors or 2 × KTY83/84 sensors; plus two analog outputs 0 to 10 V or 0(4) to 20 mA connected to terminals for bearing temperature	L93	✓	✓	✓	✓	✓	✓	✓	✓	✓	✓	✓	✓	✓	✓	✓	✓	✓	
Pt100 evaluation unit for motor winding and bearing temperatures, integrated in cabinet for monitoring 6 × Pt100 sensors; plus two analog outputs 0 to 10 V or 0(4) to 20 mA connected to terminals for the hottest winding and bearing temperatures	L94	✓	✓	✓	✓	✓	✓	✓	✓	✓	✓	✓	✓	✓	✓	✓	✓	✓	
Pt100 evaluation unit for other temperature monitoring functions, integrated in cabinet for monitoring of 3 × Pt100 or 3 × KTY83/84 sensors	Y90 • and identification code	✓	✓	✓	✓	✓	✓	✓	✓	✓	✓	✓	✓	✓	✓	✓	✓	✓	
Pt100 evaluation unit for other temperature monitoring functions, integrated in cabinet for monitoring 6 × Pt100 sensors; plus two analog outputs 0 to 10 V or 0(4) to 20 mA connected to terminals	Y94 • and identification code	✓	✓	✓	✓	✓	✓	✓	✓	✓	✓	✓	✓	✓	✓	✓	✓	✓	

For legends and footnotes, see Page 3/56.

SINAMICS G180

SINAMICS G180 cabinet units

SINAMICS G180 cabinet units
air-cooled and liquid-cooled

Options (continued)

Option text	Additional ordering data -Z with order code and, if necessary, with plain text specification	Air-cooled and liquid-cooled versions of SINAMICS G180 cabinet units														
		400 V					500 V					690 V				
		Pulse number 6					12					6				
		A	B	C	D	E	F	G	H	I	J	K	L	M	N	O
Degrees of protection																
Increased degree of protection IP41 for air-cooled cabinet units and systems	M41	✓	✓	✓	✓	✓	✓	✓	✓	✓	✓	✓	✓	✓	✓	✓
Increased degree of protection IP43 for air-cooled cabinet units and systems	M43	✓	✓	✓	✓	✓	✓	✓	✓	✓	✓	✓	✓	✓	✓	✓
Increased degree of protection IP54 for air-cooled cabinet units and systems; not suitable for outdoor applications	M54	✓	✓	-	-	-	✓	-	-	✓	✓	-	-	-	-	-
Increased degree of protection IP55 for liquid-cooled cabinet units (no display in cabinet door)	M55	✓	✓	✓	✓	✓	✓	✓	✓	✓	✓	✓	✓	✓	✓	✓
Air flange for connection to customer's exhaust air systems (air outlet IP00)	M63	✓	✓	✓	✓	✓	✓	✓	✓	✓	✓	✓	✓	✓	✓	✓
Cabinet options																
Control cabinet base, welded and suitable for use with transport rollers, in RAL 7035, h = 200 mm	M05	✓	✓	✓	✓	✓	✓	✓	✓	✓	✓	✓	✓	✓	✓	✓
Control cabinet base, standard version in RAL 7022/9005, h = 100 mm	M06	✓	✓	✓	✓	✓	✓	✓	✓	✓	✓	✓	✓	✓	✓	✓
Control cabinet base, standard version in RAL 7022/9005, h = 200 mm	M07	✓	✓	✓	✓	✓	✓	✓	✓	✓	✓	✓	✓	✓	✓	✓
Cable entry from the top: Power cable	M13	✓ ⁽⁵⁾	✓ ⁽⁵⁾	✓ ⁽⁵⁾	✓ ⁽⁵⁾	✓ ⁽⁵⁾	✓ ⁽⁵⁾	✓ ⁽⁵⁾	✓ ⁽⁵⁾	✓ ⁽⁵⁾	✓ ⁽⁵⁾	✓ ⁽⁵⁾	✓ ⁽⁵⁾	✓ ⁽⁵⁾	✓ ⁽⁵⁾	✓ ⁽⁵⁾
Door opening angle 180°	M17	✓	✓	✓	✓	✓	✓	✓	✓	✓	✓	✓	✓	✓	✓	✓
Window in door for viewing internal display	M19	✓	✓	✓	✓	✓	✓	✓	✓	✓	✓	✓	✓	✓	✓	✓
Partitions between compact units for cabinet systems	M24	✓	✓	✓	✓	✓	✓	✓	✓	✓	✓	✓	✓	✓	✓	✓
Door hinge on left	M28	✓	✓	✓	✓	✓	✓	✓	✓	✓	✓	✓	✓	✓	✓	✓
Cable entry from the top: Control cables	M34	✓ ⁽⁵⁾	✓ ⁽⁵⁾	✓ ⁽⁵⁾	✓ ⁽⁵⁾	✓ ⁽⁵⁾	✓ ⁽⁵⁾	✓ ⁽⁵⁾	✓ ⁽⁵⁾	✓ ⁽⁵⁾	✓ ⁽⁵⁾	✓ ⁽⁵⁾	✓ ⁽⁵⁾	✓ ⁽⁵⁾	✓ ⁽⁵⁾	✓ ⁽⁵⁾
Comfort-grip handle with double-bit key lock	M38	✓	✓	✓	✓	✓	✓	✓	✓	✓	✓	✓	✓	✓	✓	✓
Comfort-grip handle with integrated pushbutton	M39	✓	✓	✓	✓	✓	✓	✓	✓	✓	✓	✓	✓	✓	✓	✓
Comfort-grip handle with cylinder lock	M40	✓	✓	✓	✓	✓	✓	✓	✓	✓	✓	✓	✓	✓	✓	✓
Air supply via cable floor. No filter mats required in door	M59	✓	✓	✓	✓	✓	✓	✓	✓	✓	✓	✓	✓	✓	✓	✓
Cable entry from the top: Motor cables	M78	✓ ⁽⁵⁾	✓ ⁽⁵⁾	✓ ⁽⁵⁾	✓ ⁽⁵⁾	✓ ⁽⁵⁾	✓ ⁽⁵⁾	✓ ⁽⁵⁾	✓ ⁽⁵⁾	✓ ⁽⁵⁾	✓ ⁽⁵⁾	✓ ⁽⁵⁾	✓ ⁽⁵⁾	✓ ⁽⁵⁾	✓ ⁽⁵⁾	✓ ⁽⁵⁾
Special control cabinet paint color: Please specify RAL	Y09 • and identification code	✓	✓	✓	✓	✓	✓	✓	✓	✓	✓	✓	✓	✓	✓	✓
Window in door for viewing internal components	Y19 • and identification code	✓	✓	✓	✓	✓	✓	✓	✓	✓	✓	✓	✓	✓	✓	✓
Control elements and display instruments in control cabinet door																
SENTRON PAC3200 power monitoring device (without current transformer)	G10	✓	✓	✓	✓	✓	✓	✓	✓	✓	✓	✓	✓	✓	✓	✓
SENTRON PAC3200 power monitoring device (with current transformer)	G11	✓	✓	✓	✓	✓	✓	✓	✓	✓	✓	✓	✓	✓	✓	✓
External 4-line operator panel, supplied separately packed	K14	✓	✓	✓	✓	✓	✓	✓	✓	✓	✓	✓	✓	✓	✓	✓
External 4-line operator panel integrated in control cabinet door	K15	□	□	□	□	□	□	□	□	□	□	□	□	□	□	□
Selector switch in form of key-operated switch	K37	✓	✓	✓	✓	✓	✓	✓	✓	✓	✓	✓	✓	✓	✓	✓
Accessories																
Grounding socket outlet 230 V, 50 Hz, 10 A, in control cabinet with 30 mA ground-fault circuit interrupter, external incoming supply	L48	✓	✓	✓	✓	✓	✓	✓	✓	✓	✓	✓	✓	✓	✓	✓
Socket outlet 230 V, 50 Hz, 1 A, in control cabinet with 30 mA ground-fault circuit interrupter, supplied internally	L49	✓	✓	✓	✓	✓	✓	✓	✓	✓	✓	✓	✓	✓	✓	✓
Magnetically attached cabinet light and door contact switch	L50	✓	✓	✓	✓	✓	✓	✓	✓	✓	✓	✓	✓	✓	✓	✓

For legends and footnotes, see Page 3/56.

SINAMICS G180

SINAMICS G180 cabinet units

SINAMICS G180 cabinet units air-cooled and liquid-cooled

Options (continued)

Option text	Additional ordering data -Z with order code and, if necessary, with plain text specification	Air-cooled and liquid-cooled versions of SINAMICS G180 cabinet units														
		400 V					500 V					690 V				
		Pulse number														
		6		12	6		12	6		12	6		12	18	24	
		Version – see selection and ordering data														
		A	B	C	D	E	F	G	H	I	J	K	L	M	N	O
Accessories (continued)																
Cabinet heater to protect against condensation and/or for operation with supply air temperature of -5 °C or below	L55	✓	✓	✓	✓	✓	✓	✓	✓	✓	✓	✓	✓	✓	✓	✓
Controlled outgoing feeder for motor heater, 230 V 1 AC, max. 4 kW	N35	✓	✓	✓	✓	✓	✓	✓	✓	✓	✓	✓	✓	✓	✓	✓
Controlled outgoing feeder for external motor fan, external fan voltage for 3 AC. Converter line voltage, max. 4 kW	N36	✓	✓	✓	✓	✓	✓	✓	✓	✓	✓	✓	✓	✓	✓	✓
Undervoltage release for main switch or circuit breaker; specify coil voltage	Y11 • and identification code	✓	✓	✓	✓	✓	✓	✓	✓	✓	✓	✓	✓	✓	✓	✓
Controlled outgoing feeder for auxiliary drive up to max. 4 kW; please specify type of drive, voltage, number of phases	Y98 • and identification code	✓	✓	✓	✓	✓	✓	✓	✓	✓	✓	✓	✓	✓	✓	✓
Marking of cable cores and items of equipment																
Dual marking of items of equipment	M96	✓	✓	✓	✓	✓	✓	✓	✓	✓	✓	✓	✓	✓	✓	✓
Cable marking, C-type	M93	✓	✓	✓	✓	✓	✓	✓	✓	✓	✓	✓	✓	✓	✓	✓
Cable marking (shrink-on sleeve)	M94	✓	✓	✓	✓	✓	✓	✓	✓	✓	✓	✓	✓	✓	✓	✓
Wiring options																
Cross-section of cables installed inside cabinet 1.5 mm ²	M20	✓	✓	✓	✓	✓	✓	✓	✓	✓	✓	✓	✓	✓	✓	✓
Use of halogen-free cables inside cabinet	N50	✓	✓	✓	✓	✓	✓	✓	✓	✓	✓	✓	✓	✓	✓	✓
Peripheral boards																
Peripheral board 1	G02	✓	✓	✓	✓	✓	✓	✓	✓	✓	✓	✓	✓	✓	✓	✓
Peripheral board 2	G03	✓	✓	✓	✓	✓	✓	✓	✓	✓	✓	✓	✓	✓	✓	✓
Peripheral board 3	G04	✓	✓	✓	✓	✓	✓	✓	✓	✓	✓	✓	✓	✓	✓	✓
Peripheral board 4	G05	✓	✓	✓	✓	✓	✓	✓	✓	✓	✓	✓	✓	✓	✓	✓
Additional boards for bus connection																
Board for PROFIBUS DP-V1	G01	✓	✓	✓	✓	✓	✓	✓	✓	✓	✓	✓	✓	✓	✓	✓
PROFIBUS expansion module for option G10 or G11 (SENTRON PAC3200 power monitoring device)	G12	✓	✓	✓	✓	✓	✓	✓	✓	✓	✓	✓	✓	✓	✓	✓
Board for CANopen	G20	✓	✓	✓	✓	✓	✓	✓	✓	✓	✓	✓	✓	✓	✓	✓
Board for Modbus RTU	G22	✓	✓	✓	✓	✓	✓	✓	✓	✓	✓	✓	✓	✓	✓	✓
Board for Modbus TCP	G27	✓	✓	✓	✓	✓	✓	✓	✓	✓	✓	✓	✓	✓	✓	✓
Accessories for IMS																
USB PROFIBUS interface (supplied separately packed)	G13	✓	✓	✓	✓	✓	✓	✓	✓	✓	✓	✓	✓	✓	✓	✓
Ethernet-PROFIBUS gateway	G14	✓	✓	✓	✓	✓	✓	✓	✓	✓	✓	✓	✓	✓	✓	✓
Ethernet-to-RS232/485/422 converter (supplied separately packed)	G15	✓	✓	✓	✓	✓	✓	✓	✓	✓	✓	✓	✓	✓	✓	✓
USB cable A/B (supplied separately packed)	G16	✓	✓	✓	✓	✓	✓	✓	✓	✓	✓	✓	✓	✓	✓	✓
USB connector on front of control cabinet door	G18	✓	✓	✓	✓	✓	✓	✓	✓	✓	✓	✓	✓	✓	✓	✓
Extension of the liability for defects																
Extension of the liability for defects by 12 months as of commissioning date or by 24 months as of delivery date	Q80	✓	✓	✓	✓	✓	✓	✓	✓	✓	✓	✓	✓	✓	✓	✓
Extension of the liability for defects by 18 months as of commissioning date or by 30 months as of delivery date	Q81	✓	✓	✓	✓	✓	✓	✓	✓	✓	✓	✓	✓	✓	✓	✓
Extension of the liability for defects by 24 months as of commissioning date or by 36 months as of delivery date	Q82	✓	✓	✓	✓	✓	✓	✓	✓	✓	✓	✓	✓	✓	✓	✓
Extension of the liability for defects by 30 months as of commissioning date or by 42 months as of delivery date	Q83	✓	✓	✓	✓	✓	✓	✓	✓	✓	✓	✓	✓	✓	✓	✓

For legends and footnotes, see Page 3/56.

SINAMICS G180

SINAMICS G180 cabinet units

SINAMICS G180 cabinet units
air-cooled and liquid-cooled

Options (continued)

Option text	Additional ordering data -Z with order code and, if necessary, with plain text specification	Air-cooled and liquid-cooled versions of SINAMICS G180 cabinet units															
		400 V					500 V					690 V					
		Pulse number					Pulse number					Pulse number					
		6				12	6			12	6				12	18	24
		Version – see selection and ordering data															
		A	B	C	D	E	F	G	H	I	J	K	L	M	N	O	
Extension of the liability for defects (continued)																	
Extension of the liability for defects by 36 months as of commissioning date or by 48 months as of delivery date	Q84	✓	✓	✓	✓	✓	✓	✓	✓	✓	✓	✓	✓	✓	✓	✓	✓
Extension of the liability for defects by 48 months as of commissioning date or by 60 months as of delivery date	Q85	✓	✓	✓	✓	✓	✓	✓	✓	✓	✓	✓	✓	✓	✓	✓	✓
Label for plant identification																	
Cabinet designation TAG/ITEM number according to ordering data	T01	✓	✓	✓	✓	✓	✓	✓	✓	✓	✓	✓	✓	✓	✓	✓	✓
Customized labels	Y33 • and identification code	✓	✓	✓	✓	✓	✓	✓	✓	✓	✓	✓	✓	✓	✓	✓	✓
Ambient temperature for air-cooled converters																	
45 °C ambient temperature (with corresponding derating)	V61	✓	✓	✓	✓	✓	✓	✓	✓	✓	✓	✓	✓	✓	✓	✓	✓
50 °C ambient temperature (with corresponding derating)	V62	✓	✓	✓	✓	✓	✓	✓	✓	✓	✓	✓	✓	✓	✓	✓	✓
Water inlet temperature for liquid-cooled converters																	
30 °C water inlet temperature (with corresponding derating)	V66	✓	✓	✓	✓	✓	✓	✓	✓	✓	✓	✓	✓	✓	✓	✓	✓
35 °C water inlet temperature (with corresponding derating)	V67	✓	✓	✓	✓	✓	✓	✓	✓	✓	✓	✓	✓	✓	✓	✓	✓
40 °C water inlet temperature (with corresponding derating)	V68	✓	✓	✓	✓	✓	✓	✓	✓	✓	✓	✓	✓	✓	✓	✓	✓
Installation altitude																	
Installation altitude max. 1500 m above sea level (with corresponding derating)	V86	✓	✓	✓	✓	✓	✓	✓	✓	✓	✓	✓	✓	✓	✓	✓	✓
Installation altitude max. 2000 m above sea level (with corresponding derating)	V87	✓	✓	✓	✓	✓	✓	✓	✓	✓	✓	✓	✓	✓	✓	✓	✓
Installation altitude max. 2500 m above sea level (with corresponding derating)	V88	✓	✓	✓	✓	✓	✓	✓	✓	✓	✓	✓	✓	✓	✓	✓	✓
Installation altitude max. 3000 m above sea level (with corresponding derating)	V89	✓	✓	✓	✓	✓	✓	✓	✓	✓	✓	✓	✓	✓	✓	✓	✓
Acceptance tests for converters																	
Routine test under no-load conditions with customer present	F71	✓	✓	✓	✓	✓	✓	✓	✓	✓	✓	✓	✓	✓	✓	✓	✓
Routine test with 1PS or 1MD motor (ordered with converter in package), under no-load conditions (without customer present)	F72	✓	✓	✓	✓	✓	✓	✓	✓	✓	✓	✓	✓	✓	✓	✓	✓
Routine test with 1PS or 1MD motor (ordered with converter in package), under no-load conditions with customer present	F73	✓	✓	✓	✓	✓	✓	✓	✓	✓	✓	✓	✓	✓	✓	✓	✓
Visual inspection and function test under rated load using test bay motor (without customer present)	F80	✓	✓	✓	✓	✓	✓	✓	✓	✓	✓	✓	✓	✓	✓	✓	✓
Visual inspection and function test under rated load using test bay motor with customer present	F81	✓	✓	✓	✓	✓	✓	✓	✓	✓	✓	✓	✓	✓	✓	✓	✓
Visual inspection and function test under rated load with 1PS or 1MD motor (ordered with converter in package) (without customer present)	F82	✓	✓	✓	✓	✓	✓	✓	✓	✓	✓	✓	✓	✓	✓	✓	✓
Visual inspection and function test under rated load with 1PS or 1MD motor (ordered with converter in package) with customer present	F83	✓	✓	✓	✓	✓	✓	✓	✓	✓	✓	✓	✓	✓	✓	✓	✓
Advanced visual inspection and function test under rated load with 1PS or 1MD motor (ordered with converter in package) (without customer present)	F84	✓	✓	✓	✓	✓	✓	✓	✓	✓	✓	✓	✓	✓	✓	✓	✓

For legends and footnotes, see Page 3/56.

SINAMICS G180

SINAMICS G180 cabinet units

SINAMICS G180 cabinet units air-cooled and liquid-cooled

Options (continued)

Option text	Additional ordering data -Z with order code and, if necessary, with plain text specification	Air-cooled and liquid-cooled versions of SINAMICS G180 cabinet units														
		400 V					500 V					690 V				
		Pulse number														
		6			12		6			12		6			12	
		Version – see selection and ordering data														
		A	B	C	D	E	F	G	H	I	J	K	L	M	N	O
Acceptance tests for converters (continued)																
Advanced visual inspection and function test under rated load with 1PS or 1MD motor (ordered with converter in package) with customer present	F85	✓	✓	✓	✓	✓	✓	✓	✓	✓	✓	✓	✓	✓	✓	✓
Supplementary documentation																
Test sequence schedule	B48	✓	✓	✓	✓	✓	✓	✓	✓	✓	✓	✓	✓	✓	✓	✓
Spare parts price list	B38	✓	✓	✓	✓	✓	✓	✓	✓	✓	✓	✓	✓	✓	✓	✓
Production flowchart: Generated once	B43	✓	✓	✓	✓	✓	✓	✓	✓	✓	✓	✓	✓	✓	✓	✓
Production flowchart: Generated once per month	B45	✓	✓	✓	✓	✓	✓	✓	✓	✓	✓	✓	✓	✓	✓	✓
Converter display language																
Display language Norwegian/English	T23	✓	✓	✓	✓	✓	✓	✓	✓	✓	✓	✓	✓	✓	✓	✓
Display language Swedish/English	T24	✓	✓	✓	✓	✓	✓	✓	✓	✓	✓	✓	✓	✓	✓	✓
Display language Czech/English	T25	✓	✓	✓	✓	✓	✓	✓	✓	✓	✓	✓	✓	✓	✓	✓
Display language Hungarian/English	T26	✓	✓	✓	✓	✓	✓	✓	✓	✓	✓	✓	✓	✓	✓	✓
Display language French/English	T58	✓	✓	✓	✓	✓	✓	✓	✓	✓	✓	✓	✓	✓	✓	✓
Display language Spanish/English	T60	✓	✓	✓	✓	✓	✓	✓	✓	✓	✓	✓	✓	✓	✓	✓
Display language German/English	T74	✓	✓	✓	✓	✓	✓	✓	✓	✓	✓	✓	✓	✓	✓	✓
Display language English/German	T76	✓	✓	✓	✓	✓	✓	✓	✓	✓	✓	✓	✓	✓	✓	✓
Display language Portuguese/English	T82	✓	✓	✓	✓	✓	✓	✓	✓	✓	✓	✓	✓	✓	✓	✓
Display language Russian/English	T85	✓	✓	✓	✓	✓	✓	✓	✓	✓	✓	✓	✓	✓	✓	✓
Display language Polish/English	T86	✓	✓	✓	✓	✓	✓	✓	✓	✓	✓	✓	✓	✓	✓	✓
Converter documentation																
Manual and set of diagrams in PDF format per e-mail, German/English	D01	□	□	□	□	□	□	□	□	□	□	□	□	□	□	□
Manual in PDF format, set of diagrams in DXF format per e-mail, German/English	D02	✓	✓	✓	✓	✓	✓	✓	✓	✓	✓	✓	✓	✓	✓	✓
Manual and set of diagrams, single hardcopy, German/English	D04	✓	✓	✓	✓	✓	✓	✓	✓	✓	✓	✓	✓	✓	✓	✓
Manual and set of diagrams in PDF format on CD, German/English	D05	✓	✓	✓	✓	✓	✓	✓	✓	✓	✓	✓	✓	✓	✓	✓
Manual in PDF format, set of diagrams in DWG format on CD, German/English	D06	✓	✓	✓	✓	✓	✓	✓	✓	✓	✓	✓	✓	✓	✓	✓
Language of assembly and operating instructions																
Different language for assembly and operating instructions	Y13 • and identification code	✓	✓	✓	✓	✓	✓	✓	✓	✓	✓	✓	✓	✓	✓	✓
Certifications																
Gost R certificate	U04	✓	✓	✓	✓	✓	✓	✓	✓	✓	✓	✓	✓	✓	✓	✓
Engineering (for description, see Page 4/34)																
Mechanical system		✓	✓	✓	✓	✓	✓	✓	✓	✓	✓	✓	✓	✓	✓	✓
Parameterization		✓	✓	✓	✓	✓	✓	✓	✓	✓	✓	✓	✓	✓	✓	✓
Electrical (power output, control)		✓	✓	✓	✓	✓	✓	✓	✓	✓	✓	✓	✓	✓	✓	✓
Extended overvoltage range		– ⁷⁾	– ⁷⁾	– ⁷⁾	– ⁷⁾	– ⁷⁾	– ⁸⁾	– ⁸⁾	– ⁸⁾	✓	✓	✓	✓	✓	✓	✓
Test bay converter		✓	✓	✓	✓	✓	✓	✓	✓	✓	✓	✓	✓	✓	✓	✓
Special tests		✓	✓	✓	✓	✓	✓	✓	✓	✓	✓	✓	✓	✓	✓	✓
Special documentation		✓	✓	✓	✓	✓	✓	✓	✓	✓	✓	✓	✓	✓	✓	✓
Special version		✓	✓	✓	✓	✓	✓	✓	✓	✓	✓	✓	✓	✓	✓	✓

✓ Available

□ Standard version

– Not possible

- This order code only determines the price of the version – additional plain text is required.

1) Voltage between 230 and 415 V.

2) Voltage between 230 and 500 V.

3) Voltage between 400 and 690 V.

4) Please refer to technical data for cabinet dimensions.

5) Please ask your Siemens contact person for the exact cabinet dimensions.

6) Additional option included in the original option.

7) 500 V cabinet units + the next-higher rating must be selected for the "Extended overvoltage range" function.

8) 690 V cabinet units + the next-higher rating must be selected for the "Extended overvoltage range" function.

SINAMICS G180

SINAMICS G180 cabinet units

SINAMICS G180 cabinet units
air-cooled

Design

- Control cabinet manufactured by Rittal TS8
- IP21 degree of protection, higher degree of protection available as option
- Cable clamping bar and shielding bus integrated
- Convenient terminal compartment for EMC-compliant cable connections to NAMUR NE 37
- Complete touch protection in accordance with Employers' Liability Association regulations (BGV A3)
- Cable entry from below

Selection and ordering data

400 V, 6-pulse

SINAMICS G180 cabinet unit (230 to 415 V 3 AC TN/TT system, 50 to 60 Hz)

Converter type	Connected load kVA	Output		Type rating ²⁾ kW	SINAMICS G180 cabinet units, air-cooled Article No.	Version (for option selection)
		Continuous current A	Short-time current ¹⁾ A			
2T3A-87401-200	249	380	470	200	6SE0180-1BA33-7 ■ A7	A
2T3A-87401-250	300	460	560	250	6SE0180-1BA34-6 ■ A7	A
2T3A-87401-315	403	630	700	315	6SE0180-1BA36-3 ■ A7	B
2T3A-87401-400	476	740	900	400	6SE0180-1BA37-3 ■ A7	C
2T3A-87401-500	603	910	1110	500	6SE0180-1BA38-8 ■ A7	C
2T3A-87401-560	676	1020	1230	560	6SE0180-1BA41-0 ■ A7	D
2T3A-87401-630	761	1140	1370	630	6SE0180-1BA41-1 ■ A7	D

See article number code on Page 3/48.

400 V, 12-pulse incl. shift transformer

SINAMICS G180 cabinet unit (230 to 415 V 3 AC TN/TT system, 50 to 60 Hz)

Converter type	Connected load kVA	Output		Type rating ²⁾ kW	SINAMICS G180 cabinet units, air-cooled Article No.	Version (for option selection)
		Continuous current A	Short-time current ¹⁾ A			
2T3F-87401-200	249	380	470	200	6SE0180-2BA33-7 ■ A7	E
2T3F-87401-250	301	460	560	250	6SE0180-2BA34-6 ■ A7	E
2T3F-87401-315	405	630	700	315	6SE0180-2BA36-3 ■ A7	E
2T3F-87401-400	477	740	900	400	6SE0180-2BA37-3 ■ A7	E
2T3F-87401-500	604	910	1110	500	6SE0180-2BA38-8 ■ A7	E
2T3F-87401-560	676	1020	1230	560	6SE0180-2BA41-0 ■ A7	E
2T3F-87401-630	762	1140	1370	630	6SE0180-2BA41-1 ■ A7	E

See article number code on Page 3/48.

Notice:

The 400 V, 12-pulse, air-cooled version of the SINAMICS G180 cabinet unit is operated with a shift transformer. In this case, the first system is supplied directly from the mains via the line reactor and the second system via a shift transformer. This shift transformer is supplied as a separately packed item (degree of protection IP00) with the converter. At the customer's request, this transformer can also be installed in a separate control cabinet or in the converter cabinet itself if required.

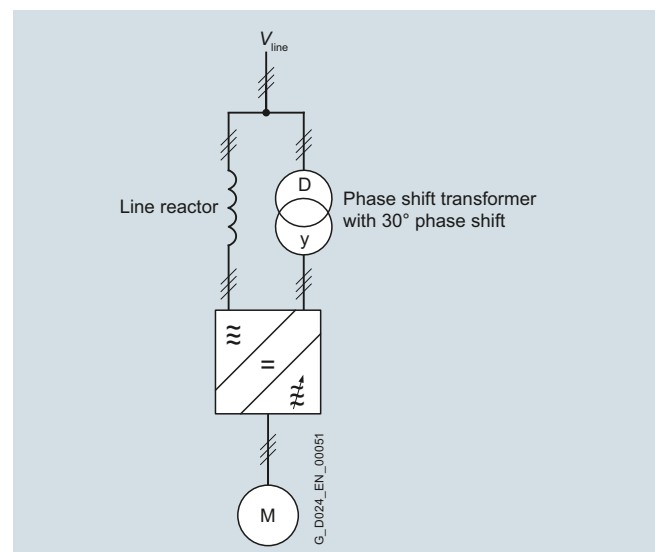

¹⁾ Short-time current for 60 s every 10 minutes.

²⁾ Rated power of a typical 2- to 6-pole standard motor.

SINAMICS G180

SINAMICS G180 cabinet units

SINAMICS G180 cabinet units air-cooled

Selection and ordering data (continued)

500 V, 6-pulse

SINAMICS G180 cabinet unit (230 to 500 V 3 AC TN/TT system, 50 to 60 Hz)

Converter type	Connected load kVA	Output		Type rating ²⁾ kW	SINAMICS G180 cabinet units, air-cooled Article No.	Version (for option selection)
		Continuous current A	Short-time current ¹⁾ A			
2T3A-87501-250	303	370	450	250	6SE0180-1BC33-7 ■ A7	F
2T3A-87501-315	378	460	560	315	6SE0180-1BC34-6 ■ A7	F
2T3A-87501-400	514	640	700	400	6SE0180-1BC36-3 ■ A7	G
2T3A-87501-500	606	730	900	500	6SE0180-1BC37-3 ■ A7	G
2T3A-87501-560	678	820	980	560	6SE0180-1BC38-2 ■ A7	G
2T3A-87501-630	767	920	1100	630	6SE0180-1BC38-8 ■ A7	G
2T3A-87501-710	848	1030	1230	710	6SE0180-1BC41-0 ■ A7	G
2T3A-87501-800	944	1150	1380	800	6SE0180-1BC41-1 ■ A7	G

See article number code on Page 3/48.

SINAMICS G180 cabinet unit (230 to 500 V 3 AC IT system, 50 to 60 Hz)

Converter type	Connected load kVA	Output		Type rating ²⁾ kW	SINAMICS G180 cabinet units, air-cooled Article No.	Version (for option selection)
		Continuous current A	Short-time current ¹⁾ A			
2T3A-87501-250	303	370	450	250	6SE0180-1BD33-7 ■ A7	F
2T3A-87501-315	378	460	560	315	6SE0180-1BD34-6 ■ A7	F
2T3A-87501-400	514	640	700	400	6SE0180-1BD36-3 ■ A7	G
2T3A-87501-500	606	730	900	500	6SE0180-1BD37-3 ■ A7	G
2T3A-87501-560	678	820	980	560	6SE0180-1BD38-2 ■ A7	G
2T3A-87501-630	767	920	1100	630	6SE0180-1BD38-8 ■ A7	G
2T3A-87501-710	848	1030	1230	710	6SE0180-1BD41-0 ■ A7	G
2T3A-87501-800	944	1150	1380	800	6SE0180-1BD41-1 ■ A7	G

See article number code on Page 3/48.

500 V, 12-pulse

SINAMICS G180 cabinet unit (3 × 230 to 500 V 3 AC IT system, 50 to 60 Hz)

Converter type	Connected load kVA	Output		Type rating ²⁾ kW	SINAMICS G180 cabinet units, air-cooled Article No.	Version (for option selection)
		Continuous current A	Short-time current ¹⁾ A			
2T3F-87501-250	303	370	450	250	6SE0180-2BD33-7 ■ A7	H
2T3F-87501-315	378	460	560	315	6SE0180-2BD34-6 ■ A7	H
2T3F-87501-400	516	640	700	400	6SE0180-2BD36-3 ■ A7	H
2T3F-87501-500	606	730	900	500	6SE0180-2BD37-3 ■ A7	H
2T3F-87501-560	677	820	980	560	6SE0180-2BD38-2 ■ A7	H
2T3F-87501-630	767	920	1100	630	6SE0180-2BD38-8 ■ A7	H
2T3F-87501-710	849	1030	1230	710	6SE0180-2BD41-0 ■ A7	H
2T3F-87501-800	944	1150	1380	800	6SE0180-2BD41-1 ■ A7	H

See article number code on Page 3/48.

Notice:

The 500 V, 12-pulse, air-cooled version of the SINAMICS G180 cabinet unit is normally operated on a three-winding transformer. This transformer can be ordered as a separate item on request. This version of the cabinet unit could also operate on a shift transformer.

Please ask your Siemens contact person for further advice.

¹⁾ Short-time current for 60 s every 10 minutes.

²⁾ Rated power of a typical 2- to 6-pole standard motor.

Selection and ordering data (continued)

690 V, 6-pulse

SINAMICS G180 cabinet unit (400 to 600/690 V 3 AC TN/TT system, 50 to 60 Hz)¹⁾

Converter type	Connected load kVA	Output		Type rating ³⁾ kW	SINAMICS G180 cabinet units, air-cooled Article No.	Version (for option selection)
		Continuous current A	Short-time current ²⁾ A			
2T3A-87601-250	312	270	320	250	6SE0180-1BG33-2 ■ A7	I
2T3A-87601-315	391	340	410	315	6SE0180-1BG33-6 ■ A7	I
2T3A-87601-400	502	440	510	400	6SE0180-1BG34-2 ■ A7	J
2T3A-87601-500	608	530	640	500	6SE0180-1BG35-2 ■ A7	K
2T3A-87601-560	676	590	710	560	6SE0180-1BG35-7 ■ A7	K
2T3A-87601-630	764	660	800	630	6SE0180-1BG36-4 ■ A7	K
2T3A-87601-710	854	750	890	710	6SE0180-1BG37-1 ■ A7	K
2T3A-87601-800	956	840	980	800	6SE0180-1BG37-7 ■ A7	K
2T3A-87601-909	1078	950	1060	900	6SE0180-1BG41-0 ■ A7	K
2T3A-87601-910	1165	1040	1130	1000	6SE0180-1BG41-1 ■ A7	K
2T3A-87602-912	1410	1260	1520	1200	6SE0180-1CG41-2 ■ A7	K
2T3A-87602-913	1603	1430	1700	1300	6SE0180-1CG41-3 ■ A7	K
2T3A-87602-915	1795	1600	1870	1500	6SE0180-1CG41-5 ■ A7	K
2T3A-87602-917	2030	1810	2020	1700	6SE0180-1CG41-7 ■ A7	K
2T3A-87602-919	2220	1980	2150	1900	6SE0180-1CG42-0 ■ A7	K

See article number code on Page 3/48.

SINAMICS G180 cabinet unit (400 to 600/690 V 3 AC IT system, 50 to 60 Hz)¹⁾

Converter type	Connected load kVA	Output		Type rating ³⁾ kW	SINAMICS G180 cabinet units, air-cooled Article No.	Version (for option selection)
		Continuous current A	Short-time current ²⁾ A			
2T3A-87601-250	312	270	320	250	6SE0180-1BH33-2 ■ A7	L
2T3A-87601-315	391	340	410	315	6SE0180-1BH33-6 ■ A7	L
2T3A-87601-400	502	440	510	400	6SE0180-1BH34-2 ■ A7	M
2T3A-87601-500	608	530	640	500	6SE0180-1BH35-2 ■ A7	N
2T3A-87601-560	676	590	710	560	6SE0180-1BH35-7 ■ A7	N
2T3A-87601-630	764	660	800	630	6SE0180-1BH36-4 ■ A7	N
2T3A-87601-710	854	750	890	710	6SE0180-1BH37-1 ■ A7	N
2T3A-87601-800	956	840	980	800	6SE0180-1BH37-7 ■ A7	N
2T3A-87601-909	1078	950	1060	900	6SE0180-1BH41-0 ■ A7	N
2T3A-87601-910	1165	1040	1130	1000	6SE0180-1BH41-1 ■ A7	N
2T3A-87602-912	1410	1260	1520	1200	6SE0180-1CH41-2 ■ A7	N
2T3A-87602-913	1603	1430	1700	1300	6SE0180-1CH41-3 ■ A7	N
2T3A-87602-915	1795	1600	1870	1500	6SE0180-1CH41-5 ■ A7	N
2T3A-87602-917	2030	1810	2020	1700	6SE0180-1CH41-7 ■ A7	N
2T3A-87602-919	2220	1980	2150	1900	6SE0180-1CH42-0 ■ A7	N

See article number code on Page 3/48.

¹⁾ With an NRTL unit ("U" in 14th position of article number), the voltage range ends at maximum 600 V, otherwise at 690 V.

³⁾ Rated power of a typical 2- to 6-pole standard motor.

²⁾ Short-time current for 60 s every 10 minutes.

SINAMICS G180

SINAMICS G180 cabinet units

SINAMICS G180 cabinet units air-cooled

Selection and ordering data (continued)

690 V, 12-pulse

SINAMICS G180 cabinet unit (2 × 400 to 600/690 V 3 AC IT system, 50 to 60 Hz)¹⁾

Converter type	Connected load kVA	Output			SINAMICS G180 cabinet units, air-cooled Article No.	Version (for option selection)
		Continuous current A	Short-time current ²⁾ A	Type rating ³⁾ kW		
2T3F-87601-250	311	270	320	250	6SE0180-2BH33-2 ■ A7	O
2T3F-87601-315	392	340	410	315	6SE0180-2BH33-6 ■ A7	O
2T3F-87601-400	502	440	510	400	6SE0180-2BH34-2 ■ A7	O
2T3F-87601-500	600	530	640	500	6SE0180-2BH35-2 ■ A7	O
2T3F-87601-560	667	590	710	560	6SE0180-2BH35-7 ■ A7	O
2T3F-87601-630	755	660	800	630	6SE0180-2BH36-4 ■ A7	O
2T3F-87601-710	848	750	890	710	6SE0180-2BH37-1 ■ A7	O
2T3F-87601-800	949	840	980	800	6SE0180-2BH37-7 ■ A7	O
2T3F-87601-909	1071	950	1060	900	6SE0180-2BH41-0 ■ A7	O
2T3F-87601-910	1159	1040	1130	1000	6SE0180-2BH41-1 ■ A7	O
2T3F-87602-912	1405	1260	1520	1200	6SE0180-2CH41-2 ■ A7	O
2T3F-87602-913	1597	1430	1700	1300	6SE0180-2CH41-3 ■ A7	O
2T3F-87602-915	1781	1600	1870	1500	6SE0180-2CH41-5 ■ A7	O
2T3F-87602-917	2010	1810	2020	1700	6SE0180-2CH41-7 ■ A7	O
2T3F-87602-919	2194	1980	2150	1900	6SE0180-2CH42-0 ■ A7	O
2T3F-87603-920	2369	2140	2540	2000	6SE0180-2DH42-2 ■ A7	O
2T3F-87603-923	2648	2400	2800	2300	6SE0180-2DH42-4 ■ A7	O
2T3F-87603-926	2983	2710	3030	2600	6SE0180-2DH42-7 ■ A7	O
2T3F-87603-929	3272	2970	3230	2900	6SE0180-2DH43-0 ■ A7	O
2T3F-87604-931	3516	3200	3730	3100	6SE0180-2EH43-2 ■ A7	O
2T3F-87604-935	3956	3610	4030	3500	6SE0180-2EH43-6 ■ A7	O
2T3F-87604-939	4336	3960	4300	3900	6SE0180-2EH44-0 ■ A7	O

See article number code on Page 3/48.

Notice:

The 690 V, 12-pulse, air-cooled version of the SINAMICS G180 cabinet unit is normally operated on a three-winding transformer. This transformer can be ordered as a separate item on request. This version of the cabinet unit could also operate on a shift transformer.

Please ask your Siemens contact person for further advice.

690 V, 18-pulse

SINAMICS G180 cabinet unit (3 × 400 to 600/690 V 3 AC IT system, 50 to 60 Hz)¹⁾

Converter type	Connected load kVA	Output			SINAMICS G180 cabinet units, air-cooled Article No.	Version (for option selection)
		Continuous current A	Short-time current ²⁾ A	Type rating ³⁾ kW		
2T3K-87603-920	2369	2140	2540	2000	6SE0180-3DH42-2 ■ A7	O
2T3K-87603-923	2648	2400	2800	2300	6SE0180-3DH42-4 ■ A7	O
2T3K-87603-926	2983	2710	3030	2600	6SE0180-3DH42-7 ■ A7	O
2T3K-87603-929	3272	2970	3230	2900	6SE0180-3DH43-0 ■ A7	O
2T3K-87606-941	4692	4290	5100	4100	6SE0180-3HH44-3 ■ A7	O
2T3K-87606-947	5244	4800	5610	4700	6SE0180-3HH44-8 ■ A7	O
2T3K-87606-953	5916	5420	6040	5300	6SE0180-3HH45-4 ■ A7	O
2T3K-87606-958	6482	5940	6450	5800	6SE0180-3HH46-0 ■ A7	O

See article number code on Page 3/48.

¹⁾ With an NRTL unit ("U" in 14th position of article number), the voltage range ends at maximum 600 V, otherwise at 690 V. ³⁾ Rated power of a typical 2- to 6-pole standard motor.

²⁾ Short-time current for 60 s every 10 minutes.

Selection and ordering data (continued)

690 V, 24-pulse

SINAMICS G180 cabinet unit (4 × 400 to 600/690 V 3 AC IT system, 50 to 60 Hz)¹⁾

Converter type	Connected load kVA	Output		Type rating ³⁾ kW	SINAMICS G180 cabinet units, air-cooled Article No.	Version (for option selection)
		Continuous current A	Short-time current ²⁾ A			
2T3L-87602-912	1405	1260	1520	1200	6SE0180-4CH41-2 ■ A7	O
2T3L-87602-913	1597	1430	1700	1300	6SE0180-4CH41-3 ■ A7	O
2T3L-87602-915	1781	1600	1870	1500	6SE0180-4CH41-5 ■ A7	O
2T3L-87602-917	2010	1810	2020	1700	6SE0180-4CH41-7 ■ A7	O
2T3L-87602-919	2194	1980	2150	1900	6SE0180-4CH42-0 ■ A7	O
2T3L-87604-931	3516	3200	3730	3100	6SE0180-4EH43-2 ■ A7	O
2T3L-87604-935	3956	3610	4030	3500	6SE0180-4EH43-6 ■ A7	O
2T3L-87604-939	4336	3960	4300	3900	6SE0180-4EH44-0 ■ A7	O
2T3L-87606-941	4692	4290	5100	4100	6SE0180-4HH44-3 ■ A7	O
2T3L-87606-947	5244	4800	5610	4700	6SE0180-4HH44-8 ■ A7	O
2T3L-87606-953	5916	5420	6040	5300	6SE0180-4HH45-4 ■ A7	O
2T3L-87606-958	6482	5940	6450	5800	6SE0180-4HH46-0 ■ A7	O

See article number code on Page 3/48.

¹⁾ With an NRTL unit ("U" in 14th position of article number), the voltage range ends at maximum 600 V, otherwise at 690 V.

²⁾ Short-time current for 60 s every 10 minutes.

³⁾ Rated power of a typical 2- to 6-pole standard motor.

SINAMICS G180

SINAMICS G180 cabinet units

SINAMICS G180 cabinet units
air-cooled

Dimensional drawings

Frame size SL2

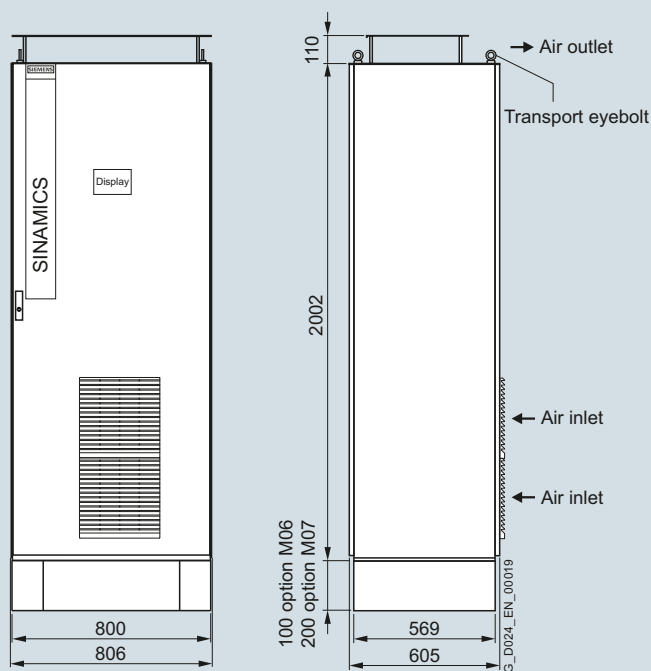

Dimensional drawing applies to standard converters without options. The cabinet dimensions might change if options are selected.

SINAMICS G180 cabinet units, air-cooled	<i>Converter type</i>
6SE0180-1BA33-7■A7	2T3A-87401-200
6SE0180-1BA34-6■A7	2T3A-87401-250
6SE0180-1BA36-3■A7	2T3A-87401-315
6SE0180-1BD33-7■A7	2T3A-87501-250
6SE0180-1BD34-6■A7	2T3A-87501-315
6SE0180-1BD36-0■A7	2T3A-87501-400
6SE0180-1B■33-2■A7	2T3A-87601-250
6SE0180-1B■33-6■A7	2T3A-87601-315
6SE0180-1B■34-2■A7	2T3A-87601-400

Dimensional drawings (continued)

Frame size SL21

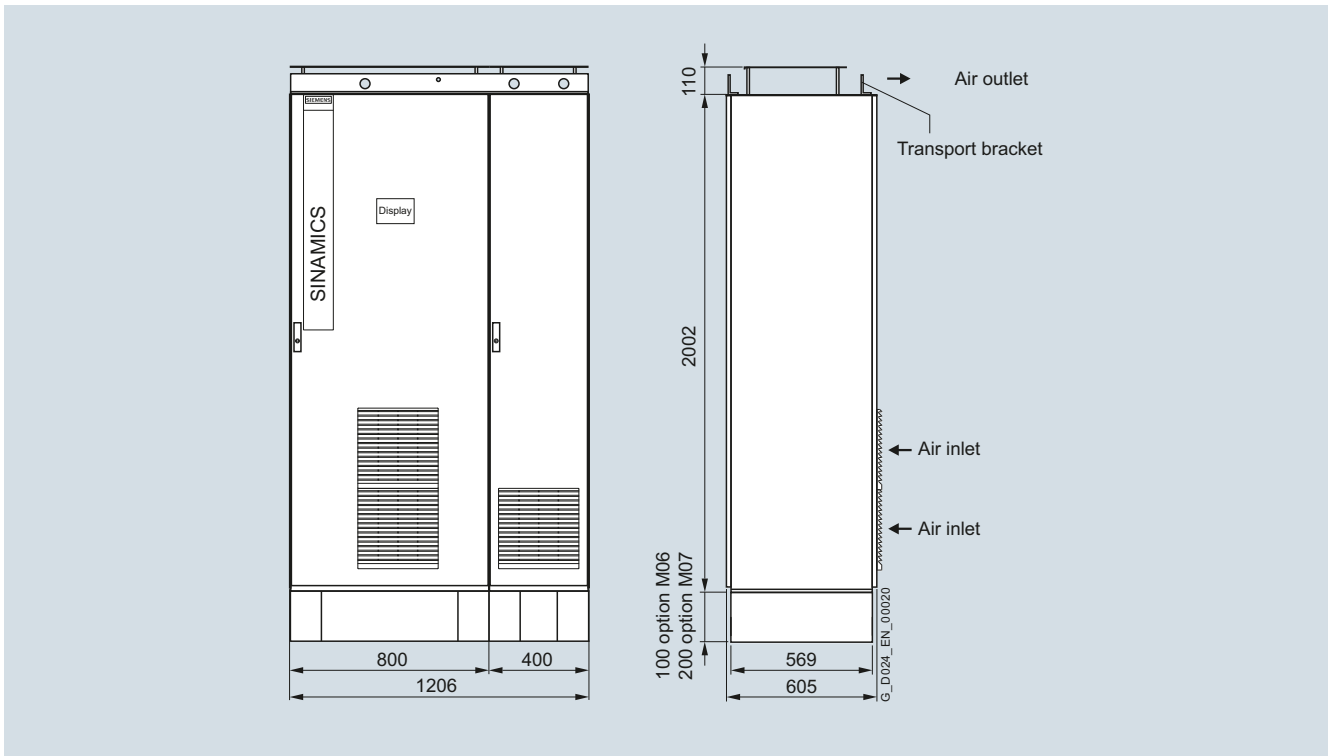

Dimensional drawing applies to standard converters without options. The cabinet dimensions might change if options are selected.

SINAMICS G180 cabinet units, air-cooled	<i>Converter type</i>
6SE0180-1BA37-3■A7	2T3A-87401-400
6SE0180-1BD37-3■A7	2T3A-87501-500
6SE0180-1B■35-2■A7	2T3A-87601-500

SINAMICS G180

SINAMICS G180 cabinet units

SINAMICS G180 cabinet units
air-cooled

Dimensional drawings (continued)

Frame size SL3

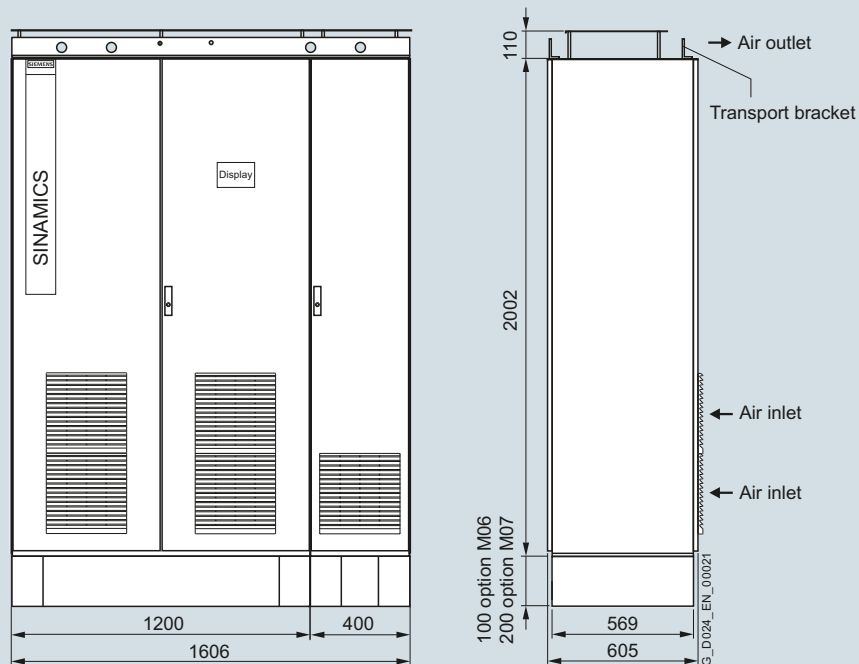

Dimensional drawing applies to standard converters without options. The cabinet dimensions might change if options are selected.

SINAMICS G180 cabinet units, air-cooled	Converter type
6SE0180-1BA38-8■A7	2T3A-87401-500
6SE0180-1BA41-0■A7	2T3A-87401-560
6SE0180-1BA41-1■A7	2T3A-87401-630
6SE0180-1BD38-2■A7	2T3A-87501-560
6SE0180-1BD38-8■A7	2T3A-87501-630
6SE0180-1BD41-0■A7	2T3A-87501-710
6SE0180-1BD41-1■A7	2T3A-87501-800
6SE0180-1B■35-7■A7	2T3A-87601-560
6SE0180-1B■36-4■A7	2T3A-87601-630
6SE0180-1B■37-1■A7	2T3A-87601-710
6SE0180-1B■37-7■A7	2T3A-87601-800
6SE0180-1B■41-0■A7	2T3A-87601-909
6SE0180-1B■41-1■A7	2T3A-87601-910

Dimensional drawings (continued)

Frame size SL4

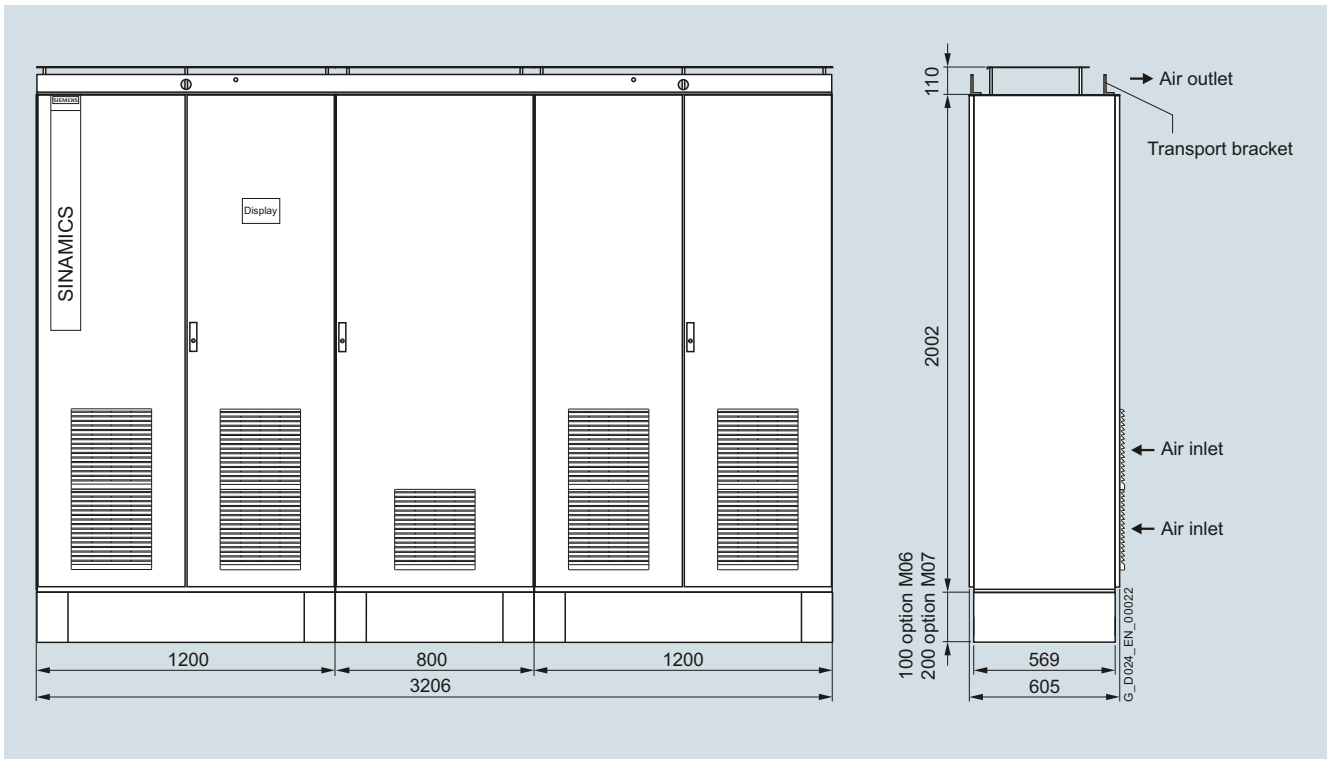

Dimensional drawing applies to standard converters without options. The cabinet dimensions might change if options are selected.

SINAMICS G180 cabinet units, air-cooled	Converter type
6SE0180-1C41-2A7	2T3A-87602-912
6SE0180-1C41-3A7	2T3A-87602-913
6SE0180-1C41-5A7	2T3A-87602-915
6SE0180-1C41-7A7	2T3A-87602-917
6SE0180-1C42-0A7	2T3A-87602-919
6SE0180-2CH41-2A7	2T3F-87602-912
6SE0180-2CH41-3A7	2T3F-87602-913
6SE0180-2CH41-5A7	2T3F-87602-915
6SE0180-2CH41-7A7	2T3F-87602-917
6SE0180-2CH42-0A7	2T3F-87602-919

SINAMICS G180

SINAMICS G180 cabinet units

SINAMICS G180 cabinet units
air-cooled

Dimensional drawings (continued)

Frame size SL5

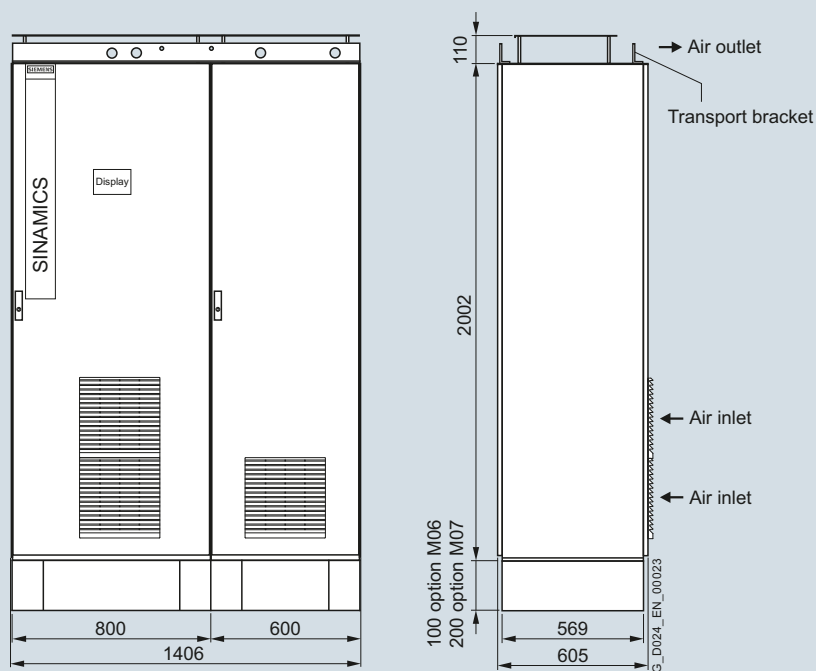

Dimensional drawing applies to standard converters without options. The cabinet dimensions might change if options are selected.

SINAMICS G180 cabinet units, air-cooled	Converter type
6SE0180-2BA33-7■A7	2T3F-87401-200
6SE0180-2BA34-6■A7	2T3F-87401-250
6SE0180-2BA36-3■A7	2T3F-87401-315
6SE0180-2BA37-3■A7	2T3F-87401-400
6SE0180-2BD33-7■A7	2T3F-87501-250
6SE0180-2BD34-6■A7	2T3F-87501-315
6SE0180-2BD36-3■A7	2T3F-87501-400
6SE0180-2BD37-3■A7	2T3F-87501-500
6SE0180-2BH33-2■A7	2T3F-87601-250
6SE0180-2BH33-6■A7	2T3F-87601-315
6SE0180-2BH34-2■A7	2T3F-87601-400
6SE0180-2BH35-2■A7	2T3F-87601-500

Dimensional drawings (continued)

Frame size SL6

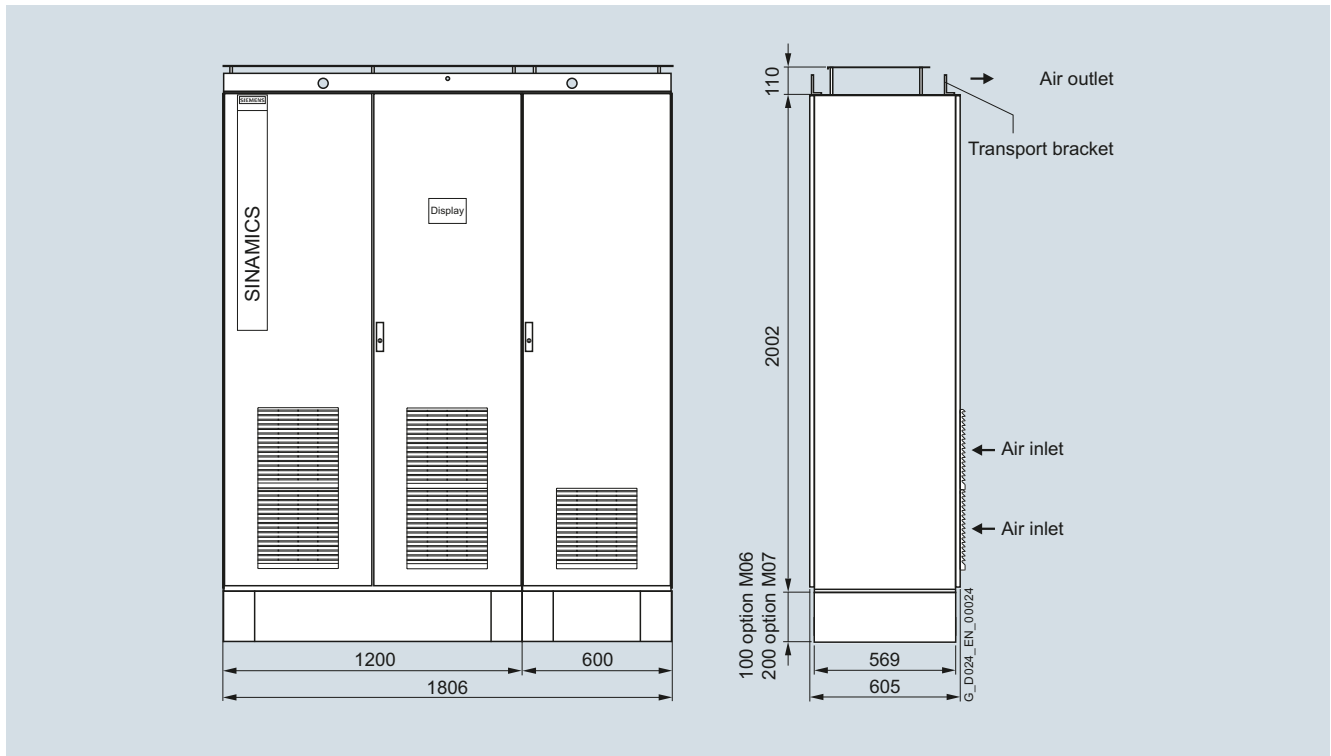

Dimensional drawing applies to standard converters without options. The cabinet dimensions might change if options are selected.

SINAMICS G180 cabinet units, air-cooled	<i>Converter type</i>
6SE0180-2BA38-8■A7	2T3F-87401-500
6SE0180-2BA41-0■A7	2T3F-87401-560
6SE0180-2BA41-1■A7	2T3F-87401-630
6SE0180-2BD38-2■A7	2T3F-87501-560
6SE0180-2BD38-8■A7	2T3F-87501-630
6SE0180-2BD41-0■A7	2T3F-87501-710
6SE0180-2BD41-1■A7	2T3F-87501-800
6SE0180-2BH35-7■A7	2T3F-87601-560
6SE0180-2BH36-4■A7	2T3F-87601-630
6SE0180-2BH37-1■A7	2T3F-87601-710
6SE0180-2BH37-7■A7	2T3F-87601-800
6SE0180-2BH41-0■A7	2T3F-87601-909
6SE0180-2BH41-1■A7	2T3F-87601-910

SINAMICS G180

SINAMICS G180 cabinet units

SINAMICS G180 cabinet units
air-cooled

Dimensional drawings (continued)

Frame size SL7

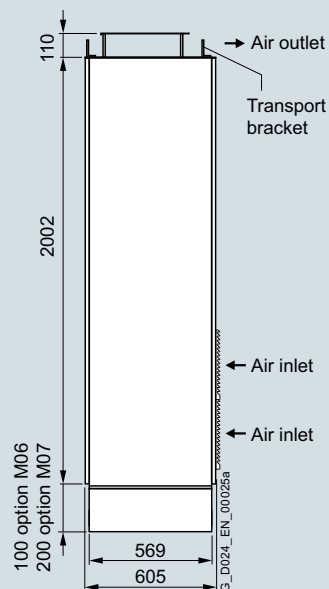
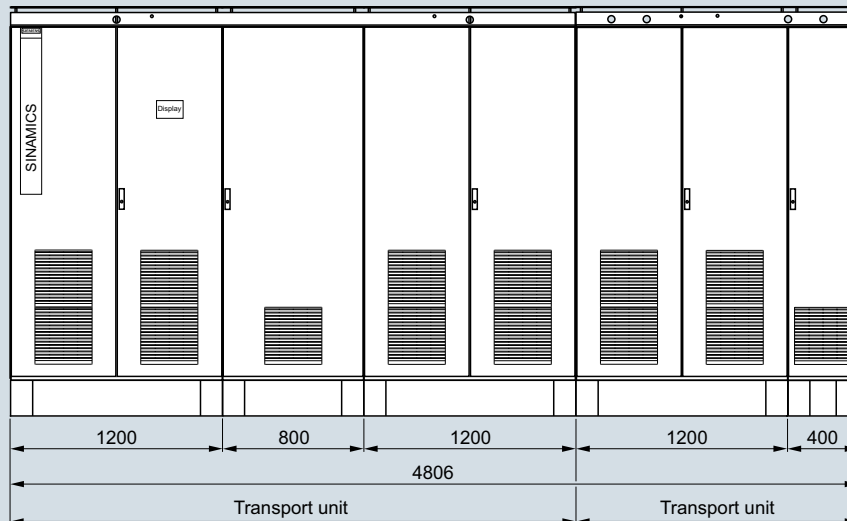

Dimensional drawing applies to standard converters without options. The cabinet dimensions might change if options are selected.

SINAMICS G180 cabinet units, air-cooled	Converter type
6SE0180-2DH42-2■A7	2T3F-87603-920
6SE0180-2DH42-4■A7	2T3F-87603-923
6SE0180-2DH42-7■A7	2T3F-87603-926
6SE0180-2DH43-0■A7	2T3F-87603-929
6SE0180-3DH42-2■A7	2T3K-87603-920
6SE0180-3DH42-4■A7	2T3K-87603-923
6SE0180-3DH42-7■A7	2T3K-87603-926
6SE0180-3DH43-0■A7	2T3K-87603-929

Dimensional drawings (continued)

Frame size SL8

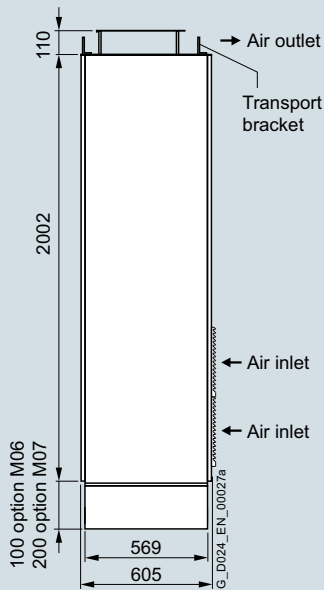
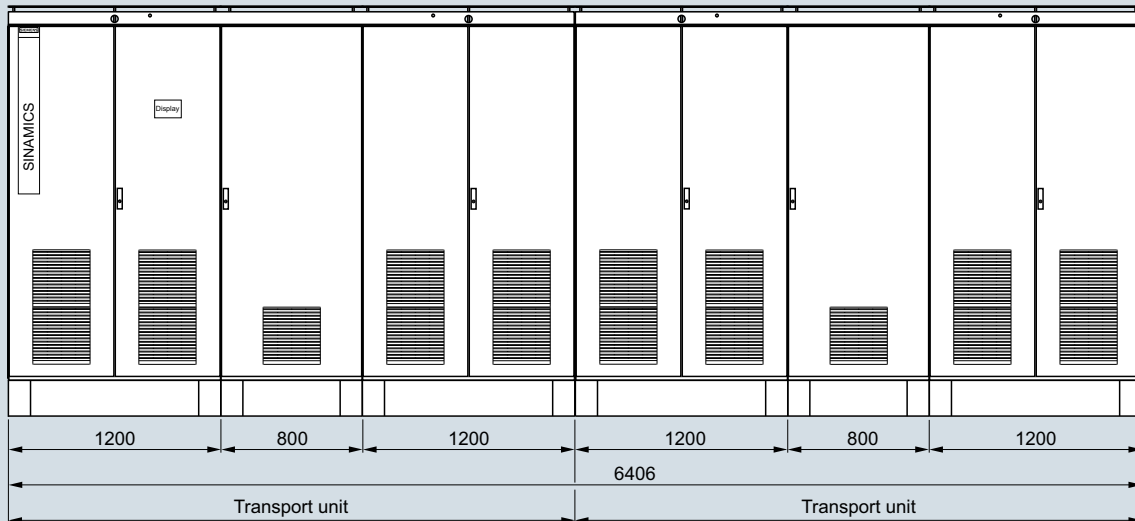

Dimensional drawing applies to standard converters without options. The cabinet dimensions might change if options are selected.

SINAMICS G180 cabinet units, air-cooled	Converter type
6SE0180-2EH43-2■A7	2T3F-87604-931
6SE0180-2EH43-6■A7	2T3F-87604-935
6SE0180-2EH44-0■A7	2T3F-87604-939

SINAMICS G180

SINAMICS G180 cabinet units

SINAMICS G180 cabinet units
air-cooled

Dimensional drawings (continued)

Frame size SL9

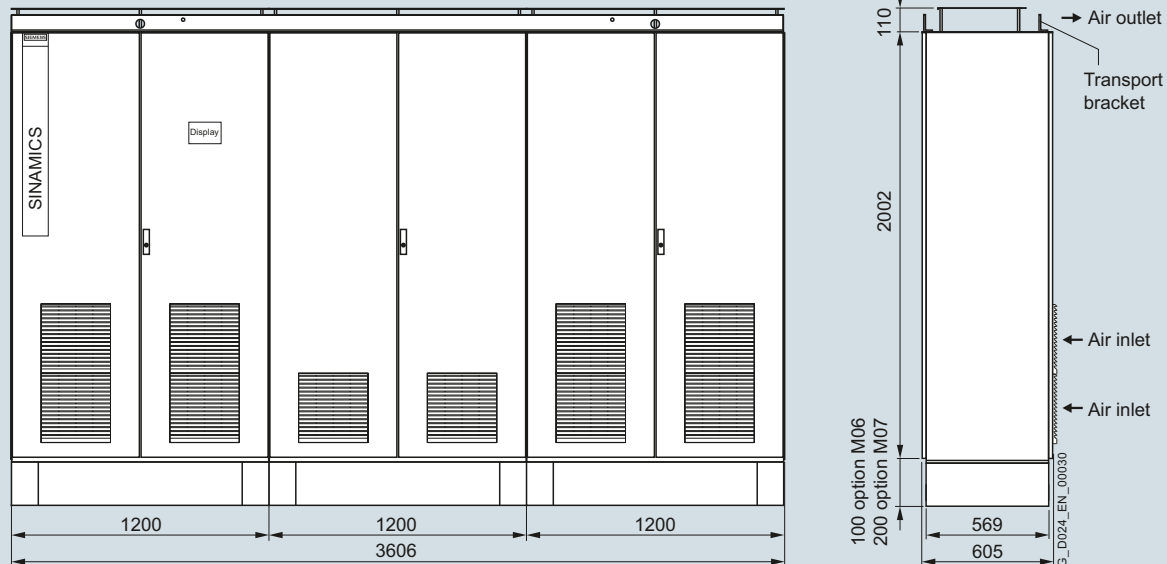

Dimensional drawing applies to standard converters without options. The cabinet dimensions might change if options are selected.

SINAMICS G180 cabinet units, air-cooled	Converter type
6SE0180-4CH41-2■A7	2T3L-87602-912
6SE0180-4CH41-3■A7	2T3L-87602-913
6SE0180-4CH41-5■A7	2T3L-87602-915
6SE0180-4CH41-7■A7	2T3L-87602-917
6SE0180-4CH42-0■A7	2T3L-87602-919

Dimensional drawings (continued)

Frame size SL10

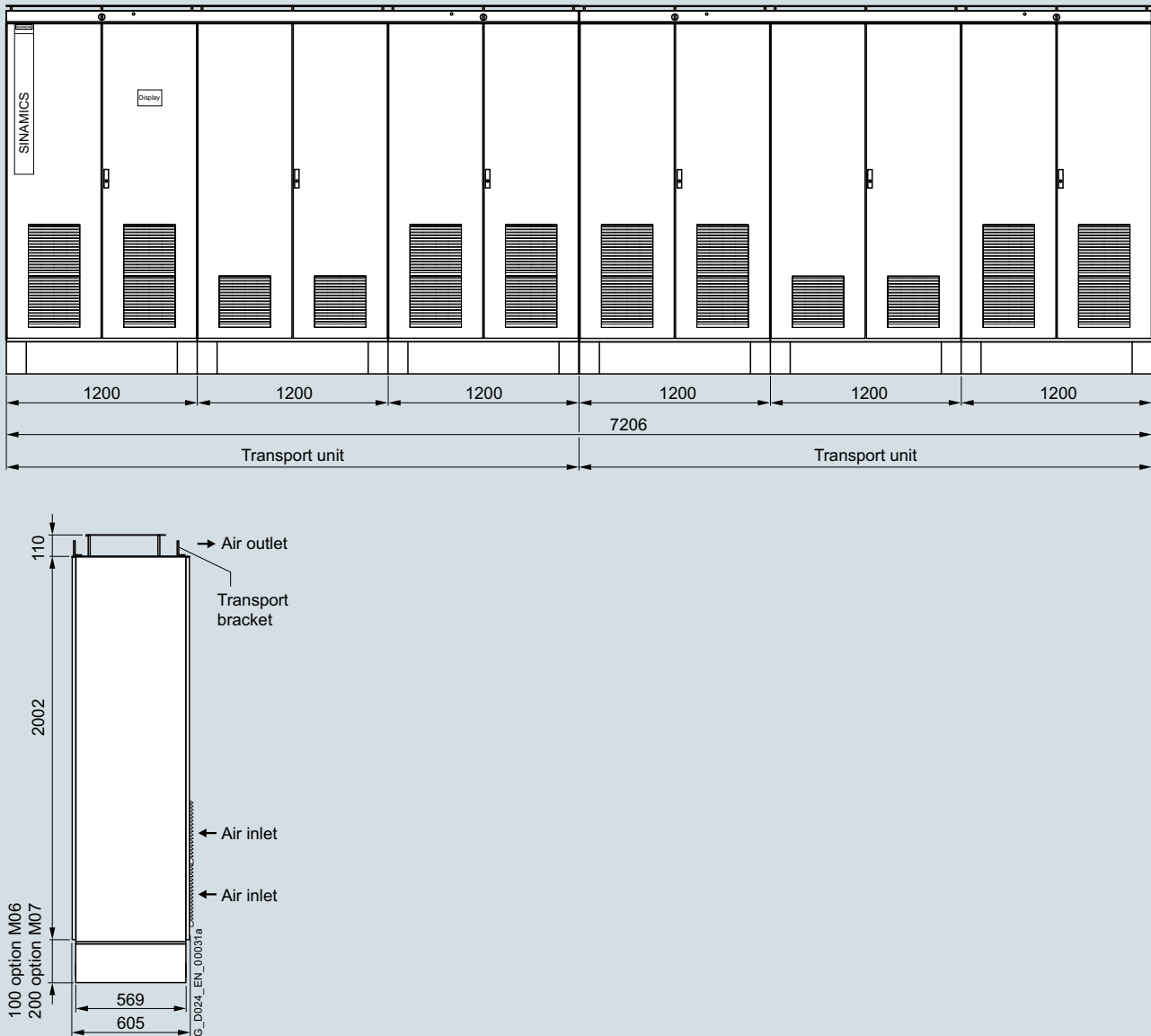

Dimensional drawing applies to standard converters without options. The cabinet dimensions might change if options are selected.

SINAMICS G180 cabinet units, air-cooled	Converter type
6SE0180-4EH43-2■A7	2T3L-87604-931
6SE0180-4EH43-6■A7	2T3L-87604-935
6SE0180-4EH44-0■A7	2T3L-87604-939

SINAMICS G180

SINAMICS G180 cabinet units

SINAMICS G180 cabinet units
air-cooled

Dimensional drawings (continued)

Frame size SL11

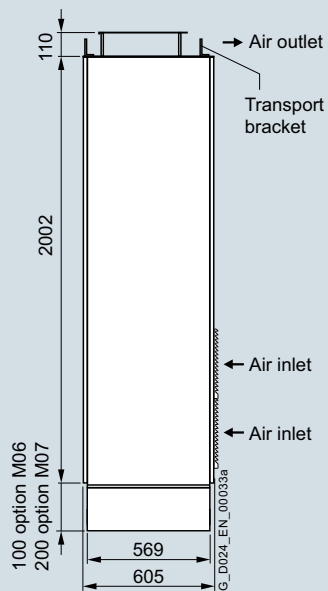
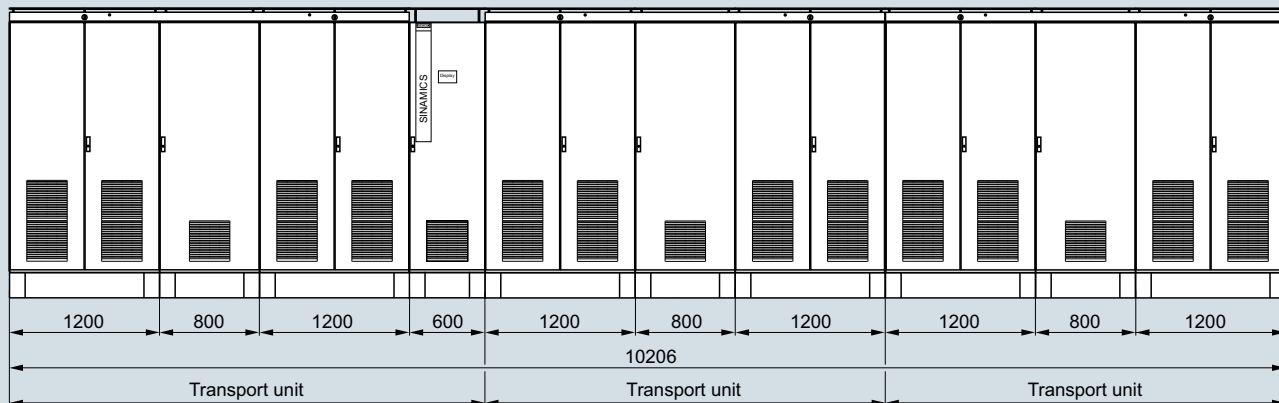

Dimensional drawing applies to standard converters without options. The cabinet dimensions might change if options are selected.

SINAMICS G180 cabinet units, air-cooled	Converter type
6SE0180-3HH44-3■A7	2T3K-87606-941
6SE0180-3HH44-8■A7	2T3K-87606-947
6SE0180-3HH45-4■A7	2T3K-87606-953
6SE0180-3HH46-0■A7	2T3K-87606-958

Dimensional drawings (continued)

Frame size SL12

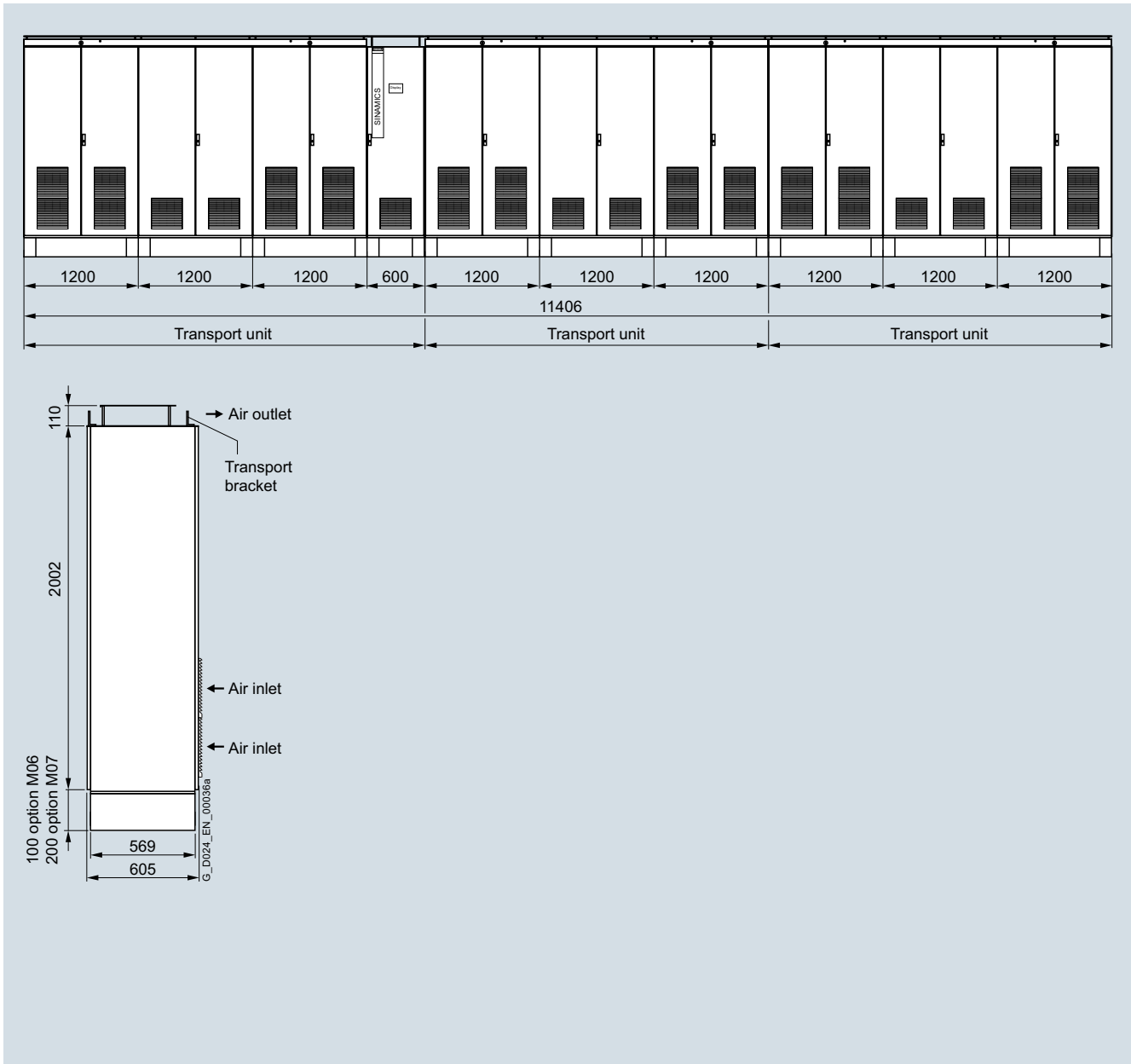

3

Dimensional drawing applies to standard converters without options. The cabinet dimensions might change if options are selected.

SINAMICS G180 cabinet units, air-cooled	<i>Converter type</i>
6SE0180-4HH44-3■A7	2T3L-87606-941
6SE0180-4HH44-8■A7	2T3L-87606-947
6SE0180-4HH45-4■A7	2T3L-87606-953
6SE0180-4HH46-0■A7	2T3L-87606-958

SINAMICS G180

SINAMICS G180 cabinet units

SINAMICS G180 cabinet units liquid-cooled

Design

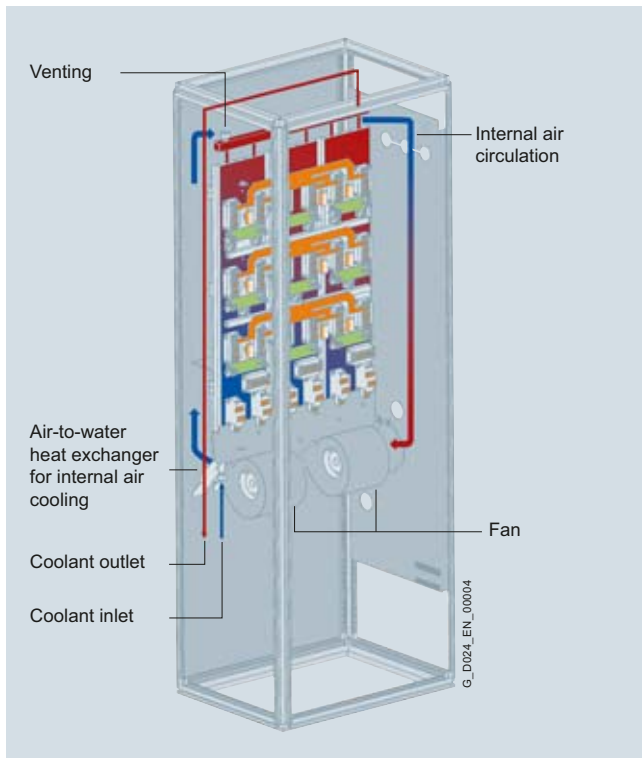

Protection against condensation

With liquid-cooled units, warm air can condense on the cold surfaces of the pipes and heat sink. This condensation depends on the air humidity and the temperature difference between the ambient air and the coolant. The higher the humidity level, the smaller the temperature difference at which condensate will form. The water which is produced as a result of condensation can cause corrosion as well as electrical damage such as creepage shorts and flashovers. The solenoid valve (-Y1) integrated in the converter regulates the coolant temperature according to the temperature of the ambient air and thus effectively protects the unit against condensation.

Design (continued)

Closed cooling circuit for a SINAMICS G180 liquid-cooled converter

The following diagram shows a typical example of a closed cooling circuit with an explanation of all the main cooling circuit components.

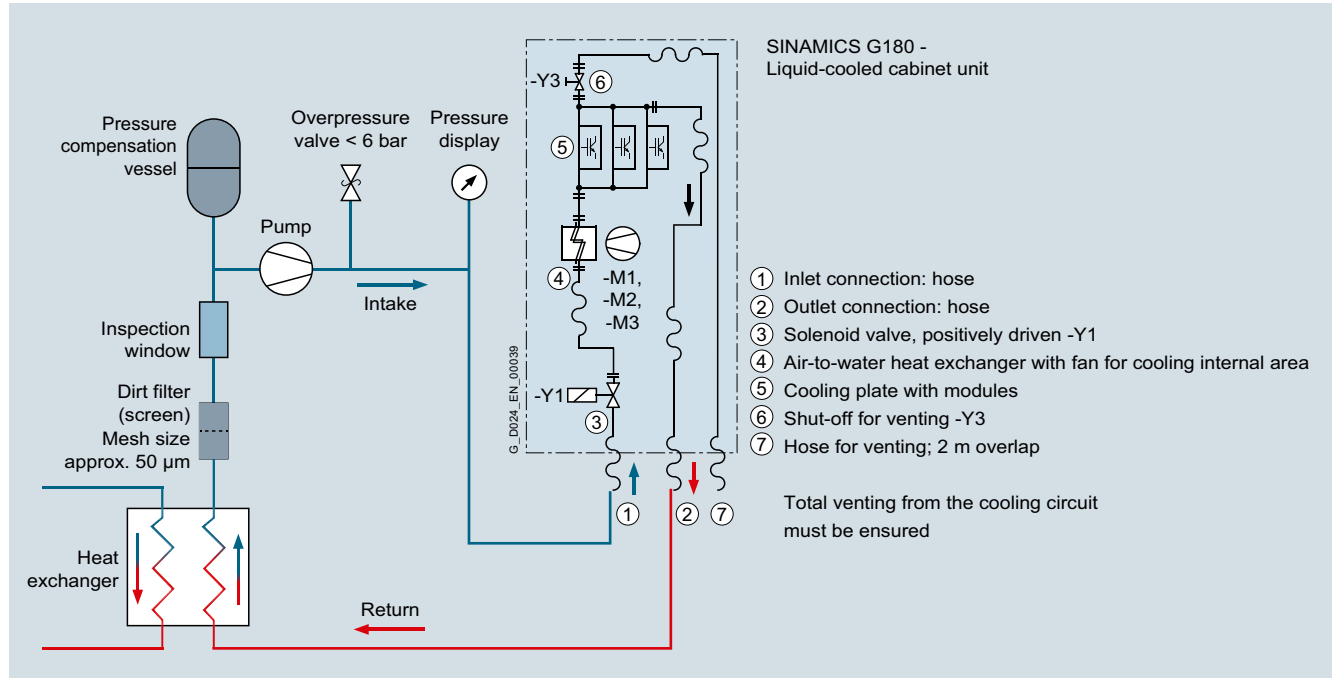

SINAMICS G180 liquid-cooled cabinet unit – recommended layout for a closed cooling circuit

Open cooling circuit for a SINAMICS G180 liquid-cooled converter

The following diagram shows a typical example of an open cooling circuit with an explanation of all the main cooling circuit components.

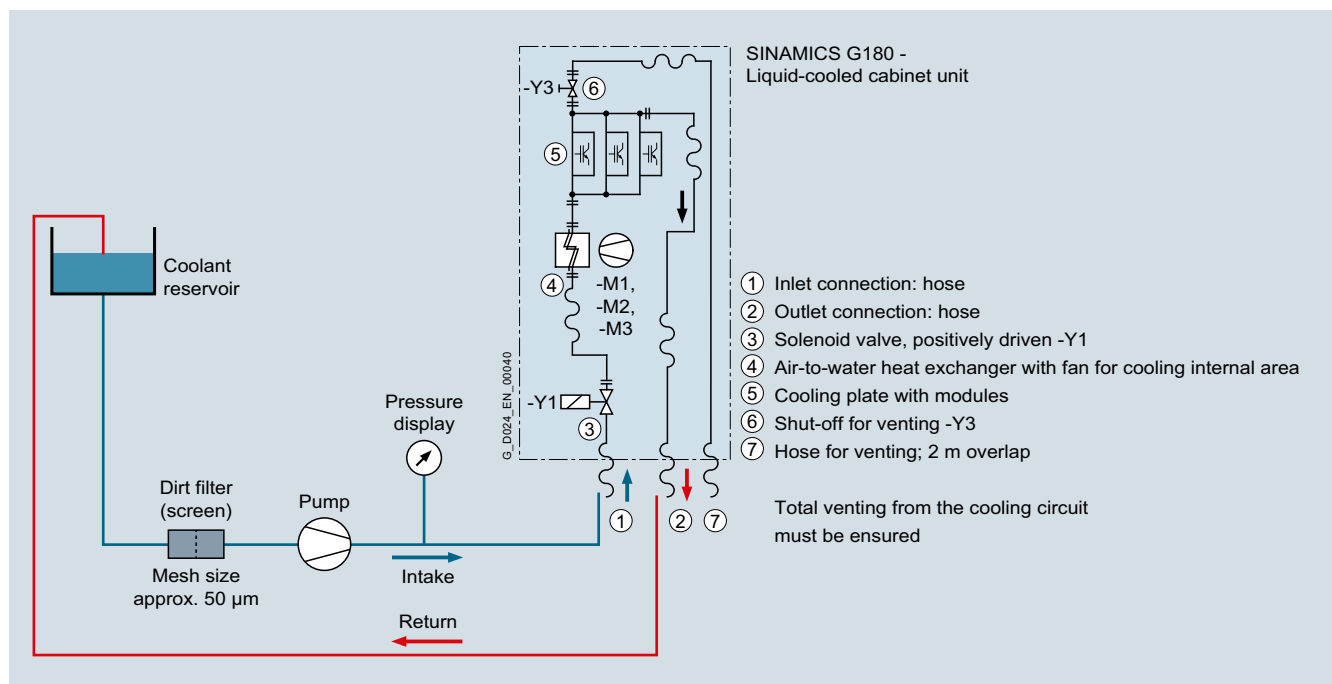

SINAMICS G180 liquid-cooled cabinet unit – recommended layout for an open cooling circuit

SINAMICS G180

SINAMICS G180 cabinet units

SINAMICS G180 cabinet units liquid-cooled

Selection and ordering data

400 V, 6-pulse

SINAMICS G180 cabinet unit (230 to 415 V 3 AC TN/TT system, 50 to 60 Hz)

Converter type	Connected load kVA	Output		Type rating ²⁾ kW	SINAMICS G180 cabinet units, liquid-cooled Article No.	Version (for option selection)
		Continuous current A	Short-time current ¹⁾ A			
2T6A-77401-200	249	380	470	200	6SE0170-1BA33-7 ■ A7	A
2T6A-77401-250	300	460	560	250	6SE0170-1BA34-6 ■ A7	A
2T6A-77401-315	403	630	700	315	6SE0170-1BA36-3 ■ A7	B
2T6A-77401-400	476	740	900	400	6SE0170-1BA37-3 ■ A7	C
2T6A-77401-500	603	910	1110	500	6SE0170-1BA38-8 ■ A7	C
2T6A-77401-560	676	1020	1230	560	6SE0170-1BA41-0 ■ A7	D
2T6A-77401-630	761	1140	1370	630	6SE0170-1BA41-1 ■ A7	D

See article number code on Page 3/48.

400 V, 12-pulse incl. shift transformer

SINAMICS G180 cabinet unit (230 to 415 V 3 AC TN/TT system, 50 to 60 Hz)

Converter type	Connected load kVA	Output		Type rating ²⁾ kW	SINAMICS G180 cabinet units, liquid-cooled Article No.	Version (for option selection)
		Continuous current A	Short-time current ¹⁾ A			
2T6F-77401-200	249	380	470	200	6SE0170-2BA33-7 ■ A7	E
2T6F-77401-250	301	460	560	250	6SE0170-2BA34-6 ■ A7	E
2T6F-77401-315	405	630	700	315	6SE0170-2BA36-3 ■ A7	E
2T6F-77401-400	477	740	900	400	6SE0170-2BA37-3 ■ A7	E
2T6F-77401-500	604	910	1110	500	6SE0170-2BA38-8 ■ A7	E
2T6F-77401-560	676	1020	1230	560	6SE0170-2BA41-0 ■ A7	E
2T6F-77401-630	762	1140	1370	630	6SE0170-2BA41-1 ■ A7	E

See article number code on Page 3/48.

Notice:

The 400 V, 12-pulse, liquid-cooled version of the SINAMICS G180 cabinet unit is operated with a shift transformer. In this case, the first system is supplied directly from the mains via the line reactor and the second system via a shift transformer. This shift transformer is supplied as a separately packed item (degree of protection IP00) with the converter. At the customer's request, this transformer can also be installed in a separate control cabinet or in the converter cabinet itself if required.

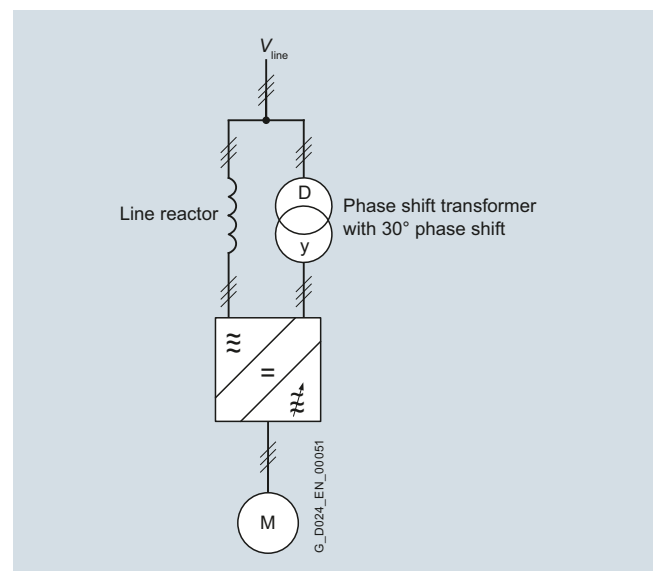

¹⁾ Short-time current for 60 s every 10 minutes.

²⁾ Rated power of a typical 2- to 6-pole standard motor.

Selection and ordering data (continued)

500 V, 6-pulse

SINAMICS G180 cabinet unit (230 to 500 V 3 AC TN/TT system, 50 to 60 Hz)

Converter type	Connected load kVA	Output		Type rating ²⁾ kW	SINAMICS G180 cabinet units, liquid-cooled Article No.	Version (for option selection)
		Continuous current A	Short-time current ¹⁾ A			
2T6A-77501-250	303	370	450	250	6SE0170-1BC33-7 ■ A7	F
2T6A-77501-315	378	460	560	315	6SE0170-1BC34-6 ■ A7	F
2T6A-77501-400	514	640	700	400	6SE0170-1BC36-3 ■ A7	G
2T6A-77501-500	606	730	900	500	6SE0170-1BC37-3 ■ A7	G
2T6A-77501-560	678	820	980	560	6SE0170-1BC38-2 ■ A7	G
2T6A-77501-630	767	920	1100	630	6SE0170-1BC38-8 ■ A7	G
2T6A-77501-710	848	1030	1230	710	6SE0170-1BC41-0 ■ A7	G
2T6A-77501-800	944	1150	1380	800	6SE0170-1BC41-1 ■ A7	G

See article number code on Page 3/48.

SINAMICS G180 cabinet unit (230 to 500 V 3 AC IT system, 50 to 60 Hz)

Converter type	Connected load kVA	Output		Type rating ²⁾ kW	SINAMICS G180 cabinet units, liquid-cooled Article No.	Version (for option selection)
		Continuous current A	Short-time current ¹⁾ A			
2T6A-77501-250	303	370	450	250	6SE0170-1BD33-7 ■ A7	F
2T6A-77501-315	378	460	560	315	6SE0170-1BD34-6 ■ A7	F
2T6A-77501-400	514	640	700	400	6SE0170-1BD36-3 ■ A7	G
2T6A-77501-500	606	730	900	500	6SE0170-1BD37-3 ■ A7	G
2T6A-77501-560	678	820	980	560	6SE0170-1BD38-2 ■ A7	G
2T6A-77501-630	767	920	1100	630	6SE0170-1BD38-8 ■ A7	G
2T6A-77501-710	848	1030	1230	710	6SE0170-1BD41-0 ■ A7	G
2T6A-77501-800	944	1150	1380	800	6SE0170-1BD41-1 ■ A7	G

See article number code on Page 3/48.

500 V, 12-pulse

SINAMICS G180 cabinet unit (2 × 230 to 500 V 3 AC IT system, 50 to 60 Hz)

Converter type	Connected load kVA	Output		Type rating ²⁾ kW	SINAMICS G180 cabinet units, liquid-cooled Article No.	Version (for option selection)
		Continuous current A	Short-time current ¹⁾ A			
2T6F-77501-250	303	370	450	250	6SE0170-2BD33-7 ■ A7	H
2T6F-77501-315	378	460	560	315	6SE0170-2BD34-6 ■ A7	H
2T6F-77501-400	516	640	700	400	6SE0170-2BD36-3 ■ A7	H
2T6F-77501-500	606	730	900	500	6SE0170-2BD37-3 ■ A7	H
2T6F-77501-560	677	820	980	560	6SE0170-2BD38-2 ■ A7	H
2T6F-77501-630	767	920	1100	630	6SE0170-2BD38-8 ■ A7	H
2T6F-77501-710	849	1030	1230	710	6SE0170-2BD41-0 ■ A7	H
2T6F-77501-800	944	1150	1380	800	6SE0170-2BD41-1 ■ A7	H

See article number code on Page 3/48.

Notice:

The 500 V, 12-pulse, liquid-cooled version of the SINAMICS G180 cabinet unit is normally operated on a three-winding transformer. This transformer can be ordered as a separate item on request. This version of the cabinet unit could also operate on a shift transformer.

Please ask your Siemens contact person for further advice.

¹⁾ Short-time current for 60 s every 10 minutes.

²⁾ Rated power of a typical 2- to 6-pole standard motor.

SINAMICS G180

SINAMICS G180 cabinet units

SINAMICS G180 cabinet units liquid-cooled

Selection and ordering data (continued)

690 V, 6-pulse

SINAMICS G180 cabinet unit (400 to 600/690 V 3 AC TN/TT system, 50 to 60 Hz)¹⁾

Converter type	Connected load kVA	Output		Type rating ³⁾ kW	SINAMICS G180 cabinet units, liquid-cooled Article No.	Version (for option selection)
		Continuous current A	Short-time current ²⁾ A			
2T6A-77601-250	312	270	320	250	6SE0170-1BG33-2 ■ A7	I
2T6A-77601-315	391	340	410	315	6SE0170-1BG33-6 ■ A7	I
2T6A-77601-400	502	440	510	400	6SE0170-1BG34-2 ■ A7	J
2T6A-77601-500	608	530	640	500	6SE0170-1BG35-2 ■ A7	K
2T6A-77601-560	676	590	710	560	6SE0170-1BG35-7 ■ A7	K
2T6A-77601-630	764	660	800	630	6SE0170-1BG36-4 ■ A7	K
2T6A-77601-710	854	750	890	710	6SE0170-1BG37-1 ■ A7	K
2T6A-77601-800	956	840	980	800	6SE0170-1BG37-7 ■ A7	K
2T6A-77601-909	1078	950	1060	900	6SE0170-1BG41-0 ■ A7	K
2T6A-77601-910	1165	1040	1130	1000	6SE0170-1BG41-1 ■ A7	K
2T6A-77602-912	1410	1260	1520	1200	6SE0170-1CG41-2 ■ A7	K
2T6A-77602-913	1603	1430	1700	1300	6SE0170-1CG41-3 ■ A7	K
2T6A-77602-915	1795	1600	1870	1500	6SE0170-1CG41-5 ■ A7	K
2T6A-77602-917	2030	1810	2020	1700	6SE0170-1CG41-7 ■ A7	K
2T6A-77602-919	2220	1980	2150	1900	6SE0170-1CG42-0 ■ A7	K

See article number code on Page 3/48.

SINAMICS G180 cabinet unit (400 to 600/690 V 3 AC IT system, 50 to 60 Hz)¹⁾

Converter type	Connected load kVA	Output		Type rating ³⁾ kW	SINAMICS G180 cabinet units, liquid-cooled Article No.	Version (for option selection)
		Continuous current A	Short-time current ²⁾ A			
2T6A-77601-250	312	270	320	250	6SE0170-1BH33-2 ■ A7	L
2T6A-77601-315	391	340	410	315	6SE0170-1BH33-6 ■ A7	L
2T6A-77601-400	502	440	510	400	6SE0170-1BH34-2 ■ A7	M
2T6A-77601-500	608	530	640	500	6SE0170-1BH35-2 ■ A7	N
2T6A-77601-560	676	590	710	560	6SE0170-1BH35-7 ■ A7	N
2T6A-77601-630	764	660	800	630	6SE0170-1BH36-4 ■ A7	N
2T6A-77601-710	854	750	890	710	6SE0170-1BH37-1 ■ A7	N
2T6A-77601-800	956	840	980	800	6SE0170-1BH37-7 ■ A7	N
2T6A-77601-909	1078	950	1060	900	6SE0170-1BH41-0 ■ A7	N
2T6A-77601-910	1165	1040	1130	1000	6SE0170-1BH41-1 ■ A7	N
2T6A-77602-912	1410	1260	1520	1200	6SE0170-1CH41-2 ■ A7	N
2T6A-77602-913	1603	1430	1700	1300	6SE0170-1CH41-3 ■ A7	N
2T6A-77602-915	1795	1600	1870	1500	6SE0170-1CH41-5 ■ A7	N
2T6A-77602-917	2030	1810	2020	1700	6SE0170-1CH41-7 ■ A7	N
2T6A-77602-919	2220	1980	2150	1900	6SE0170-1CH42-0 ■ A7	N

See article number code on Page 3/48.

¹⁾ With an NRTL unit ("U" in 14th position of article number), the voltage range ends at maximum 600 V, otherwise at 690 V.

³⁾ Rated power of a typical 2- to 6-pole standard motor.

²⁾ Short-time current for 60 s every 10 minutes.

Selection and ordering data (continued)

690 V, 12-pulse

SINAMICS G180 cabinet unit (2 × 400 to 600/690 V 3 AC IT system, 50 to 60 Hz)¹⁾

Converter type	Connected load kVA	Output		Type rating ³⁾ kW	SINAMICS G180 cabinet units, liquid-cooled Article No.	Version (for option selection)
		Continuous current A	Short-time current ²⁾ A			
2T6F-77601-250	311	270	320	250	6SE0170-2BH33-2 ■ A7	O
2T6F-77601-315	392	340	410	315	6SE0170-2BH33-6 ■ A7	O
2T6F-77601-400	502	440	510	400	6SE0170-2BH34-2 ■ A7	O
2T6F-77601-500	600	530	640	500	6SE0170-2BH35-2 ■ A7	O
2T6F-77601-560	667	590	710	560	6SE0170-2BH35-7 ■ A7	O
2T6F-77601-630	755	660	800	630	6SE0170-2BH36-4 ■ A7	O
2T6F-77601-710	848	750	890	710	6SE0170-2BH37-1 ■ A7	O
2T6F-77601-800	949	840	980	800	6SE0170-2BH37-7 ■ A7	O
2T6F-77601-909	1071	950	1060	900	6SE0170-2BH41-0 ■ A7	O
2T6F-77601-910	1159	1040	1130	1000	6SE0170-2BH41-1 ■ A7	O
2T6F-77602-912	1405	1260	1520	1200	6SE0170-2CH41-2 ■ A7	O
2T6F-77602-913	1597	1430	1700	1300	6SE0170-2CH41-3 ■ A7	O
2T6F-77602-915	1781	1600	1870	1500	6SE0170-2CH41-5 ■ A7	O
2T6F-77602-917	2010	1810	2020	1700	6SE0170-2CH41-7 ■ A7	O
2T6F-77602-919	2194	1980	2150	1900	6SE0170-2CH42-0 ■ A7	O
2T6F-77603-920	2369	2140	2540	2000	6SE0170-2DH42-2 ■ A7	O
2T6F-77603-923	2648	2400	2800	2300	6SE0170-2DH42-4 ■ A7	O
2T6F-77603-926	2983	2710	3030	2600	6SE0170-2DH42-7 ■ A7	O
2T6F-77603-929	3272	2970	3230	2900	6SE0170-2DH43-0 ■ A7	O
2T6F-77604-931	3516	3200	3730	3100	6SE0170-2EH43-2 ■ A7	O
2T6F-77604-935	3956	3610	4030	3500	6SE0170-2EH43-6 ■ A7	O
2T6F-77604-939	4336	3960	4300	3900	6SE0170-2EH44-0 ■ A7	O

See article number code on Page 3/48.

Notice:

The 690 V, 12-pulse, liquid-cooled version of the SINAMICS G180 cabinet unit is normally operated on a three-winding transformer. This transformer can be ordered as a separate item on request. This version of the cabinet unit could also operate on a shift transformer.

Please ask your Siemens contact person for further advice.

690 V, 18-pulse

SINAMICS G180 cabinet unit (3 × 400 to 600/690 V 3 AC IT system, 50 to 60 Hz)¹⁾

Converter type	Connected load kVA	Output		Type rating ³⁾ kW	SINAMICS G180 cabinet units, liquid-cooled Article No.	Version (for option selection)
		Continuous current A	Short-time current ²⁾ A			
2T6K-77603-920	2369	2140	2540	2000	6SE0170-3DH42-2 ■ A7	O
2T6K-77603-923	2648	2400	2800	2300	6SE0170-3DH42-4 ■ A7	O
2T6K-77603-926	2983	2710	3030	2600	6SE0170-3DH42-7 ■ A7	O
2T6K-77603-929	3272	2970	3230	2900	6SE0170-3DH43-0 ■ A7	O
2T6K-77606-941	4692	4290	5100	4100	6SE0170-3HH44-3 ■ A7	O
2T6K-77606-947	5244	4800	5610	4700	6SE0170-3HH44-8 ■ A7	O
2T6K-77606-953	5916	5420	6040	5300	6SE0170-3HH45-4 ■ A7	O
2T6K-77606-958	6482	5940	6450	5800	6SE0170-3HH46-0 ■ A7	O

See article number code on Page 3/48.

¹⁾ With an NRTL unit ("U" in 14th position of article number), the voltage range ends at maximum 600 V, otherwise at 690 V. ³⁾ Rated power of a typical 2- to 6-pole standard motor.

²⁾ Short-time current for 60 s every 10 minutes.

SINAMICS G180

SINAMICS G180 cabinet units

SINAMICS G180 cabinet units liquid-cooled

Selection and ordering data (continued)

690 V, 24-pulse

SINAMICS G180 cabinet unit (4 × 400 to 600/690 V 3 AC IT system, 50 to 60 Hz)¹⁾

Converter type	Connected load kVA	Output		Type rating ³⁾ kW	SINAMICS G180 cabinet units, liquid-cooled Article No.	Version (for option selection)
		Continuous current A	Short-time current ²⁾ A			
2T6L-77602-912	1405	1260	1520	1200	6SE0170-4CH41-2 ■ A7	O
2T6L-77602-913	1597	1430	1700	1300	6SE0170-4CH41-3 ■ A7	O
2T6L-77602-915	1781	1600	1870	1500	6SE0170-4CH41-5 ■ A7	O
2T6L-77602-917	2010	1810	2020	1700	6SE0170-4CH41-7 ■ A7	O
2T6L-77602-919	2194	1980	2150	1900	6SE0170-4CH42-0 ■ A7	O
2T6L-77604-931	3516	3200	3730	3100	6SE0170-4EH43-2 ■ A7	O
2T6L-77604-935	3956	3610	4030	3500	6SE0170-4EH43-6 ■ A7	O
2T6L-77604-939	4336	3960	4300	3900	6SE0170-4EH44-0 ■ A7	O
2T6L-77606-941	4692	4290	5100	4100	6SE0170-4HH44-3 ■ A7	O
2T6L-77606-947	5244	4800	5610	4700	6SE0170-4HH44-8 ■ A7	O
2T6L-77606-953	5916	5420	6040	5300	6SE0170-4HH45-4 ■ A7	O
2T6L-77606-958	6482	5940	6450	5800	6SE0170-4HH46-0 ■ A7	O

See article number code on Page 3/48.

¹⁾ With an NRTL unit ("U" in 14th position of article number), the voltage range ends at maximum 600 V, otherwise at 690 V.

²⁾ Short-time current for 60 s every 10 minutes.

³⁾ Rated power of a typical 2- to 6-pole standard motor.

Dimensional drawings

Frame size SW2

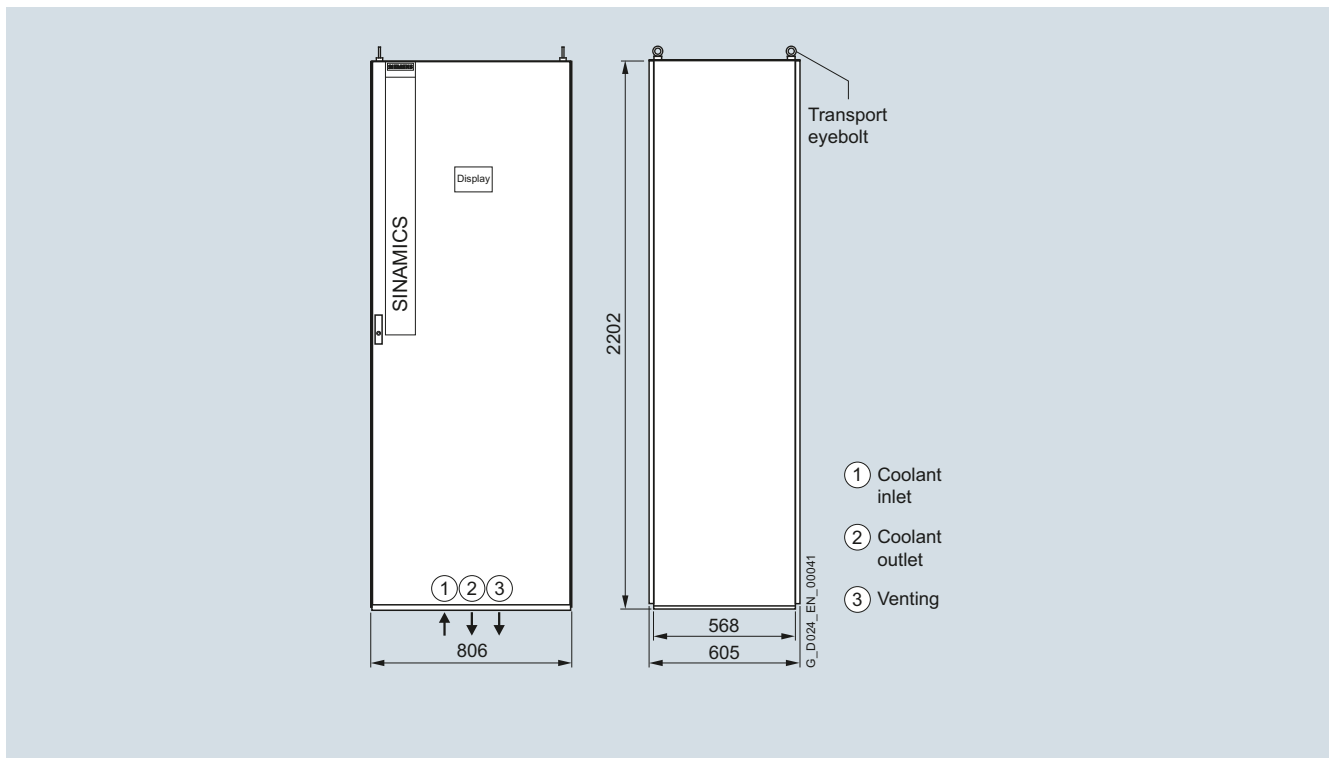

Dimensional drawing applies to standard converters without options. The cabinet dimensions might change if options are selected.

SINAMICS G180 cabinet units, liquid-cooled	Converter type
6SE0170-1BA33-7A7	2T6A-77401-200
6SE0170-1BA34-6A7	2T6A-77401-250
6SE0170-1BA36-3A7	2T6A-77401-315
6SE0170-1BD33-7A7	2T6A-77501-250
6SE0170-1BD34-6A7	2T6A-77501-315
6SE0170-1BD36-0A7	2T6A-77501-400
6SE0170-1B33-2A7	2T6A-77601-250
6SE0170-1B33-6A7	2T6A-77601-315
6SE0170-1B34-2A7	2T6A-77601-400

SINAMICS G180

SINAMICS G180 cabinet units

SINAMICS G180 cabinet units
liquid-cooled

Dimensional drawings (continued)

Frame size SW21

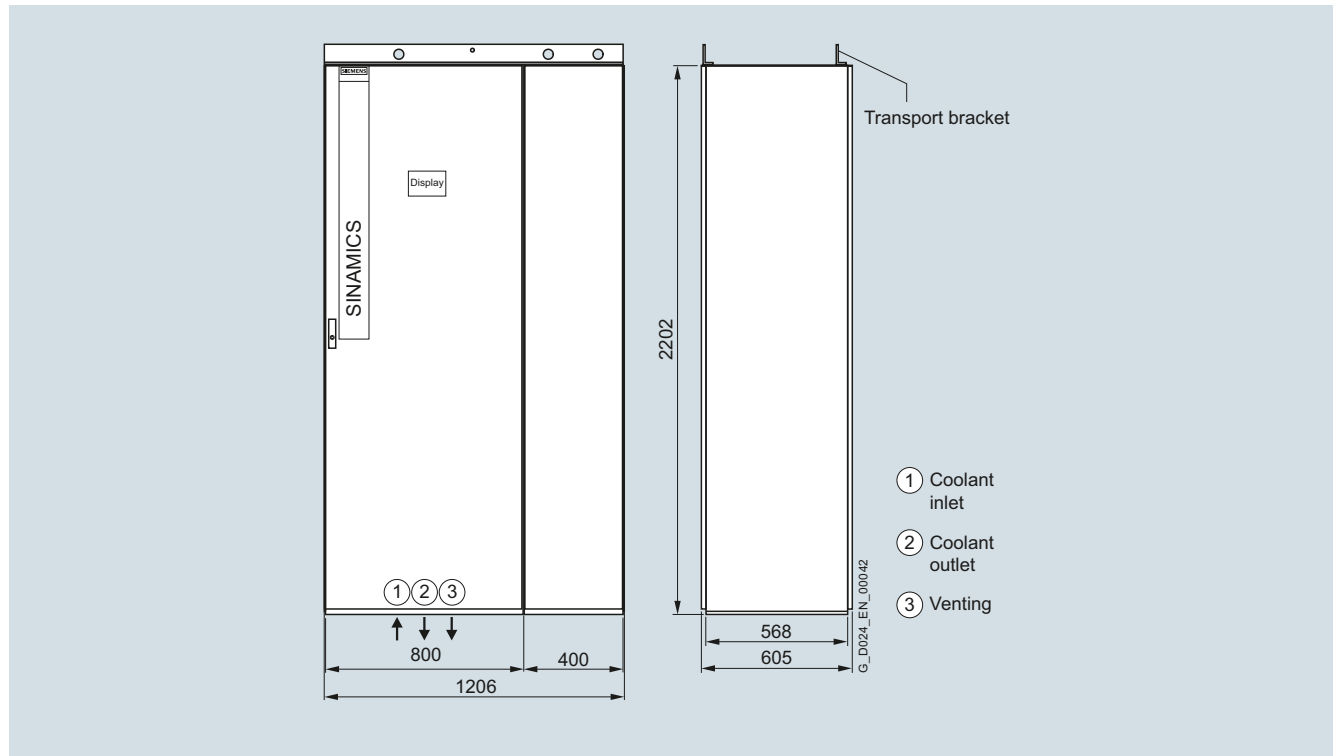

Dimensional drawing applies to standard converters without options. The cabinet dimensions might change if options are selected.

SINAMICS G180 cabinet units, liquid-cooled	Converter type
6SE0170-1BA37-3A7	2T6A-77401-400
6SE0170-1BD37-3A7	2T6A-77501-500
6SE0170-1B35-2A7	2T6A-77601-500

Dimensional drawings (continued)

Frame size SW3

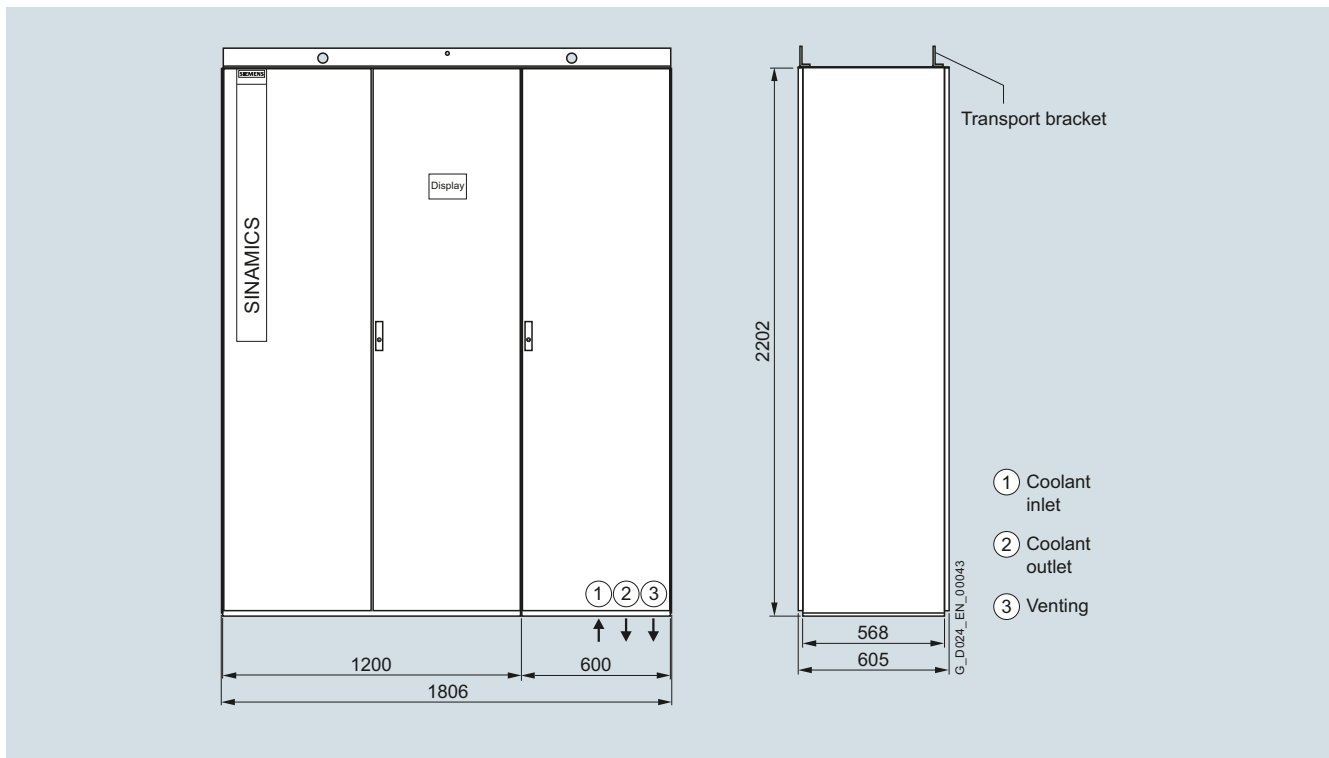

Dimensional drawing applies to standard converters without options. The cabinet dimensions might change if options are selected.

SINAMICS G180 cabinet units, liquid-cooled	<i>Converter type</i>
6SE0170-1BA38-8■A7	2T6A-77401-500
6SE0170-1BA41-0■A7	2T6A-77401-560
6SE0170-1BA41-1■A7	2T6A-77401-630
6SE0170-1BD38-2■A7	2T6A-77501-560
6SE0170-1BD38-8■A7	2T6A-77501-630
6SE0170-1BD41-0■A7	2T6A-77501-710
6SE0170-1BD41-1■A7	2T6A-77501-800
6SE0170-1B■35-7■A7	2T6A-77601-560
6SE0170-1B■36-4■A7	2T6A-77601-630
6SE0170-1B■37-1■A7	2T6A-77601-710
6SE0170-1B■37-7■A7	2T6A-77601-800
6SE0170-1B■41-0■A7	2T6A-77601-909
6SE0170-1B■41-1■A7	2T6A-77601-910

SINAMICS G180

SINAMICS G180 cabinet units

SINAMICS G180 cabinet units
liquid-cooled

Dimensional drawings (continued)

Frame size SW4

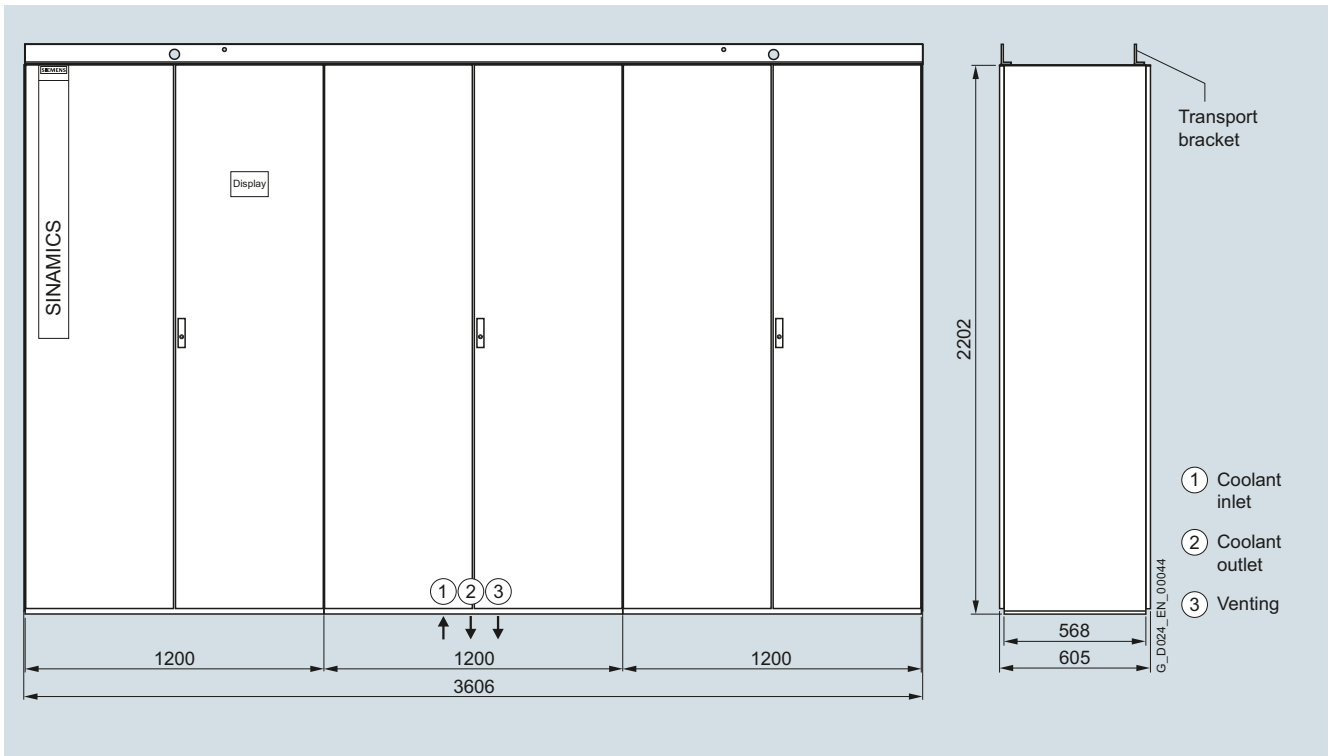

Dimensional drawing applies to standard converters without options. The cabinet dimensions might change if options are selected.

SINAMICS G180 cabinet units, liquid-cooled	Converter type
6SE0170-1C41-2A7	2T6A-77602-912
6SE0170-1C41-3A7	2T6A-77602-913
6SE0170-1C41-5A7	2T6A-77602-915
6SE0170-1C41-7A7	2T6A-77602-917
6SE0170-1C42-0A7	2T6A-77602-919
6SE0170-2CH41-2A7	2T6F-77602-912
6SE0170-2CH41-3A7	2T6F-77602-913
6SE0170-2CH41-5A7	2T6F-77602-915
6SE0170-2CH41-7A7	2T6F-77602-917
6SE0170-2CH42-0A7	2T6F-77602-919

Dimensional drawings (continued)

Frame size SW5

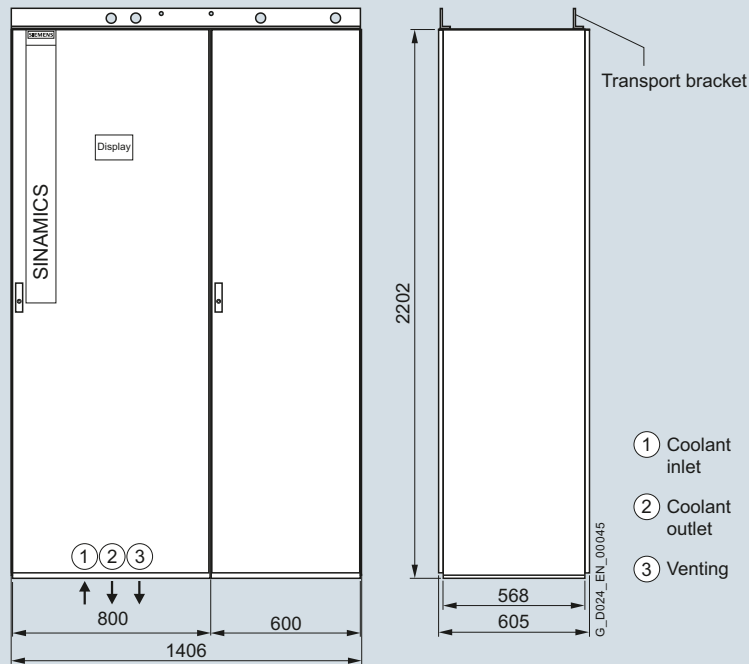

Dimensional drawing applies to standard converters without options. The cabinet dimensions might change if options are selected.

SINAMICS G180 cabinet units, liquid-cooled	<i>Converter type</i>
6SE0170-2BA33-7■A7	2T6F-77401-200
6SE0170-2BA34-6■A7	2T6F-77401-250
6SE0170-2BA36-3■A7	2T6F-77401-315
6SE0170-2BA37-3■A7	2T6F-77401-400
6SE0170-2BD33-7■A7	2T6F-77501-250
6SE0170-2BD34-6■A7	2T6F-77501-315
6SE0170-2BD36-3■A7	2T6F-77501-400
6SE0170-2BD37-3■A7	2T6F-77501-500
6SE0170-2BH33-2■A7	2T6F-77601-250
6SE0170-2BH33-6■A7	2T6F-77601-315
6SE0170-2BH34-2■A7	2T6F-77601-400
6SE0170-2BH35-2■A7	2T6F-77601-500

SINAMICS G180

SINAMICS G180 cabinet units

SINAMICS G180 cabinet units
liquid-cooled

Dimensional drawings (continued)

Frame size SW6

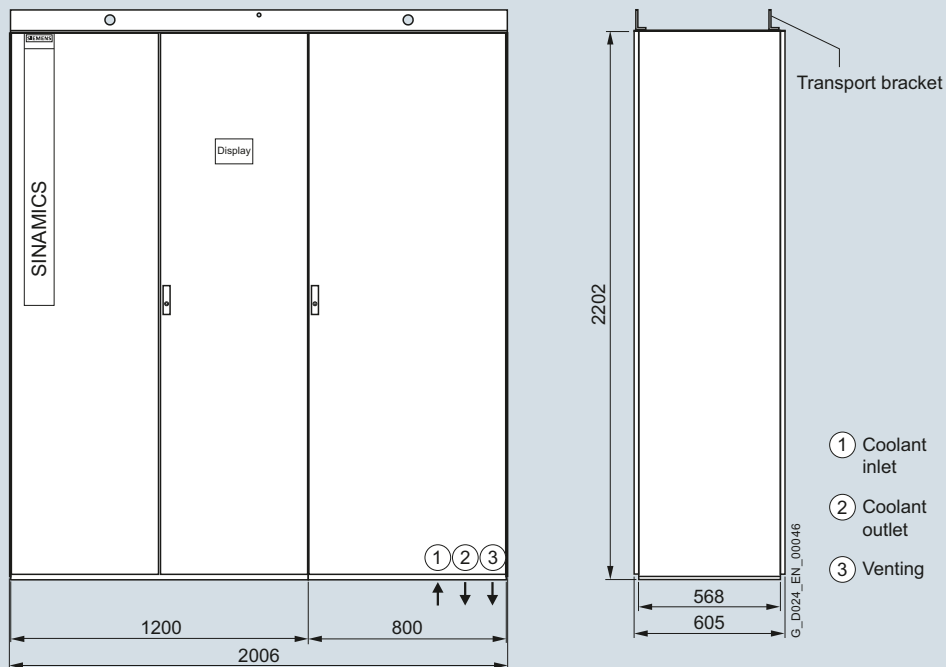

Dimensional drawing applies to standard converters without options. The cabinet dimensions might change if options are selected.

SINAMICS G180 cabinet units, liquid-cooled	Converter type
6SE0170-2BA38-8■A7	2T6F-77401-500
6SE0170-2BA41-0■A7	2T6F-77401-560
6SE0170-2BA41-1■A7	2T6F-77401-630
6SE0170-2BD38-2■A7	2T6F-77501-560
6SE0170-2BD38-8■A7	2T6F-77501-630
6SE0170-2BD41-0■A7	2T6F-77501-710
6SE0170-2BD41-1■A7	2T6F-77501-800
6SE0170-2BH35-7■A7	2T6F-77601-560
6SE0170-2BH36-4■A7	2T6F-77601-630
6SE0170-2BH37-1■A7	2T6F-77601-710
6SE0170-2BH37-7■A7	2T6F-77601-800
6SE0170-2BH41-0■A7	2T6F-77601-909
6SE0170-2BH41-1■A7	2T6F-77601-910

Dimensional drawings (continued)

Frame size SW7

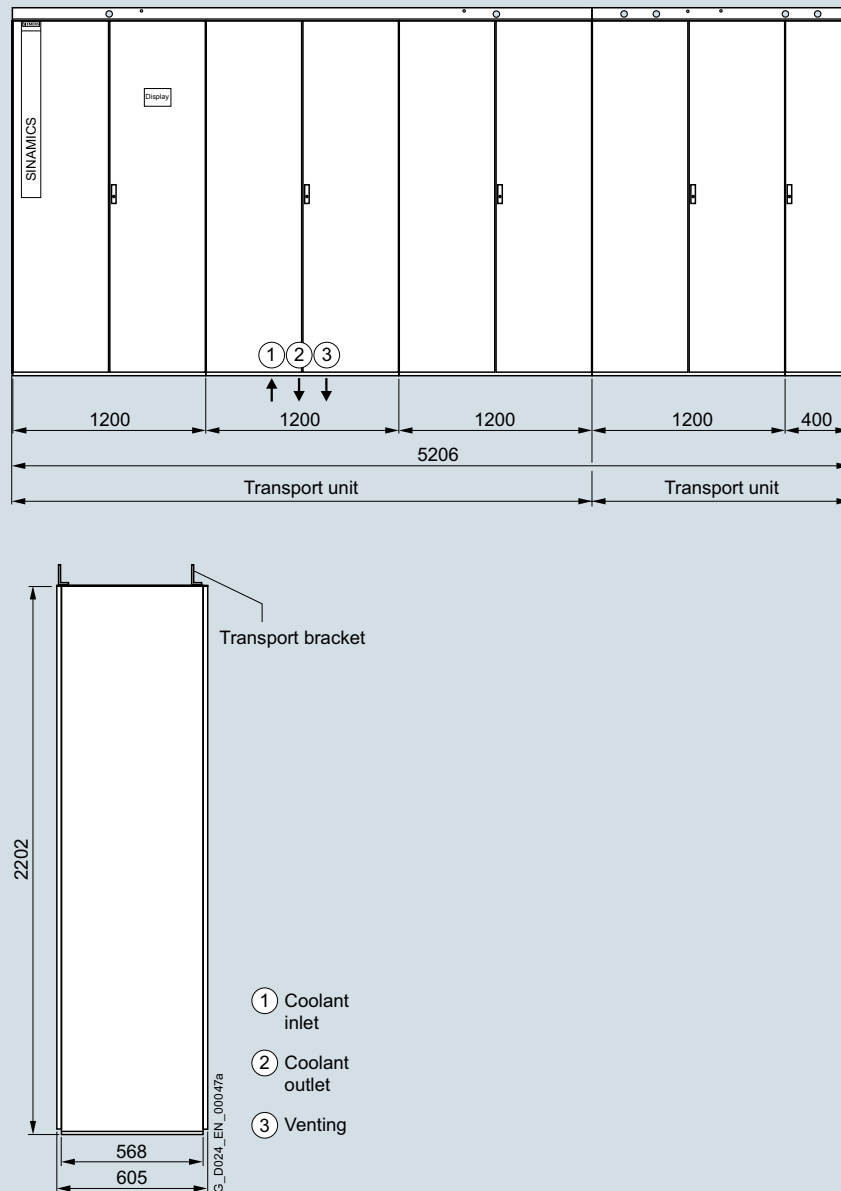

Dimensional drawing applies to standard converters without options. The cabinet dimensions might change if options are selected.

SINAMICS G180 cabinet units, liquid-cooled	Converter type
6SE0170-2DH42-2■A7	2T6F-77603-920
6SE0170-2DH42-4■A7	2T6F-77603-923
6SE0170-2DH42-7■A7	2T6F-77603-926
6SE0170-2DH43-0■A7	2T6F-77603-929
6SE0170-3DH42-2■A7	2T6K-77603-920
6SE0170-3DH42-4■A7	2T6K-77603-923
6SE0170-3DH42-7■A7	2T6K-77603-926
6SE0170-3DH43-0■A7	2T6K-77603-929

SINAMICS G180

SINAMICS G180 cabinet units

SINAMICS G180 cabinet units
liquid-cooled

Dimensional drawings (continued)

Frame size SW8

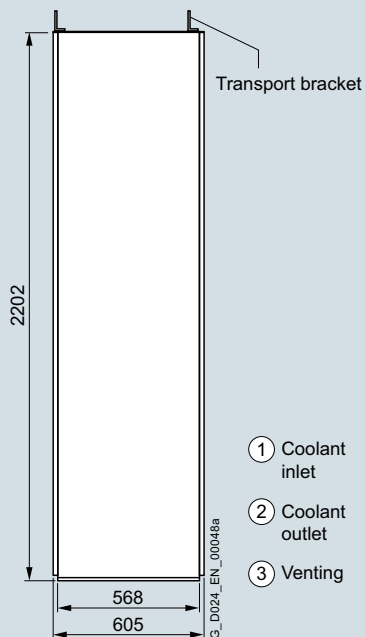
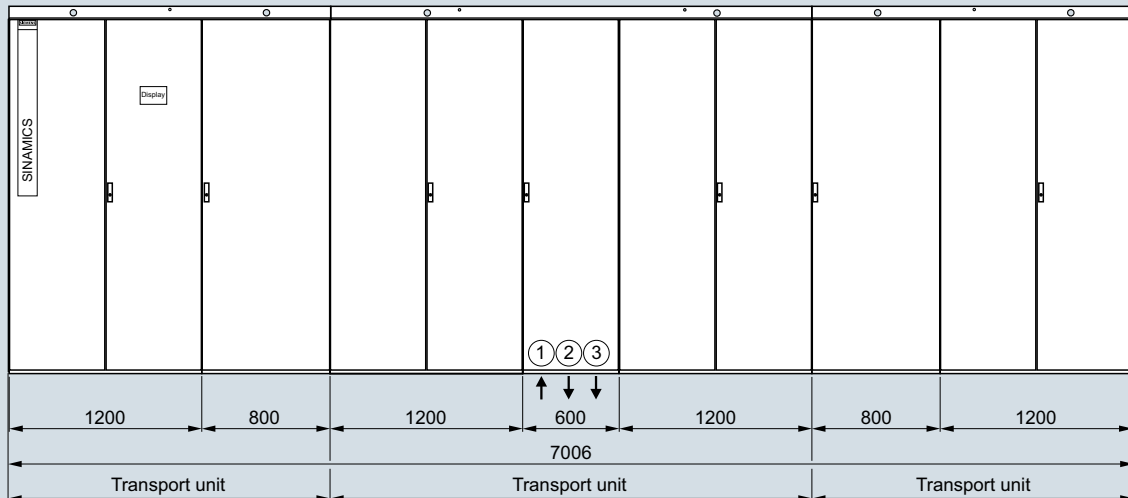

- ① Coolant inlet
- ② Coolant outlet
- ③ Venting

Dimensional drawing applies to standard converters without options. The cabinet dimensions might change if options are selected.

SINAMICS G180 cabinet units, liquid-cooled	Converter type
6SE0170-2EH43-2■A7	2T6F-77604-931
6SE0170-2EH43-6■A7	2T6F-77604-935
6SE0170-2EH44-0■A7	2T6F-77604-939

Dimensional drawings (continued)

Frame size SW9

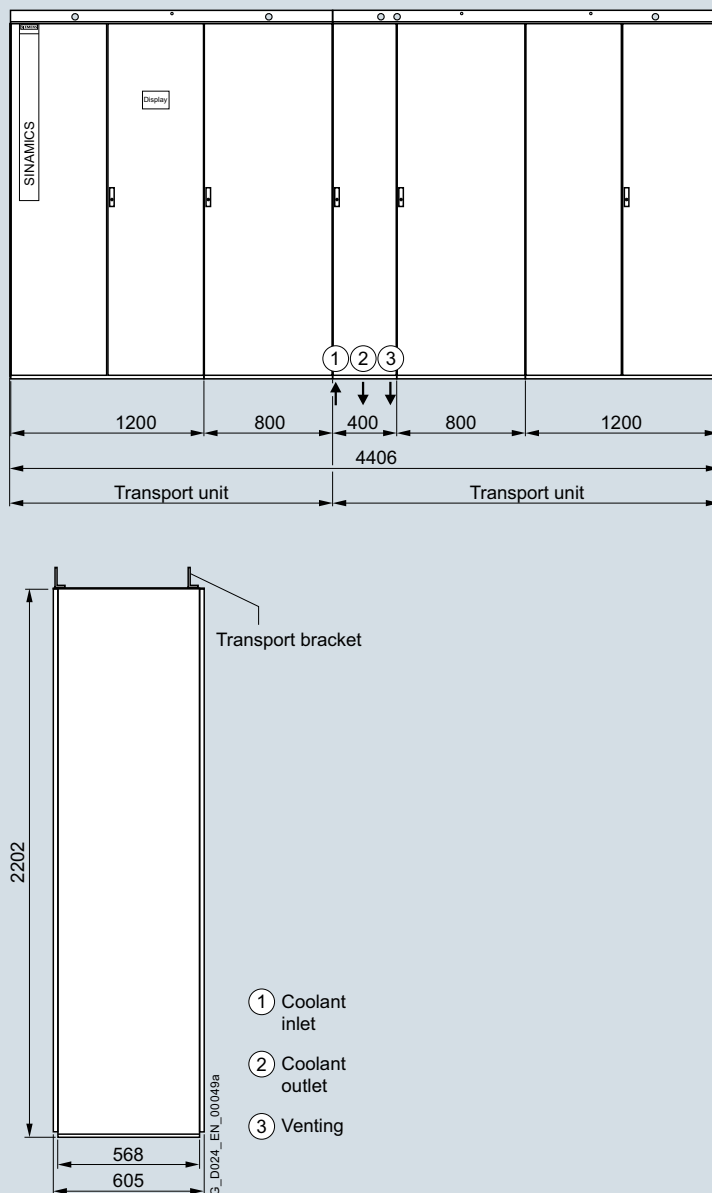

Dimensional drawing applies to standard converters without options. The cabinet dimensions might change if options are selected.

SINAMICS G180 cabinet units, liquid-cooled	Converter type
6SE0170-4CH41-2■A7	2T6L-77602-912
6SE0170-4CH41-3■A7	2T6L-77602-913
6SE0170-4CH41-5■A7	2T6L-77602-915
6SE0170-4CH41-7■A7	2T6L-77602-917
6SE0170-4CH42-0■A7	2T6L-77602-919

SINAMICS G180

SINAMICS G180 cabinet units

SINAMICS G180 cabinet units liquid-cooled

Dimensional drawings (continued)

Frame size SW10

3

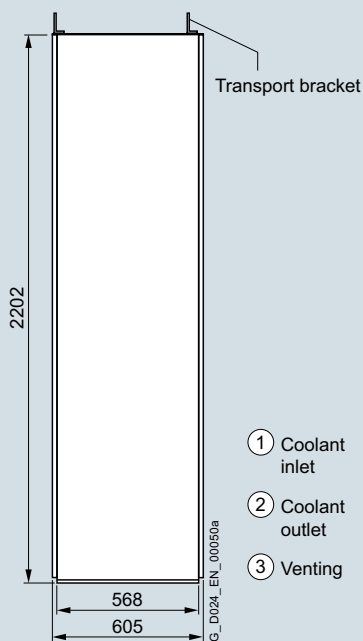
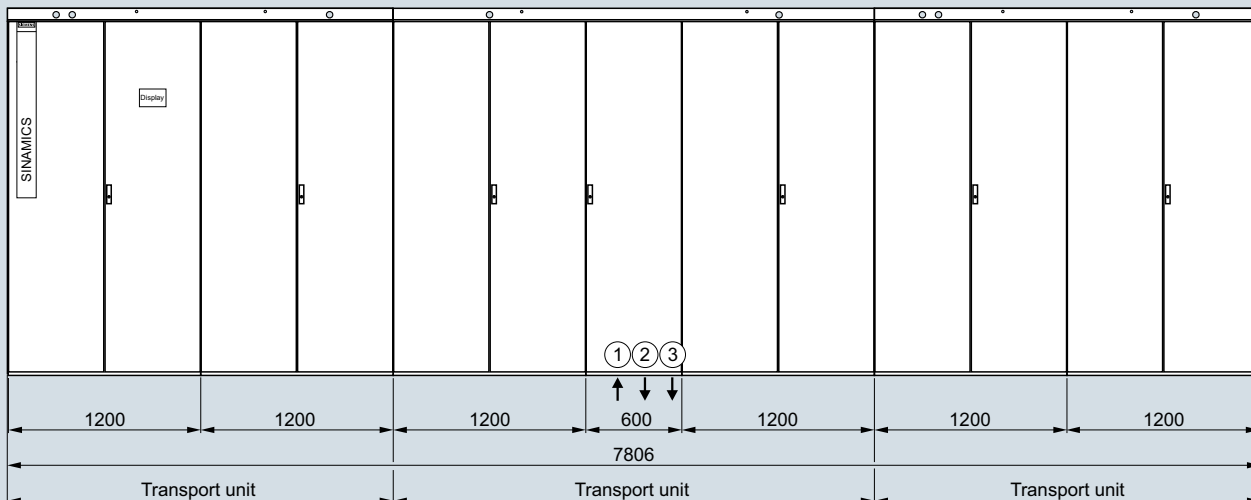

Dimensional drawing applies to standard converters without options. The cabinet dimensions might change if options are selected.

SINAMICS G180 cabinet units, liquid-cooled	Converter type
6SE0170-4EH43-2■A7	2T6L-77604-931
6SE0170-4EH43-6■A7	2T6L-77604-935
6SE0170-4EH44-0■A7	2T6L-77604-939

Option descriptions

4/2 **Standard options**4/2 **B48**

Test sequence schedule

4/2 **B38**

Spare parts price list

4/2 **B43 and B45**

Production flowchart

4/2 **C36, C38, C43, C48 and Y36**

External auxiliary power supply

4/2 **C56, C57 and Y55**

External control voltage supply

4/3 **D01, D02, D04, D05 and D06**

Converter documentation

4/3 **G13, G14, G15, G16 and G18**Accessories for IMS
(Inverter Management Software)4/4 **M96, M93 and M94**Marking of cable cores and
items of equipment4/5 **E85** Board for mains supply backup4/5 **G01, G12, G20, G22 and G27**

Additional boards for bus connection

4/7 **G02, G03, G04 and G05**

Peripheral boards 1 to 4

4/13 **G10, G11, K14, K15 and K37**Control elements and display
instruments in control cabinet door4/15 **L00 and L02** RFI suppression filter4/15 **L03 and L04** Line Harmonics Filter4/16 **L10, L14, L15, L16 and L17**

Output filter

4/17 **L48, L49, L50, L55, N35, N36, Y11
and Y98**

Accessories

4/19 **L72**

Braking chopper

4/19 **L80, L81, L82, L83 and Y80**

CALOMAT CK145

4/20 **L87**

Insulation monitoring

4/21 **L90, L91, L92, L93, L94, Y90
and Y94**

Pt100 evaluation unit

4/23 **M05, M06, M07, M13, M17, M19,
M24, M28, M34, M38, M39, M40,
M59, M78, Y09 and Y19**

Cabinet options

4/26 **M21, M41, M43, M54, M55 and M63**

Degrees of protection

4/28 **M20 and N50**

Wiring options

4/28 **Q80, Q81, Q82, Q83, Q84 and Q85**

Extension of the liability for defects

4/29 **S01, S02, S08, S09, S11, S12, S21,
S22, S23, S24, S31, S41 and G08**

Standard accessories packages

4/30 **T01 and Y33**

Label for plant identification

4/30 **T23, T24, T25, T26, T58, T60, T74, T76,
T82, T85 and T86**Converter display language
(language 1/language 2)4/30 **U04**

Gost-R certificate

4/31 **H80, H81, H82, H83, H84, H85 and H86**Cabinet widths for cabinet systems
with compact units4/31 **H90, H91, H92, H93 and H94**

Additional cabinets for cabinet units

4/31 **V61, V62 and V63**Ambient temperature for
air-cooled converters4/31 **V66, V67 and V68**Water inlet temperature for
liquid-cooled converters4/31 **V86, V87, V88 and V89**

Installation altitude

4/31 **V70, V71, V72, V73, V74, V75, V76, V77,
V78, V79, V80 and Y70**

Line voltages

4/31 **Y13**

Language of manual

4/32 **Inspection options**4/32 **F71 to F73 and F80 to F85**

Inspections for converters

4/34 **Engineer To Order – ETO**

4/34 Engineering

SINAMICS G180

Option descriptions

Standard options

Options

B48 **Test sequence schedule**

Option **B48** provides an order-specific test sequence schedule. This will be sent by e-mail approximately 6 weeks following receipt of order in PDF format (English/German).

B38 **Spare parts price list**

With option **B38**, a spare parts price list will be supplied for the converter. This list contains the recommended spare parts for commissioning, as well as for 5-year operation.

B43 and B45 **Production flowchart**

Inadmissible option combinations **B43** and **B45**

Documentation, production flowcharts		B43	B45
Generated once	B43		–
Updated every month	B45	–	

– Options mutually exclude each other.

Options **B43** and **B45** provide production flowcharts. These will be sent by e-mail following receipt of order either in MPP format (Microsoft Project) or in PDF format (English/German) as required. Please select format.

Option	Description
B43	Production flowchart: Generated once
B45	Production flowchart: Updated every month

C36, C38, C43, C48 and Y36 **External auxiliary power supply**

With options **C36, C38, C43, C48** and **Y36**, a connection terminal is available to the customer that can be used to supply loads (cabinet fan, cabinet heater, cabinet lighting, PLC, etc.) from an external power source. The supply system type for options C36, C38, C43, and C48 is grounded (TN/TT system). Only one phase is protected using a suitable miniature circuit breaker. Different voltages and supply system types are defined using option Y36. Please specify additional protection or connection of the N conductor (prescribed in certain countries).

Auxiliary DC voltage on request.

Option	Description
C36	Connection of 230 V 1 AC 50 Hz auxiliary voltage provided by the customer The maximum current consumption is 4 A
C38	Connection of 400 V 3 AC 50 Hz auxiliary voltage provided by the customer The maximum current consumption is 4 A
C43	Connection of 500 V 3 AC 50 Hz auxiliary voltage provided by the customer The maximum current consumption is 4 A
C48	Connection of 690 V 3 AC 50 Hz auxiliary voltage provided by the customer The maximum current consumption is 4 A
Y36	Connection of different level of 3-phase AC voltage provided by the customer; please specify voltage The maximum current consumption is 4 A

C56, C57 and Y55 **External control voltage supply**

Inadmissible option combinations **C56, C57** and **Y55**

External control voltage supply		C56	C57	Y55
Connection of 230 V 1 AC 50 Hz control voltage provided by the customer, no UPS backup	C56		–	–
Connection of 230 V 1 AC 50 Hz control voltage provided by the customer; UPS backup	C57	–		–
Connection of different level of single-phase AC voltage provided by the customer; please specify voltage	Y55	–	–	

– Options mutually exclude each other.

With options **C56, C57** and **Y55**, an external current source is defined for the converter. This is necessary in the following situations:

- If the display should indicate correctly even though no line voltage is present and the converter should not indicate a fault.
- The initialization time for the converter of approximately 3 s for temporary power failures does not apply in the case of an external, backed-up control voltage (precharging and synchronization time, however, remain unaffected).

If no external control voltage supply is selected, the converter will be supplied from the DC link in the case of compact units without a main contactor. For the following compact units, an additional board is required for mains supply backup (option E85):

Type	Converter type
6SE0100-1A■23-4■A7	2T2A-07600-030
6SE0100-1A■24-2■A7	2T2A-07600-037
6SE0100-1A■25-0■A7	2T2A-07600-045
6SE0100-1A■25-8■A7	2T2A-07600-055
6SE0100-1A■28-0■A7	2T2A-07600-075
6SE0100-1A■31-0■A7	2T2A-07600-090
6SE0100-1A■31-2■A7	2T2A-07600-110
6SE0100-1A■31-4■A7	2T2A-07600-132
6SE0100-1A■31-7■A7	2T2A-07600-160
6SE0100-1A■32-1■A7	2T2A-07600-200

For cabinet units with and without input contactors and for cabinet systems with input contactors, the control voltage is generated from the converter line voltage by a control transformer.

Options (continued)

Advantage:

When the converter control voltage is supplied from the DC link, this provides a backup function for drives with a coupled rotating mass (e.g. fan drive). This means that the DC link of the converter is maintained for a short time in the case of a temporary voltage drop or power failure due to continued rotation of the rotating mass on the motor. The control voltage for the converter is backed-up until the DC link voltage fails due to standstill of the rotating mass, or until the parameter "t-restart" causes switch-off.

Option	Description
C56	Connection for 230 V 1 AC 50 Hz external control voltage provided by the customer, <u>no</u> UPS backup With option C56 the customer provides the control voltage (230 V 1 AC +15 % -20 %; 47 to 63 Hz) for the converter. The control voltage has <u>no</u> UPS backup. The maximum current consumption is 4 A.
C57	Connection for 230 V 1 AC 50 Hz external control voltage provided by the customer, <u>with</u> UPS backup With option C57 the customer provides the control voltage (230 V 1 AC +15 % -20 %; 47 to 63 Hz) for the converter. The control voltage has <u>with</u> UPS backup. The maximum current consumption is 4 A.
Y55	Connection for different level of single-phase AC control voltage with 47 to 63 Hz provided by the customer, please specify voltage With option Y55 the customer provides the control voltage for the converter. The maximum current consumption is 4 A.

D01, D02, D04, D05 and D06 Converter documentation

For the scope of the converter documentation, see the "Documentation" section under "Services and documentation". A CD comprising a manual and IMS is supplied with every converter.

Option	Description
D01	Manual and set of diagrams in PDF format per e-mail, German/English
D02	Manual in PDF format, set of diagrams in DXF format per e-mail, German/English
D04	Manual and set of diagrams, single hardcopy, German/English
D05	Manual and set of diagrams in PDF format on CD, German/English
D06	Manual in PDF format, set of diagrams in DWG format on CD, German/English

Note:

Please ask your Siemens sales partner if the documentation or set of diagrams are required in a different language.

G13, G14, G15, G16 and G18 Accessories for IMS (Inverter Management Software)

G13 USB PROFIBUS interface (supplied separately packed)



G13 Softing PROFIBUS (PROFIBUS interface)

Active single-channel USB high-speed interface for connecting a PC with IMS to a PROFIBUS network. The interface is suitable for control and visualization tasks as well as for parameterization and analysis applications via the IMS. All SINAMICS G180 converters in the PROFIBUS network can be addressed.

No additional power connection is required for this converter. The cable on the converter has a double PROFIBUS SUB-D 9-pin connection (socket/plug with end wiring) for connecting to PROFIBUS. As a result, a simple connection is possible directly on the SINAMICS G180 with PROFIBUS board (**G01**).

Note:

The installation notes in the help function of IMS must be observed.

G14 Ethernet-PROFIBUS gateway



G14 Softing FG-100PB

Gateway between host systems on Ethernet and the PROFIBUS bus system. Suitable for network configuration, device parameterization or acquisition of operating data. All SINAMICS G180 converters in the PROFIBUS system can be monitored and parameterized.

The Ethernet-PROFIBUS gateway can be installed in the converter cabinet or supplied separately packed. Please specify your requirements in the order. The gateway is normally installed at the most favorable transition point between Ethernet and PROFIBUS.

Technical data:

- Dimensions (W × H × D) 47 × 131 × 11 mm
- Mounting on 35 mm DIN rail
- Power supply 24 V DC (±20 %); 0.3 A
- Operating temperature 0 °C to 55 °C

Scope of supply:

- Ethernet interface on PROFIBUS
- Installation manual
- CD with Windows drivers

Note:

The installation notes in the help function of IMS must be observed.

If the Ethernet-PROFIBUS gateway is supplied separately with the converter, a separately power supply unit is required. This is not part of the scope of supply.

SINAMICS G180

Option descriptions

Standard options

Options (continued)

G15 Ethernet to RS232/485/422 converter (supplied separately packed)

With option **G15** a serial/Ethernet converter is supplied separately packed. If several converters are interconnected over an RS485 network, up to 128 converters can be connected to Ethernet using one converter.

Technical data:

- Dimensions (W × H × D) 151 × 75 × 26 mm
- Power supply 10 to 30 V DC; 1.6 W

Note:

The installation notes in the help function of IMS must be observed.

An external power supply unit is required for the Ethernet to RS232/485/422 converter which is not part of the scope of supply.

G16 USB cable A/B, 2 m (supplied separately packed)



G16 USB cable A/B (example shown)

Option **G16** comprises a 2 m long USB cable for parameterizing the SINAMICS G180 from the IMS.

G18 USB connector on front of control cabinet door



G18 USB connector on front of control cabinet door (example shown)

With option **G18** a USB connector is installed in the control cabinet door that allows the converter to be parameterized from the IMS without having to open the cabinet door. IP65 degree of protection.

M96, M93 and M94

Marking of cable cores and items of equipment

Inadmissible option combinations **M93** and **M94**

Marking of cable cores and items of equipment		M96	M93	M94
Dual marking of items of equipment	M96		✓	✓
Cable marking, C-type	M93	✓		–
Cable marking (shrink-on sleeve)	M94	✓	–	

✓ Options are combinable.

– Options mutually exclude each other.

M96 Dual marking of items of equipment



M96 Example of dual marking of items of equipment

With option **M96** the items of equipment are marked twice, once on the equipment and once directly adjacent to the mounting location of the equipment.

M93 Cable marking, C-type

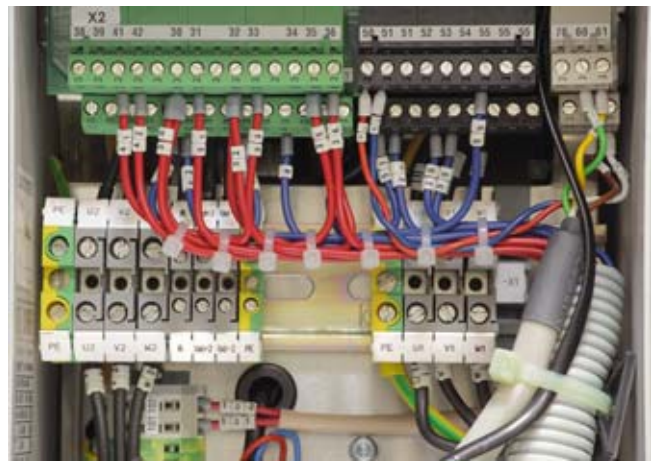

M93 Example of cable marking, C-type

- Cable markings in the shape of the letter C are clipped onto the control cables.
- Larger power cables are labeled using shrink-on sleeves.
- The terminal designation only is numbered on the cable and not the item designation.

Example:

Terminal –X2:41 → Cable is marked with 41.

Options (continued)

M94 Cable marking (shrink-on sleeve)**M94** Example of cable marking

- Cable markings using shrink-on sleeves are attached to the cables.
- The terminal designation and the item designation are labeled on the cable.

Example:

Terminal -X2:41 → Cable is marked with -X2:41.

E85**Board for mains supply backup**

To enable the control voltage to be generated from the DC link for the following converter types, option **E85** (series-connected power supply unit for mains supply backup) is required.

This option must be ordered separately for all cabinet units and for the following compact units:

Type	Converter type
6SE0100-1A-23-4-A7	2T2A-07600-030
6SE0100-1A-24-2-A7	2T2A-07600-037
6SE0100-1A-25-0-A7	2T2A-07600-045
6SE0100-1A-25-8-A7	2T2A-07600-055
6SE0100-1A-28-0-A7	2T2A-07600-075
6SE0100-1A-31-0-A7	2T2A-07600-090
6SE0100-1A-31-2-A7	2T2A-07600-110
6SE0100-1A-31-4-A7	2T2A-07600-132
6SE0100-1A-31-7-A7	2T2A-07600-160
6SE0100-1A-32-1-A7	2T2A-07600-200

Advantage:

When the converter control voltage is supplied from the DC link, this provides a backup function for drives with a coupled rotating mass (e.g. fan drive). This means that the DC link of the converter is maintained for a short time in the case of a temporary voltage drop or power failure due to continued rotation of the rotating mass on the motor. The control voltage for the converter is therefore backed up for a short time.

G01, G12, G20, G22 and G27**Additional boards for bus connection**Inadmissible option combinations **G01, G20, G22, G27**

Additional boards for bus connection		G01	G12	G20	G22	G27
Board for PROFIBUS DPV1	G01		✓	–	–	–
PROFIBUS expansion module for option G10 or G11	G12	✓		✓	✓	✓
Board for CANopen	G20	–	✓		–	–
Board for Modbus RTU	G22	–	✓	–		–
Board for Modbus TCP	G27	–	✓	–	–	

✓ Options are combinable.

– Options mutually exclude each other.

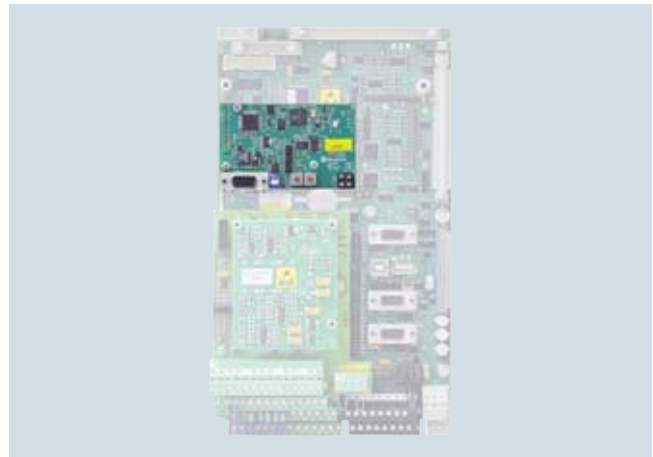
G01 Board for PROFIBUS DPV1**G01** PROFIBUS board for SINAMICS G180 in compact unit**G01** PROFIBUS board for SINAMICS G180 in cabinet unit

Option **G01** for the PROFIBUS DPV1 board is suitable for cyclic and non-cyclic data transfer and can be retrofitted in compact units and cabinet units at any time.

SINAMICS G180

Option descriptions

Standard options

Options (continued)

G12 PROFIBUS expansion module for option **G10** or **G11** (SENTRON PAC3200 power monitoring device)



G12 PROFIBUS expansion module

Option **G12** allows the SENTRON PAC3200 power monitoring device to be connected to PROFIBUS. This expansion module can only be ordered in conjunction with option **G10** or **G11**.

G20 Board for CANopen



G20 CANopen

Option **G20** (board for CANopen) transfers data in binary form. Fieldbus connection is implemented in accordance with the CANopen standard. This board can be retrofitted in compact units and cabinet units at any time, provided that no other bus system has been installed beforehand.

G22 Board for Modbus RTU

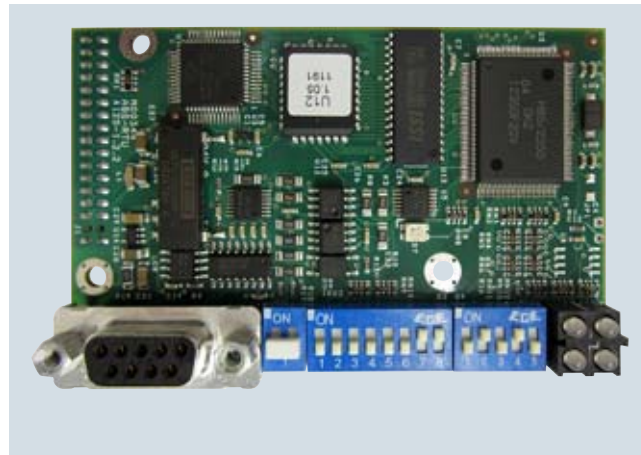

G22 Modbus RTU

Option **G22** (board for Modbus RTU) transfers data in binary form. This board can be retrofitted in compact units and cabinet units at any time, provided that no other bus system has been installed beforehand.

G27 Board for Modbus TCP

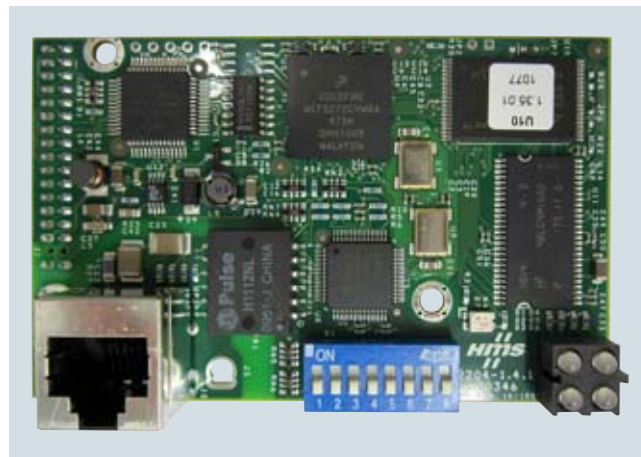

G27 Modbus TCP

Option **G27** (board for Modbus TCP) is very similar to Option **G22** (board for Modbus RTU), except that TCP packages are used to send the data. This board can be retrofitted in compact units and cabinet units at any time, provided that no other bus system has been installed beforehand.

Options (continued)

G02, G03, G04 and G05 Peripheral boards 1 to 4

Inadmissible option combinations
G02, G03, G04 and G05

Peripheral board 1 ... 4		G02	G03	G04	G05
Peripheral board 1	G02		–	–	–
Peripheral board 2	G03	–		–	–
Peripheral board 3	G04	–	–		–
Peripheral board 4	G05	–	–	–	

– Options mutually exclude each other.

The functionality of the converter is expanded with the peripheral board. Every converter can be fitted or even retrofitted with one of these peripheral boards.

Boards with safety-related inputs (PTC thermistor or the function "Safe Torque Off") are only permitted to be retrofitted by our authorized qualified personnel.

In addition to the main board, peripheral boards 2 and 4 are also expanded by a daughterboard which contains the circuitry for the PTC thermistor inputs.

	Peripheral board			
	1	2	3	4
2 PTC thermistor inputs for ATEX-certified motor temperature monitoring for motors in hazardous zones (prewarning/trip)		•		•
One input "Safe Torque Off" acc. to EN ISO 13849-1, Cat. 3. PL d or SIL 2 acc. to EN 61508			•	•
9 digital inputs (DI)			•	•
3 relay outputs (DO)			•	•
2 analog outputs (AO)	•	•	•	•
24 V / 300 mA power supply unit			•	•

G02 Peripheral board 1



G02 Peripheral board 1

Option **G02** (peripheral board 1) provides in addition to standard converter terminals:

- 2 analog outputs (AO)
4 to 20 mA/0 to 10 V

Standard assignment of inputs/outputs

The table below provides an overview of the pre-assignment function of interfaces in the pin assignments for the "Standard" application.

Signal designation	Function
Internal PTC thermistor input 90, 91, 92, 93	Not assigned
Internal analog output 64, 65	Torque
Internal analog output 66, 67	Power

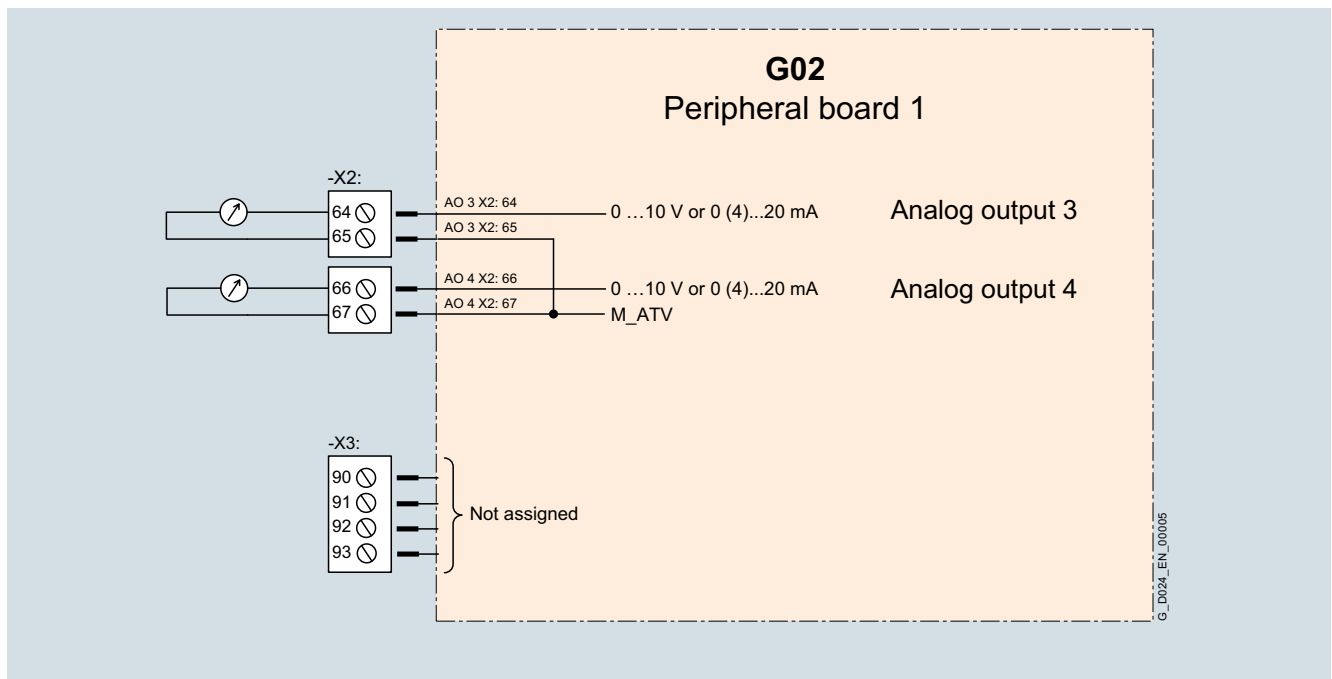

G02 Circuit diagram for peripheral board 1

SINAMICS G180

Option descriptions

Standard options

Options (continued)

G03 Peripheral board 2



G03 Peripheral board 2 in the compact unit

Option **G03** (peripheral board 2) provides in addition to standard converter terminals:

- 2 analog outputs (AO) 4 to 20 mA/0 to 10 V
- 2 PTC thermistor inputs for ATEX-certified motor temperature monitoring for motors in hazardous zones (prewarning/trip)
- PTC thermistor monitoring without contactor through monitoring unit integrated in converter, certified to SIL 1 in accordance with EN 61508

The converter controller processes the signal of the peripheral board. In the event of excessive motor temperature, or the function "Safe Torque Off", the converter inhibits the firing signals of the IGBTs. The voltage supply of the driver stages is also switched off. These two redundant, diverse and self-monitored switch-off paths ensure that the power infeed to the motor is safely interrupted. Further heating or rotation of the motor is excluded. The converter can only be reset or switched on when the motor has cooled down sufficiently and the fault has been acknowledged. When the voltage fails, the converter safely interrupts the power infeed to the motor, because firing signals are no longer transferred. If a fault was active at the moment of power failure, the converter will also be in fault status when power is restored.

Standard assignment of inputs/outputs

The table below provides an overview of the pre-assignment function of interfaces in the pin assignments for the "Standard" application.

Signal designation	Function
Internal PTC thermistor input 90, 91	PTC thermistor for disconnection (ATEX-certified)
Internal PTC thermistor input 92, 93	PTC thermistor for warning
Internal analog output 64, 65	Torque
Internal analog output 66, 67	Power

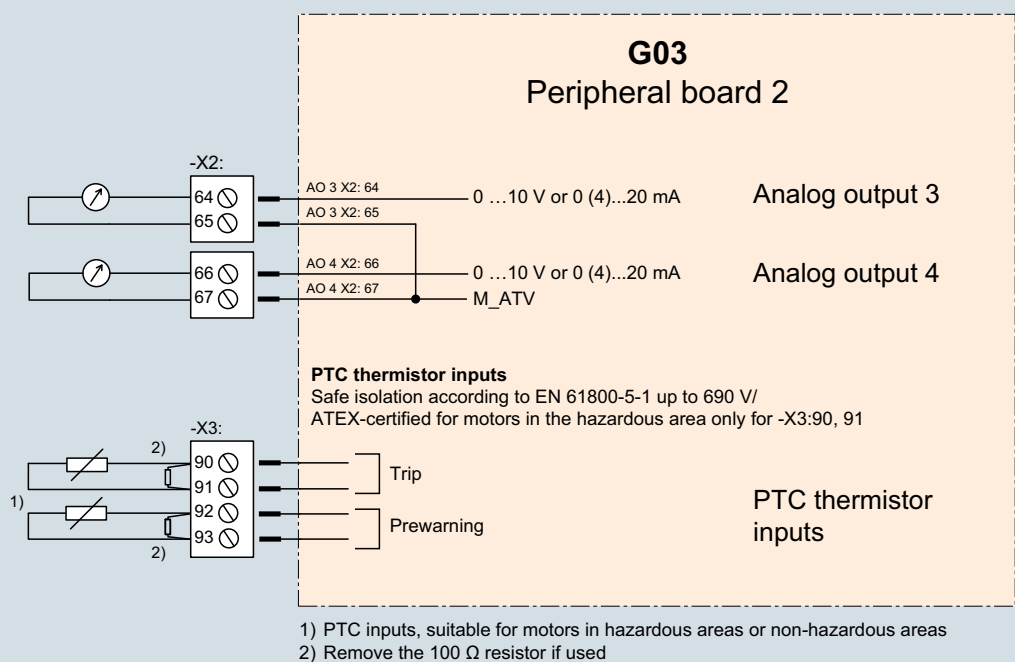

G03 Circuit diagram for peripheral board 2

Options (continued)

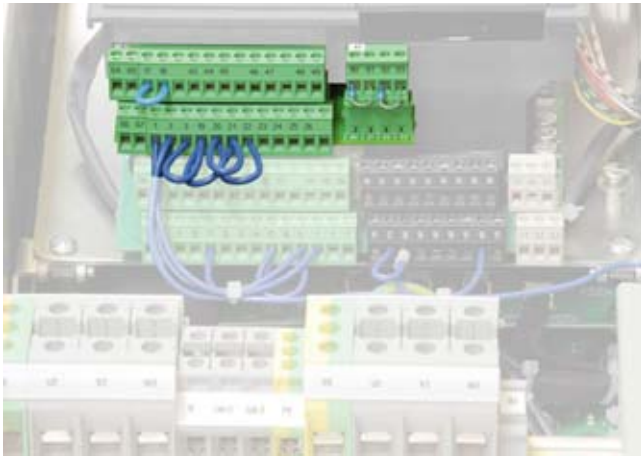
G04 Peripheral board 3**G04** Peripheral board 3 in the compact unit

Option **G04** (peripheral board 3) provides in addition to standard converter terminals:

- 2 analog outputs (AO) 4 to 20 mA/0 to 10 V
- One digital input "Safe Torque Off" (STO, single-channel or two-channel) acc. to EN ISO 13849-1, Cat. 3 or SIL 2 acc. to EN 61508
- 9 digital inputs (DI)
- 3 relay outputs (DO)
In addition, the relay outputs here are not only isolated from the converter electronics but also from each other.
- 24 V / 300 mA power supply unit

SIL 2 (acc. to EN 61508) – STO (Safe Torque Off).

Safe Torque Off (STO) function implemented according to SIL 2 to EN 61508.

The "Safe Torque Off" (STO) function has a redundant switch-off path in the converter. The implementation is performed using hardware. A relay in the power unit of the converter disconnects the power supply of the IGBT driver. A second circuit, also via hardware, produces a controller disable.

The "Safe Torque Off" input can be implemented with either one or two channels. The board is coded for single-channel activation at the factory. If two-channel activation is required, please specify this in the order. Digital input X2:24 is reserved for the two-channel version.

Standard assignment of inputs/outputs

The table below provides an overview of the pre-assignment function of interfaces in the pin assignments for the "Standard" application.

Signal designation	Function
Internal digital input 19, 20	24 V DC; "Safe Torque Off" acc. to EN ISO 13849-1, Cat. 3; or SIL 2 acc. to EN 61508
Internal digital input 6, 7, 21, 22, 23, 24, 25, 26	Freely parameterizable
Internal PTC thermistor input 90, 91, 92, 93	Not assigned
Internal digital output 43, 44, 45	Relay 5: "Motor temperature trip"
Internal digital output 46, 47	Relay 6: "Automatic mode (normal)"
Internal digital output 48, 49	Relay 7: "Speed 0"
Internal analog output 64, 65	Torque
Internal analog output 66, 67	Power

NAMUR-compliant assignment of inputs/outputs

The table below provides an overview of the pre-assignment function of interfaces in the pin assignments for the "NAMUR" application.

Signal designation	Function
Internal digital input 19, 20	+24 V DC; forced inverter inhibit
Internal digital input 6	Rapid stop global 1
Internal digital input 7	Separately driven fan of motor activated
Internal digital input 17, 18	Forced power supply disconnection
Internal digital input 21	External fault
Internal digital input 22	External warning
Internal digital input 23	Operation, bus
Internal digital input 24	Controller ON
Internal digital input 25	Fixed setpoint 1
Internal digital input 26	Fixed setpoint 2
Internal PTC thermistor input 90, 91, 92, 93	Not assigned
Internal digital output 43, 44, 45	Relay 5: "Motor temperature trip"
Internal digital output 46, 47	Relay 6: "Automatic mode (normal)"
Internal digital output 48, 49	Relay 7: "Speed 0"
Internal analog output 64, 65	Torque
Internal analog output 66, 67	Power

SINAMICS G180

Option descriptions

Standard options

Options (continued)

4

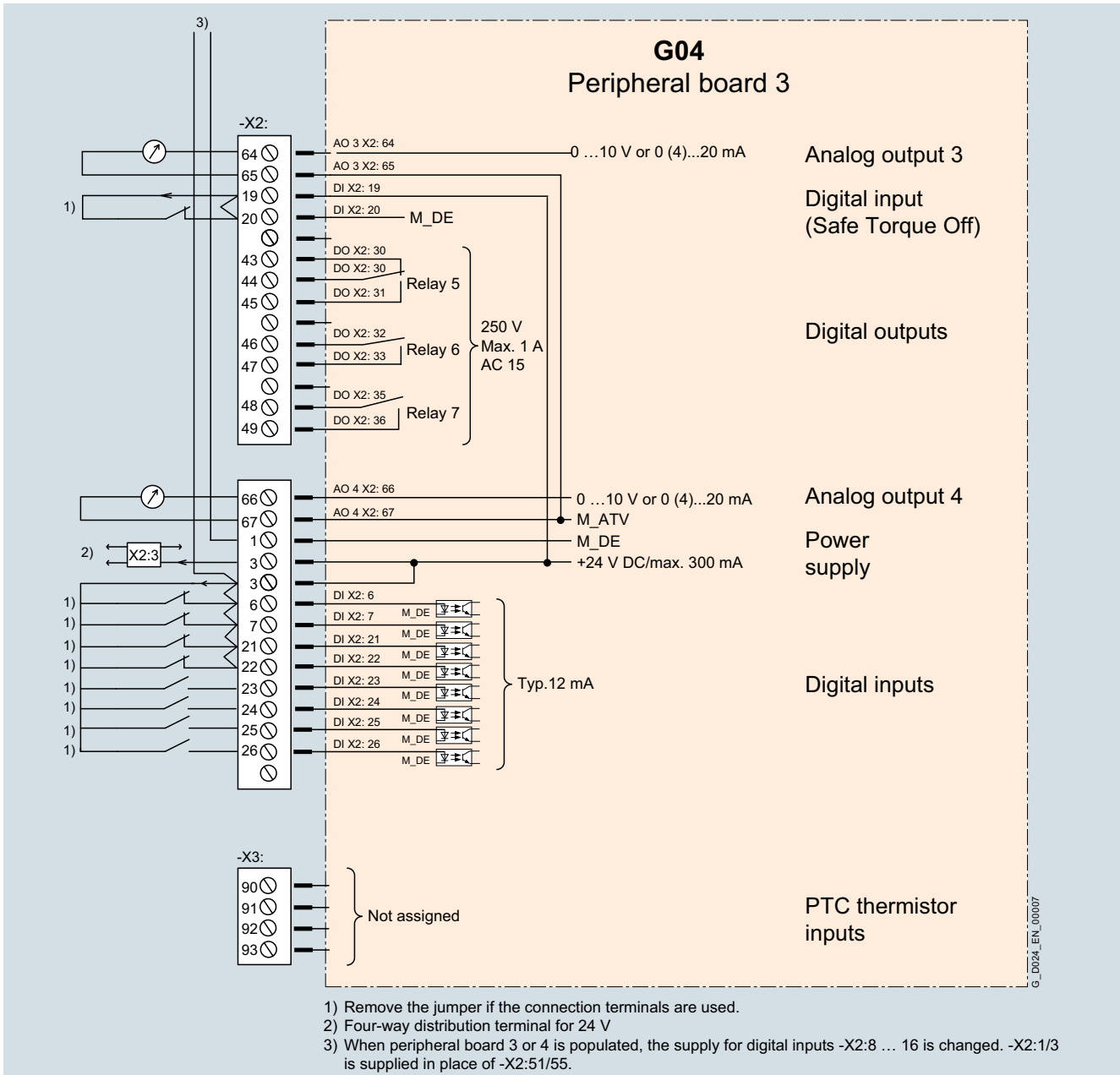

G04 Circuit diagram for peripheral board 3

Options (continued)

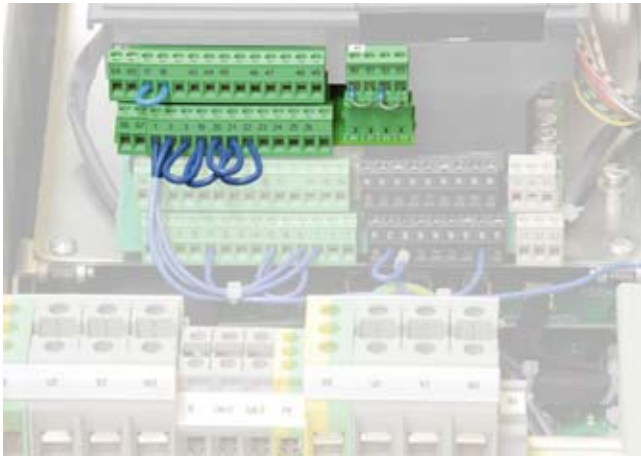
G05 Peripheral board 4**G05** Peripheral board 4 in the compact unit**G05** Peripheral board 4 in the cabinet unit

Option **G05** (peripheral board 4) provides in addition to the standard terminals:

- 2 analog outputs (AO) 4 to 20 mA/0 to 10 V
- 2 PTC thermistor inputs, one certified for ATEX (disconnection), one warning for motor temperature monitoring of motors in a hazardous area
- One digital input "Safe Torque Off" acc. to EN ISO 13849-1, Cat. 3/(STO) implemented according to SIL 2 acc. to EN 61508
9 digital inputs (DI)
- 3 relay outputs (DO)
In addition, the relay outputs here are not only isolated from the converter electronics but also from each other.
- 24 V / 300 mA power supply unit
- ATEX-certified PTC thermistor monitoring without contactor through monitoring unit integrated in converter, certified to SIL 1 in accordance with EN 61508

PTC thermistor monitoring without contactor through monitoring unit integrated in converter, certified to SIL 1 in accordance with EN 61508 or Category 2, PL c in accordance with EN ISO 13849-1

The converter controller processes the signal of the peripheral board. In the event of excessive motor temperature, or the function "Safe Torque Off", the converter inhibits the firing signals of the IGBTs. The voltage supply of the driver stages is also switched off. These two switch-off paths ensure that the power infeed to the motor is immediately interrupted. Further heating or rotation of the motor is excluded. The converter can only be reset or switched on when the motor has cooled down sufficiently. When the voltage fails, the converter safely interrupts the power infeed to the motor, because firing signals are no longer transferred. If a fault was active at the moment of power failure, the converter will also be in fault status when power is restored.

SIL 2 (acc. to EN 61508) – STO (Safe Torque Off).

Safe Torque Off (STO) function implemented according to SIL 2 to EN 61508.

The "Safe Torque Off" (STO) function has a redundant switch-off path in the converter. The implementation is performed using hardware. A relay in the power unit of the converter disconnects the power supply of the IGBT driver. A second circuit, also via hardware, produces a controller disable. Both switch-off paths are based on the closed-circuit principle, i.e. a failure of the control voltage results in shutdown of the converter.

The "Safe Torque Off" input can be implemented with either one or two channels. The board is coded for single-channel activation at the factory. If two-channel activation is required, please specify this in the order. Digital input X2:24 is reserved for the two-channel version.

Subsequent changeover from single-channel to two-channel is only permitted to be implemented by our authorized qualified personnel.

Standard assignment of inputs/outputs

The table below provides an overview of the pre-assignment function of interfaces in the pin assignments for the "Standard" application.

Signal designation	Function
Internal digital input 19, 20	24 V DC; "Safe Torque Off" acc. to EN ISO 13849-1, Cat. 3; or SIL 2 acc. to EN 61508
Internal digital input 6, 7, 21, 22, 23, 24, 25, 26	Freely parameterizable
Internal PTC thermistor input 90, 91	PTC thermistor for disconnection (ATEX-certified)
Internal PTC thermistor input 92, 93	PTC thermistor for warning
Internal digital output 43, 44, 45	Relay 5: "Motor temperature trip"
Internal digital output 46, 47	Relay 6: "Automatic mode (normal)"
Internal digital output 48, 49	Relay 7: "Speed 0"
Internal analog output 64, 65	Torque
Internal analog output 66, 67	Power

SINAMICS G180

Option descriptions

Standard options

Options (continued)

NAMUR-compliant assignment of inputs/outputs

The table below provides an overview of the pre-assignment function of interfaces in the pin assignments for the "NAMUR" application.

Signal designation	Function
Internal digital input 17, 18	Forced power supply disconnection
Internal digital input 19, 20	+24 V DC; forced inverter inhibit
Internal digital input 6	Rapid stop global 1
Internal digital input 7	Separately driven fan of motor activated
Internal digital input 21	External fault
Internal digital input 22	External warning
Internal digital input 23	Operation, bus

Signal designation	Function
Internal digital input 24	Controller ON
Internal digital input 25	Fixed setpoint 1
Internal digital input 26	Fixed setpoint 2
Internal PTC thermistor input 90, 91	PTC thermistor for disconnection (ATEX-certified)
Internal PTC thermistor input 92, 93	PTC thermistor for warning
Internal digital output 43, 44, 45	Relay 5: "Motor temperature trip"
Internal digital output 46, 47	Relay 6: "Automatic mode (normal)"
Internal digital output 48, 49	Relay 7: "Speed 0"
Internal analog output 64, 65	Torque
Internal analog output 66, 67	Power

4

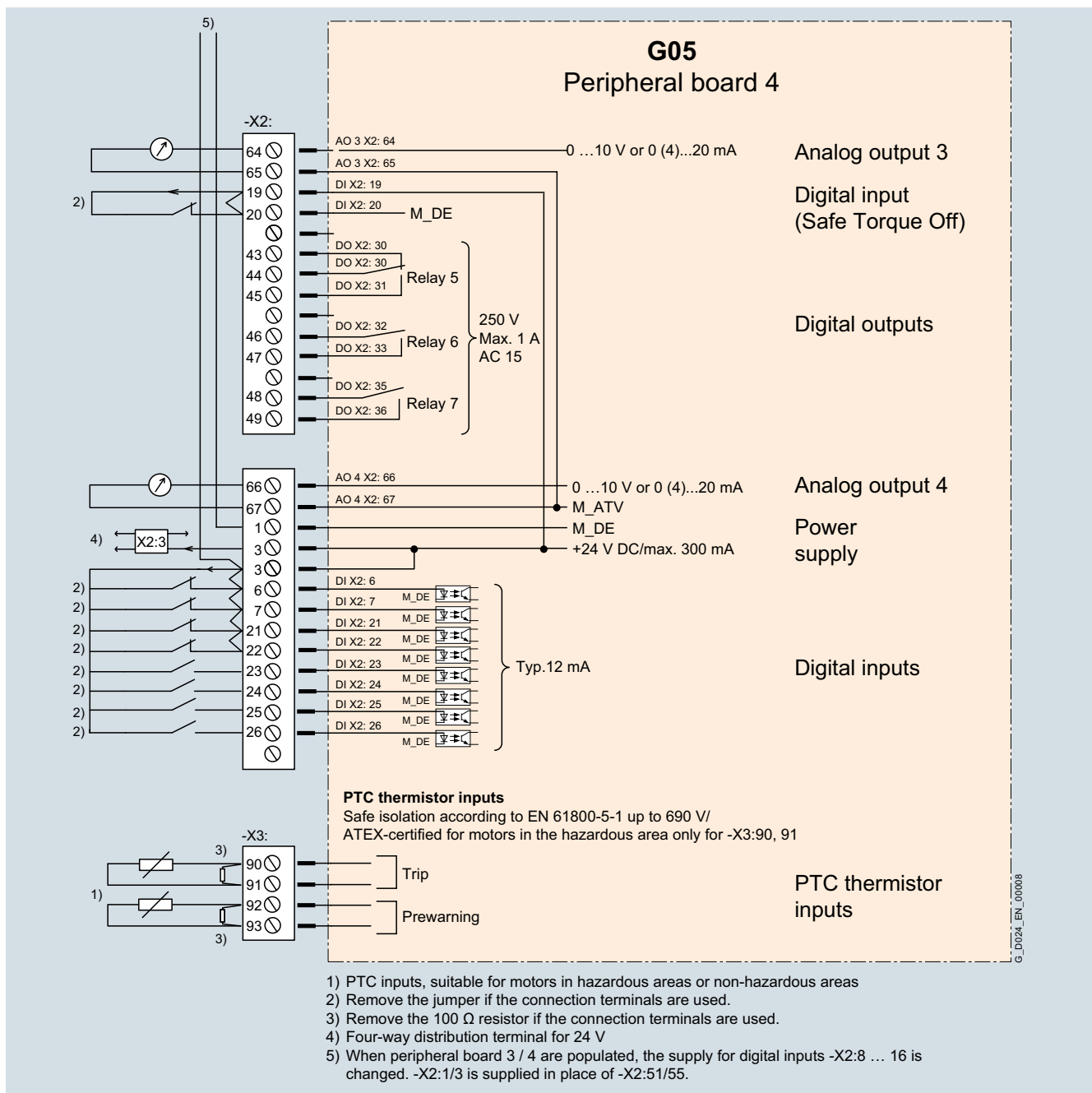

G05 Circuit diagram for peripheral board 4

Options (continued)

G10, G11, K14, K15 and K37

Control elements and display instruments in control cabinet door

Inadmissible option combinations **G10** and **G11**

Control elements and display instruments in cabinet door		G10	G11	K14	K15	K37
SENTRON PAC3200 power monitoring device (without current transformer)	G10		–	✓	✓	✓
SENTRON PAC3200 power monitoring device (with current transformer)	G11	–		✓	✓	✓
External 4-line operator panel, supplied separately packed	K14	✓	✓		✓	✓
External 4-line operator panel integrated in control cabinet door	K15	✓	✓	✓		✓
Selector switch in form of key-operated switch	K37	✓	✓	✓	✓	

✓ Options are combinable.

– Options mutually exclude each other.

G10 SENTRON PAC3200 power monitoring device (without current transformer)



G10 and G11 Line voltage display, Siemens SENTRON PAC3200

Option **G10** comprises the Siemens SENTRON PAC3200 power monitoring device without current transformer. This device is built into the cabinet door and fully wired up.

Display of:

- Line voltage
- Line frequency

Degree of protection: IP65

Dimensions (H × W × D): 96 × 96 × 51 mm

With option **G12** (PROFIBUS expansion module) the SENTRON PAC3200 can be connected to PROFIBUS.

G11 SENTRON PAC3200 power monitoring device (with current transformer)

For picture, see option **G10** "SENTRON PAC3200 power monitoring device (without current transformer)".

Option **G11** comprises the Siemens SENTRON PAC3200 power monitoring device with current transformer. This device is built into the cabinet door and fully wired up.

Display of:

- Line current
- Line voltage
- Line frequency
- Power factor
- Line harmonic THD for U and I
- Apparent power
- Reactive power
- Active power
- Apparent/reactive/active energy

Degree of protection: IP65

Dimensions (H × W × D): 96 × 96 × 51 mm

With option **G12** (PROFIBUS expansion module) the SENTRON PAC3200 can be connected to PROFIBUS.

Note:

A larger cabinet or additional cabinet may have to be planned for the current transformer.

SINAMICS G180

Option descriptions

Standard options

Options (continued)

K14 External 4-line operator panel, supplied separately packed



K14 and **K15** external operator panel

Compact units have an internal display. Using option **K14** an external display can be ordered that can be built into a door or operator panel by the customer (max. distance with external 24 V DC power supply: 1000 m).

Degree of protection: IP54

Dimensions (H × W × D): 96 × 144 × 61 mm

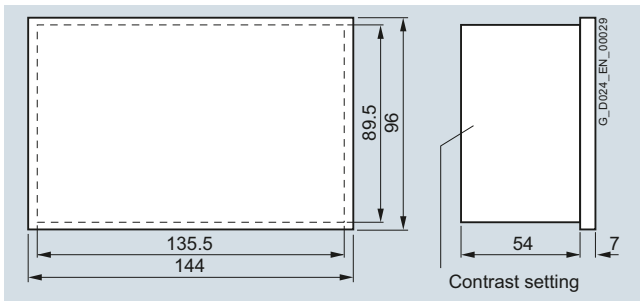

K14 Dimensional drawing of external operator panel

Note:

Without an external 24 V DC supply, the permitted length of the cable is max. 5 m (a shielded twisted-pair cable must be used as the connecting cable, e.g. LiYCY 2×2×0.25).

With option **K14** a 5 m long connecting cable is supplied.

If the cable between the converter and the operator panel is longer than 5 m, an external 24 V DC power supply unit will be required.

K15 External 4-line operator panel integrated in control cabinet door

For picture, see option **K14** "External 4-line operator panel, supplied separately packed".

Compact units have an internal display. Using option **K15** an external display can be ordered that is built into the cabinet door in the case of cabinet systems. Cabinet units generally have a display in the door.

Note:

An "internal operator panel" can be requested in place of the external operator panel (in the cabinet door of air-cooled cabinet units), see "Engineer To Order – ETO" under "Option descriptions" on Page 4/34. Option **M55** is used for this in the case of liquid-cooled cabinet units.

K37 Selector switch in form of key-operated switch



K37 Key-operated switch (example shown)

With option **K37** the selector switches that are built into the cabinet door are implemented as key-operated switches (e.g. local/remote switches). The switches must be explicitly specified in the order.

Options (continued)

L00 and L02

RFI suppression filter

Inadmissible option combinations **L00** and **L02**

RFI suppression filter		L00	L02
RFI suppression filter EN 55011 Class A	L00		–
RFI suppression filter EN 55011 Class B	L02	–	

– Options mutually exclude each other.

L00 RFI suppression filter Category C2 or C3 (Class A)

Option **L00** comprises an RFI suppression filter of Class A. This fulfills the following requirements:

- For compact units in a TN/TT system:
RFI suppression filter acc. to EN 55011 Class A and EMC product standard EN 61800-3 Category C2 (environment 1, public network)
- For cabinet units in a TN/TT system:
RFI suppression filter acc. to EN 55011 Class A and EMC product standard EN 61800-3 Category C3 (environment 2, industrial area)

Note:

Option **L00** is only permitted to be installed for devices that are intended for use in grounded networks, i.e. for 400 V devices (only permitted to be used in grounded systems) and for 500 V or 690 V devices that operate on a grounded line voltage.

For units in category C2 the following applies:

If not correctly installed and commissioned, this product can cause radio frequency interference in residential areas. In this case, it may be necessary for the operator of the unit to take further interference suppression measures.

L02 RFI suppression filter EN 55011 Class B

Option **L02** comprises an RFI suppression filter of Class B. This fulfills the following requirements for compact units:

RFI suppression filter acc. to EN 55011 Class B and EMC product standard EN 61800-3 Category C1 (environment 1, residential area).

Note:

Option **L02** is only permitted to be installed for devices that are intended for use in grounded networks, i.e. for 400 V devices (only permitted to be used in grounded systems) and for those that operate on a grounded line voltage.

L03 and L04

Line Harmonics Filter



L03/L04 Example of a Line Harmonics Filter in the cabinet unit



L03/L04 Example of a Line Harmonics Filter in the converter cabinet with compact unit

Inadmissible option combinations **L03** and **L04**

Line Harmonics Filter		L03	L04
Line Harmonics Filter for 50 Hz line frequency	L03		–
Line Harmonics Filter for 60 Hz line frequency	L04	–	

– Options mutually exclude each other.

L03 Line Harmonics Filter for 50 Hz line frequency

With option **L03** a Line Harmonics Filter for 50 Hz line frequency will be installed in the control cabinet for reducing the line-side harmonics or for compliance with IEEE 519. See the general technical data.

Note:

Please ask your Siemens contact person for the exact cabinet dimensions.

L04 Line Harmonics Filter for 60 Hz line frequency

With option **L04** a Line Harmonics Filter for 60 Hz line frequency will be installed in the control cabinet for reducing the line-side harmonics or for compliance with IEEE 519. See the general technical data.

Note:

Please ask your Siemens contact person for the exact cabinet dimensions.

SINAMICS G180

Option descriptions

Standard options

Options (continued)

L10, L14, L15, L16 and L17 Output filter

Inadmissible option combinations **L14, L15, L16, L17**

Output filter		L10	L14	L15	L16	L17
Strengthened dv/dt output filter	L10		✓	✓	✓	✓
Sine-wave filter in control cabinet, 75 Hz; 10 % voltage drop	L14	✓		–	–	–
Sine-wave filter in control cabinet, 60 Hz; 10 % voltage drop	L15	✓	–		–	–
Sine-wave filter IP00 supplied separately, 75 Hz; 10 % voltage drop	L16	✓	–	–		–
Sine-wave filter in control cabinet, 75 Hz; 5 % voltage drop	L17	✓	–	–	–	

✓ Options are combinable.

– Options mutually exclude each other.

L10 Strengthened dv/dt output filter for max. 250/300 m (type-dependent) – design for longer motor cables available on request



L10 Output filter (example of filter reactor)

All SINAMICS G180 converters are fitted with a dv/dt filter as standard that are suitable for motor cable lengths (depending on the power rating, see technical data) from 100 to 200 m typically. Standard motors with standard insulation can be used.

With option **L10** a strengthened dv/dt output filter is selected. The strengthened dv/dt output filter typically extends the possible motor cable length (depending on the power rating, see technical data) as follows:

- Shielded cables: 250 to 300 m (e.g. NYCWY)
- Unshielded cables: 300 to 450 m (e.g. NYY)

These cable lengths are based on worst-case conditions. If the motor cable lengths are longer in a special case, the feasibility can be checked in the factory. The cable types, their number and length must be known for this purpose.

Method of operation:

The dv/dt filter in SINAMICS G180 limits the voltage gradient (dv/dt) and the peak voltage \hat{U}_{LL} for the motor winding to the following values:

- Voltage gradient dv/dt < 1500 V/μs
- Peak voltages \hat{U}_{LL} (typically) < 1560 V

Various explosion protection regulations (ATEX) specify a maximum permissible average peak voltage at the motor (IEC 60034-25-A) of 1560 V (LHX2 motor winding) and a permissible maximum terminal voltage at the motor (explosion-proof motors only) of 1866 V.

Design:

SINAMICS G180 dv/dt filters mainly comprise a dv/dt reactor and a voltage limiting network that limits the voltage peaks.

Reduction of voltage peaks using dv/dt filters normally obviates the need for special insulation of the motors. The filter also has a positive effect on the bearing currents (reduction of bearing currents).

Voltage drop:

The voltage drop in the converter is compensated using the "Overmodulation" software function in which case the output voltage of the converter is almost equal to the input voltage.

L14 Sine-wave filter integrated in control cabinet or additional cabinet, suitable for motor frequencies of ≤ 75 Hz, voltage drop approx. 10 % of the line voltage



L14 Sine-wave filter (example shown)

With option **L14** a sine-wave filter for motor frequencies of ≤ 75 Hz is integrated in the control cabinet.

Sine-wave filters should largely suppress the clock-frequency harmonics at the motor terminals to the extent that the voltage approximates a sinusoidal wave. They are implemented as LC networks.

Due to the large voltage drop of a sine-wave filter, it should normally be checked before it is used whether a dv/dt filter would suffice for the application case. To check this, please send the necessary data (cable length, cable type, cable cross-section, number of parallel cables) to your Siemens contact person.

Note:

The voltage drop at the sine-wave filter can cause an unacceptable temperature rise in the motor.

Voltage drop approximately 10 % of the line voltage.

The voltage drop can be compensated by using a sine-wave filter with a step-up transformer. If this is required, please ask your Siemens contact person.

The cabinet dimensions may increase as a result.

Options (continued)

L15 Sine-wave filter integrated in control cabinet or additional cabinet, suitable for motor frequencies ≤ 60 Hz, voltage drop approx. 10 % of the line voltage

With option **L15** a sine-wave filter for motor frequencies of ≤ 60 Hz is integrated in the control cabinet.

Sine-wave filters should largely suppress the clock-frequency harmonics at the motor terminals to the extent that the voltage approximates a sinusoidal wave. They are implemented as LC networks.

Due to the large voltage drop of a sine-wave filter, it should normally be checked before it is used whether a dv/dt filter would suffice for the application case. To check this, please send the necessary data (cable length, cable type, cable cross-section, number of parallel cables) to your Siemens contact person.

Note:

The voltage drop at the sine-wave filter can cause an unacceptable temperature rise in the motor.

Voltage drop approximately 10 % of the line voltage.

The voltage drop can be compensated by using a sine-wave filter with a step-up transformer. If this is required, please ask your Siemens contact person.

The cabinet dimensions may increase as a result.

L16 Sine-wave filter IP00 for compact unit, suitable for motor frequencies of ≤ 75 Hz, voltage drop of approx. 5 % of the line voltage (supplied separately packed)

With option **L16** a sine-wave filter for motor frequencies of ≤ 75 Hz is supplied separately packed with the compact unit.

Sine-wave filters should largely suppress the clock-frequency harmonics at the motor terminals to the extent that the voltage approximates a sinusoidal wave. They are implemented as LC networks.

Due to the large voltage drop of a sine-wave filter, it should normally be checked before it is used whether a dv/dt filter would suffice for the application case. To check this, please send the necessary data (cable length, cable type, cable cross-section, number of parallel cables) to your Siemens contact person.

Note:

The voltage drop at the sine-wave filter can cause an unacceptable temperature rise in the motor.

Voltage drop approximately 5 % of the line voltage.

The voltage drop can be compensated by using a sine-wave filter with a step-up transformer. If this is required, please ask your Siemens contact person.

L17 Sine-wave filter integrated in control cabinet or additional cabinet, suitable for motor frequencies ≤ 75 Hz, voltage drop approx. 5 % of the line voltage

With option **L17** a sine-wave filter for compact units and motor frequencies of ≤ 75 Hz is integrated in the cabinet system.

Sine-wave filters should largely suppress the clock-frequency harmonics at the motor terminals to the extent that the voltage approximates a sinusoidal wave.

Due to the large voltage drop of a sine-wave filter, it should normally be checked before it is used whether a dv/dt filter would suffice for the application case. To check this, please send the necessary data (cable length, cable type, cable cross-section, number of parallel cables) to your Siemens contact person.

This voltage drop can cause an unacceptable temperature rise in the motor.

Voltage drop approximately 5 % of the line voltage.

The voltage drop can be compensated by using a sine-wave filter with a step-up transformer. If this is required, please ask your Siemens contact person.

L48, L49, L50, L55, N35, N36, Y11 and Y98 Accessories

L48 Grounding socket outlet 230 V, 50 Hz, 10 A, in control cabinet with 30 mA ground-fault circuit interrupter, external incoming supply

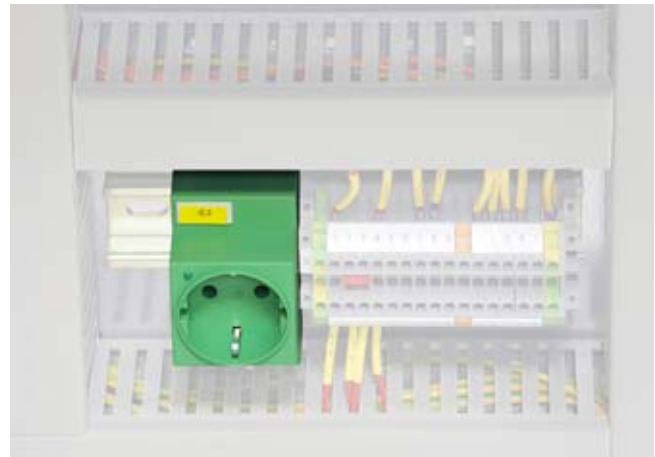

L48 Grounding socket outlet (example shown)

Option **L48** comprises one 230 V/50 Hz grounding socket outlet in the control cabinet with a 30 mA ground-fault circuit interrupter and 10 A /B miniature circuit breaker, e.g. for notebook (service).

The socket outlet is supplied from an external incoming supply provided by the customer; the terminals are provided in the converter for this.

Note:

If a plug system other than the SCHUKO grounding system is used, e.g. a British or US plug system, please specify this in the order.

SINAMICS G180

Option descriptions

Standard options

Options (continued)

L49 Grounding socket outlet 230 V, 50 Hz, 1 A, in control cabinet with 30 mA ground-fault circuit interrupter, supplied internally

Option **L49** comprises one 230 V/50 Hz grounding socket outlet in the control cabinet with a 30 mA ground-fault circuit interrupter and 1 A /C miniature circuit breaker, e.g. for notebook (service).

The socket outlet is supplied from an internal control transformer.

If a plug system other than the SCHUKO grounding system is used, e.g. a British or US plug system, please specify this in the order.

L50 Magnetically attached control cabinet light and door contact switch



L50 Control cabinet light (example shown)

The light is fitted with a fluorescent lamp (8 W) without a socket outlet. It is attached using magnets which ensures a high degree of flexibility.

The lamp is switched via a door contact and supplied via an internal control transformer. The light is installed in the control cabinet.

L55 Cabinet heater to protect against condensation and/or operation with supply air temperature of -5 °C or below



L55 Cabinet heater (example shown)

With option **L55** cabinet heaters are used with 250 W per control cabinet.

Cabinet heaters are recommended at low ambient temperatures and high levels of humidity to prevent condensation or frost damage. The number of cabinet heaters installed is determined by the number of cabinet sections.

Cabinet heaters should be used above:

- 85 % air humidity. The maximum permissible air humidity in the switchroom is 95 % (condensation is not permitted).
- -5 °C supply air during operation. The minimum ambient temperature for air-cooled converters is 0 °C in the switchroom.

The heater is controlled by a thermostat built into the control cabinet. It is supplied from the installed control voltage transformer or, if required, from an external control voltage supply.

Available as an ETO option:

- Cabinet heaters with increased output for temperatures between -5 ° and -10 °C.
- The cabinet heater is controlled by a hygrostat.

N35 Controlled outgoing feeder for motor heater, voltage 230 V 1 AC, max. 4 kW

This option is used when the driven motor is equipped with a heater that is supplied from the converter. It is important to note that the heater voltage is identical to the control voltage, normally 230 V/50 Hz.

The outgoing feeder can be controlled internally by the converter or externally.

The heater data (voltage/power) of the heater must be included in the order.

N36 Controlled outgoing feeder for external motor fan – external fan voltage for 3 AC. Converter line voltage, max. 4 kW

This option is used when the driven motor is equipped with an external fan motor that is supplied from the converter. It is important to note that the external fan voltage must be identical to the line voltage.

The outgoing feeder can be controlled internally by the converter or externally. The motor data (voltage/current) of the external fan motor must be included in the order.

Y11 Undervoltage release for main switch or circuit breaker; specify coil voltage

With option **Y11** an undervoltage release will be installed for a main switch or circuit breaker. The voltage for this release must be specified.

Application examples:

- In combination with options **S01** or **S02** and the externally backed-up control voltage of the converter, Safety Integrity Level (SIL) 3 according to EN 61508 can be achieved. There is no need for a second main contactor.
Disadvantage:
Automatic reset is not possible, because the main switch or circuit breaker must be reclosed manually. An externally backed-up control voltage is necessary.
- With an undervoltage release, Safety Integrity Level (SIL) 1 can be achieved without a main contactor and without an EMERGENCY OFF relay.
Disadvantage:
Automatic reset is not possible, because the main switch or circuit breaker must be reclosed manually. An externally backed-up control voltage is necessary.

Note:

Please specify the application case in the order.

Options (continued)

Y98 Controlled outgoing feeder for auxiliary drive up to max. 4 kW, please specify type of drive, voltage and number of phases

With option **Y98** an outgoing feeder is prepared for an auxiliary drive of up to 4 kW. Please specify the voltage and number of phases as well as the type of drive or function description.

The outgoing feeder can be controlled internally by the converter or externally.

Note:

The voltage for the auxiliary drive must be less than or equal to the line voltage.

L72

Braking chopper

L72 Braking chopper integrated into converter (braking resistor is not included and must be ordered separately)

During motor operation the electrical power flow is from the converter to the motor. During generator operation the electrical power flow is from the motor to the converter (braking of rotating masses, active loads).

The standard version of SINAMICS G180 cannot feed energy back into the system. During braking operation kinetic energy can be converted into heat loss. Approx. 10 % of the braking torque is available in the upper speed range. A braking torque up to 50 % can be achieved without a supplementary device in the mid and lower speed range through oversaturation of the motor. The braking chopper accessory allows an external braking resistor to be connected. The braking torque varies in accordance with the converter type and resistance value. The energy generated is converted to heat via the braking transistor in the braking resistor. Any questions regarding braking resistors and the maximum possible braking torque should be addressed to your Siemens contact person.

A thermal model of the braking resistor incorporated into the converter firmware protects the resistor from overload.

L80, L81, L82, L83 and Y80 **CALOMAT CK145**



L80 CALOMAT CK145

The CALOMAT CK145 for monitoring motors, transformers, etc. with PTC thermistor temperature sensors to DIN 44081, especially explosion-proof motors, is certified to ATEX 95 (Directive 94/9 EC). The requirements of EN 61800-5-1 – Basic requirements for protective separation in electrical equipment – are also fulfilled in the sensor circuit and between the changeover contacts. Destruction of the supervisory control system due to an insulation fault on the PTC thermistor is almost totally prevented.

The CALOMAT in IP20 degree of protection is uniformly 22.5 mm wide and suitable for mounting on a standard rail to DIN EN 50022. The two changeover contacts can be used for disconnecting the system and for outputting alarms to a higher-level control system. The status of the monitoring circuit is signaled by LEDs for Operation (green) and Fault (red). The CK145 also features a LED for sensor break or sensor short-circuit.

The following generally applies:

- CALOMAT thermal motor protection with ATEX certification.
- Directive 94/9/EC, installed in the control cabinet.
- Devices with protective separation to EN 61800-5-1.
- The general health and safety requirements are fulfilled due to compliance with EN 60947-1/EN 60947-5-1/DIN VDE 0660 Part 302 and Part 303/EN 60079-14.
- Sensor circuit: max. 6 PTC thermistors (< 1.5 kΩ).
- Acknowledgment button on device and remote acknowledgment is possible.

Note:

When CALOMAT devices with a switch-off function are used, a line contactor must be installed on the input side (option **S01** or **S02**) for compliance with ATEX 95 (Directive 94/9 EC).

CALOMAT devices are used in special cases, e.g. identical design to previously supplied equipment, or for evaluating several PTC thermistors. Otherwise, for evaluating PTC thermistors, peripheral board 2 (option **G03**) or peripheral board 4 (option **G05**) must be used.

SINAMICS G180

Option descriptions

Standard options

Options (continued)

L80 CALOMAT CK145 without storage for motor temperature prewarning

With this option, the motor prewarning temperature limit is monitored using up to 6 PTC thermistors. If the prewarning temperature is exceeded an alarm is output to the converter. The fault is not stored on the CALOMAT and therefore does not require acknowledgement.

L81 CALOMAT CK145 with storage for motor temperature trip

With this option, the motor trip temperature limit is monitored using up to 6 PTC thermistors. If the trip temperature is reached an alarm is output to the converter. The converter switches itself off. The fault is stored on the CALOMAT and therefore has to be acknowledged.

Note:

When CALOMAT devices are used for switch-off, a line contactor must be installed on the input side (option **S01** or **S02**) for compliance with ATEX 95 (Directive 94/9 EC).

L82 CALOMAT CK145 without storage for transformer temperature prewarning

With this option, the transformer prewarning temperature limit is monitored using up to 6 PTC thermistors. If the prewarning temperature is exceeded an alarm is output to the converter. The fault is not stored on the CALOMAT and therefore does not require acknowledgement.

L83 CALOMAT CK145 with storage for transformer temperature trip

With this option, the transformer trip temperature limit is monitored using up to 6 PTC thermistors. If the trip temperature is reached an alarm is output to the converter. The converter switches itself off. The fault is stored on the CALOMAT and therefore has to be acknowledged.

Note:

When CALOMAT devices are used for switch-off, a line contactor must be installed on the input side (option **S01** or **S02**) for compliance with ATEX 95 (Directive 94/9 EC).

Apart from disconnecting the converter, it is also recommended that the already existing tripping device on site is disconnected that is connected upstream of the transformer, such as the medium-voltage switch.

Y80 CALOMAT CK145 for other PTC thermistor temperature monitoring functions

With this option, a temperature limit is monitored using up to 6 PTC thermistors. If the temperature limit is reached an alarm is output to the converter. Please specify whether the fault should be stored on the CALOMAT and therefore has to be acknowledged or not.

L87

Insulation monitoring

L87 Integrated insulation monitoring system for operation on the secondary side of unit transformer in an IT system



L87 Insulation monitoring

An insulation monitor must be used if the converter is connected to a three-winding transformer. The insulation monitor IRDH 275 from Bender monitors the entire galvanically coupled circuit for insulation faults.

This option is included as standard fully wired up in the cabinet for insulation monitoring with 12-pulse and higher-pulse converters on a unit transformer that is not grounded on the secondary side.

Function:

The insulation resistance of all galvanically coupled components (converter transformer secondary winding, cables, converter, motor) is monitored by means of a measured signal that is modulated onto the line supply. If the insulation resistance is undershot, an alarm or trip message is output.

Notice:

Only ONE insulation monitoring device at a time is permitted in the entire galvanically coupled network. False tripping occurs if 2 devices are used. This option is therefore only suitable for converter operation with one converter.

Options (continued)

L90, L91, L92, L93, L94, Y90 and Y94
Pt100 evaluation unit

Inadmissible option combinations **L90, L92 and L94** as well as **L91, L93 and L94**

Output filter		L90	L91	L92	L93	L94	Y90	Y94
Pt100 evaluation unit for motor winding temperature, integrated in control cabinet for monitoring of 3 × Pt100 or 3 × KTY83/84 sensors.	L90		✓	–	✓	–	✓	✓
Pt100 evaluation unit for motor bearing temperature, integrated in control cabinet for monitoring of 2 × Pt100 or 2 × KTY83/84 sensors.	L91	✓		✓	–	–	✓	✓
Pt100 evaluation unit for motor winding temperature, integrated in control cabinet for monitoring 3 × Pt100 sensors; plus an analog output 0 to 10 V or 0(4) to 20 mA connected to terminals for the hottest winding temperature.	L92	–	✓		✓	–	✓	✓
Pt100 evaluation unit for motor bearing temperature, integrated in control cabinet for monitoring 2 × Pt100 sensors or 2 × KTY83/84 sensors; plus two analog outputs 0 to 10 V or 0(4) to 20 mA connected to terminals for bearing temperature.	L93	✓	–	✓		–	✓	✓
Pt100 evaluation unit for motor winding and bearing temperatures, integrated in control cabinet for monitoring 6 × Pt100 sensors; plus two analog outputs 0 to 10 V or 0(4) to 20 mA connected to terminals for the hottest winding and bearing temperatures.	L94	–	–	–	–		✓	✓
Pt100 evaluation unit for other temperature monitoring functions, integrated in control cabinet for monitoring of 3 × Pt100 or 3 × KTY83/84 sensors.	Y90	✓	✓	✓	✓	✓		✓
Pt100 evaluation unit for other temperature monitoring functions, integrated in control cabinet for monitoring 6 × Pt100 sensors; plus two analog outputs 0 to 10 V or 0(4) to 20 mA connected to terminals.	Y94	✓	✓	✓	✓	✓	✓	

✓ Options are combinable.

– Options mutually exclude each other.

L90 Pt100 evaluation unit for motor winding temperature, integrated in control cabinet for monitoring of 3 × Pt100 or 3 × KTY83/84 sensors



L90 Siemens 3RS1041-1GW50

Pt100 evaluation unit for motor winding temperature, integrated for 3 × Pt100/1000 or 3 × KTY83/84 sensors with temperature indication on evaluation unit, alarm and trip message on converter display or integrated into the group warning or group fault.

Note:

Please specify alarm and trip limits in the order for motors that are not included in the scope of supply.

L91 Pt100 evaluation unit for motor bearing temperature, integrated in control cabinet for monitoring of 2 × Pt100 or 2 × KTY83/84 sensors

Pt100 evaluation unit for motor bearing temperature, integrated in control cabinet for 2 × Pt100/1000 or 2 × KTY83/84 sensors; temperature indication on evaluation unit, alarm and trip message on converter display or integrated into the group warning or group fault.

Note:

Please specify alarm and trip limits in the order for motors that are not included in the scope of supply.

SINAMICS G180

Option descriptions

Standard options

Options (continued)

L92 Pt100 evaluation unit for motor winding temperature, integrated in control cabinet for monitoring 3 × Pt100 sensors; plus an analog output 0 to 10 V or 0(4) to 20 mA connected to terminals for the hottest winding temperature



L92 Pt100 Ziehl TR400

Pt100 evaluation unit for 3 × Pt100 sensors for 3 winding sensors (1 reserve), installed in the control cabinet. With temperature indication on the evaluation unit; alarm and trip message on the converter display or integrated in the group warning or group fault.

Also one analog output 0 to 10 V or 0(4) to 20 mA for the hottest winding temperature for further processing, e.g. in the main control system; applied to terminals.

Note:

Please specify alarm and trip limits in the order for motors that are not included in the scope of supply.

L93 Pt100 evaluation unit for motor bearing temperature, integrated in control cabinet for monitoring 2 × Pt100 sensors or 2 × KTY83/84 sensors; plus two analog outputs 0 to 10 V or 0(4) to 20 mA connected to terminals for bearing temperature

Pt100 evaluation unit for 2 × Pt100 sensors or 2 × KTY83/84 sensors for motor bearing temperature, integrated in the control cabinet. With temperature indication on the evaluation unit; alarm and trip message on the converter display or integrated in the group warning or group fault.

Also two analog outputs 0 to 10 V or 0(4) to 20 mA for the bearing temperature for further processing, e.g. in the main control system; applied to terminals.

Note:

Please specify alarm and trip limits in the order for motors that are not included in the scope of supply.

L94 Pt100 evaluation unit for motor winding and bearing temperatures, integrated in control cabinet for monitoring 6 × Pt100 sensors; plus two analog outputs 0 to 10 V or 0(4) to 20 mA connected to terminals for the hottest winding and bearing temperatures



L94 Pt100 Ziehl TR600

Pt100 evaluation unit for 6 × Pt100 sensors for 3 winding sensors and 2 bearing sensors (1 reserve), integrated in the control cabinet; temperature indication on evaluation unit; alarm and trip message on converter display or integrated into the group warning or group fault.

Also one analog output 0 to 10 V or 0(4) to 20 mA for the hottest winding temperature and one analog output 0 to 10 V or 0(4) to 20 mA for the hottest bearing temperature for further processing, e.g. in the main control system; applied to terminals.

Note:

Please specify alarm and trip limits in the order for motors that are not included in the scope of supply.

Y90 Pt100 evaluation unit for other temperature monitoring functions, integrated in control cabinet for monitoring of 3 × Pt100 or 3 × KTY83/84 sensors

For image, see option **L90** Siemens 3RS1041-1GW50.

Pt100 evaluation unit for motor winding temperature, integrated in control cabinet for 3 × Pt100/1000 or 3 × KTY83/84 sensors; temperature indication on evaluation unit, alarm and trip message on converter display or integrated into the group warning or group fault.

Note:

Please specify alarm and trip limits or which temperatures should be monitored in the order.

Y94 Pt100 evaluation unit for other temperature monitoring functions, integrated in control cabinet for monitoring 6 × Pt100 sensors; plus two analog outputs 0 to 10 V or 0(4) to 20 mA connected to terminals

For image, see option **L94** Pt100 Ziehl TR600.

Pt100 evaluation unit for 6 × Pt100 sensors integrated in control cabinet; temperature indication on evaluation unit; alarm and trip message on converter display or integrated into the group warning or group fault.

Also two analog outputs 0 to 10 V or 0(4) to 20 mA applied to terminals.

Options (continued)

Note:

Please specify alarm and trip limits or which temperatures should be monitored in the order.

M05, M06, M07, M13, M17, M19, M24, M28, M34, M38, M39, M40, M59, M78, Y09 and Y19 Cabinet options

M05 Control cabinet base, welded and suitable for use with transport rollers in RAL 7022, height 200 mm

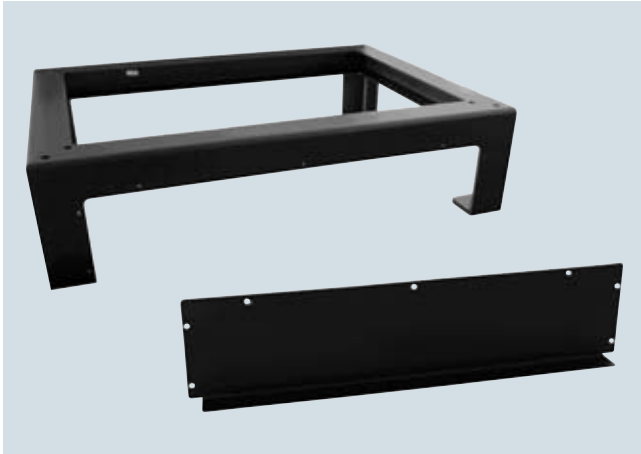

M05 Control cabinet base, welded

The control cabinet base allows larger bending radii for cables (cable inlet from below) and enables them to be routed within the control cabinet base.

The control cabinet base is welded and suitable for use with transport rollers. The standard color is RAL 7022; a special paint finish for the control cabinet base is not possible. It is delivered completely assembled with the cabinet.

Base element 200 mm painted (RAL 7022).

Note:

The control cabinet base is supplied fully assembled with the converter cabinet.

M06 Control cabinet base RAL 7022/9005 as standard, height 100 mm



M06 Control cabinet base

The control cabinet base allows larger bending radii for cables (cable inlet from below) and enables them to be routed within the control cabinet base.

The standard color is RAL 7022/9005; a special paint finish for the control cabinet base is not possible. The height is 100 mm.

Note:

For transport reasons, the control cabinet bases are delivered separately or packed alongside the cabinet and must be mounted on site before the cabinet is assembled.

M07 Control cabinet base RAL 7022/9005 as standard, height 200 mm

For image, see option **M06** Control cabinet base.

The control cabinet base allows larger bending radii for cables (cable inlet from below) and enables them to be routed within the control cabinet base.

The standard color is RAL 7022/9005; a special paint finish for the control cabinet base is not possible. The height is 200 mm.

Note:

For transport reasons, the control cabinet bases are delivered separately or packed alongside the cabinet and must be mounted on site before the cabinet is assembled.

M13 Cable entry from the top: power cable

With option **M13** the cables for mains connection will enter the control cabinet from the top.

The width of the cabinet may increase depending on the converter type and equipment. Please contact the factory regarding the exact dimensions of the converter with this option.

M34 Cable entry from the top: control cables

With option **M34** the cables for the control cables will enter the cabinet from the top.

The width of the cabinet may increase depending on the converter type and equipment. Please contact the factory regarding the exact dimensions of the converter with this option.

M78 Cable entry from the top: motor cables

With option **M78** the motor cables will enter the control cabinet from the top.

The width of the cabinet may increase depending on the converter type and equipment. Please contact the factory regarding the exact dimensions of the converter with this option.

SINAMICS G180

Option descriptions

Standard options

Options (continued)

M17 Door opening angle 180°



M17 Door opening angle 180°

With option **M17** all standard hinges are replaced with 180° hinges. The converter cabinet door can therefore normally open 180°, but the opening angle may be reduced by components installed in the control cabinet door.

M19 Window in door for viewing internal display



M19 Example of window in door for viewing internal display

With this option, an inspection window is installed in the control cabinet door. The internal converter display can be read through this.

M24 Partitions between compact units for cabinet systems



M24 Partitions between the compact units (example shown)

Partitions can be used between compact units in cabinet systems to implement clear separation of the converter with the associated controller.

M28 Door hinge on left



M28 Door hinge on left

The SINAMICS G180 converter is supplied as standard up to a cabinet width of 800 mm with the door hinged on the right (hinges on right). With this option, the doors are hinged on the left (hinges on left).

Note:

This option is not possible in the case of double doors (cabinet width 1000 mm or 1200 mm).

Options (continued)

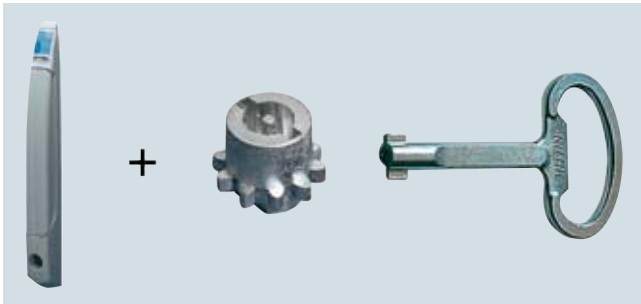
M38 Comfort-grip handle with double-bit key lock**M38** Comfort-grip handle with double-bit key lock (example shown)

It is unlocked using a standard double-bit key. The unlocked handle unfolds forwards and is lifted to open the lock.

- Material: die-cast zinc
- Surface: powder-coated
- Standard version in RAL 7035

M39 Comfort-grip handle with integrated pushbutton**M39** Comfort-grip handle with integrated pushbutton (example shown)

It is unlocked using a pushbutton insert. The unlocked handle unfolds forwards and is lifted to open the lock. The cabinet door can then be opened easily without the need for additional tools.

- Material: die-cast zinc
- Surface: powder-coated
- Standard version in RAL 7035

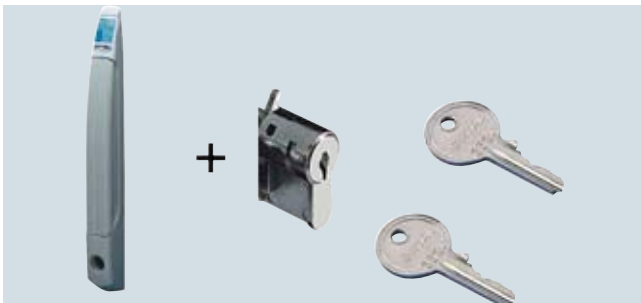
M40 Comfort-grip handle with cylinder lock**M40** Comfort-grip handle with cylinder lock (example shown)

A safety insert is used for unlocking, lock No. 3514 E with 2 keys. The unlocked handle unfolds forwards and is lifted to open the lock.

- Material: die-cast zinc
- Surface: powder-coated
- Standard version in RAL 7035

M59 Air supply via cable floor (no need for filter elements in the door)

If the converter cabinet is erected on a false floor or duct which forms part of a forced ventilation system, the converter can be ordered with closed cabinet doors. To ensure an adequate air inlet cross-section, the units are shipped without the standard base plates. In this case, the customer must ensure that no dirt/dust or moisture can enter the converter. Cables must not be routed in such a way that they impede the flow of air through the cabinet floor opening. If the area beneath the converter can be accessed, the customer must provide touch protection.

Y09 Special control cabinet paint color: Please specify RAL**Y09** Example special paint

As standard, the converter cabinet units are delivered in RAL 7035. The special paint finish must be stated in plain text in the order. All RAL colors which are available as powder coatings can be selected. This may extend the delivery time.

Important:

The protective top cover for IP21 and the protective top cover in option **M43** is supplied in RAL 7035 as standard, but it can also be painted in the special paint of the cabinet **Y09**. This must be specified in the order in which case the delivery time may be extended. If a special color is requested for the cabinet (Order code **Y09**), the top cover in option M54 is also painted in this color. The molded plastic parts (e.g. ventilation grilles) are colored RAL 7035 and cannot be painted.

SINAMICS G180

Option descriptions

Standard options

Options (continued)

Y19 Window in door for viewing internal components



Y19 Example of window in door for viewing internal components

With this option, an inspection window is installed in the control cabinet door. An internal component can be read through this.

M21, M41, M43, M54, M55 and M63 Degrees of protection

The EN 60529 standard covers the protection of electrical equipment by means of housings, covers or equivalent, and includes:

- Protection of persons against accidental contact with live or moving parts within the housing and protection of the equipment against the ingress of solid foreign matter (touch protection and protection against ingress of solid foreign matter)

- Protection of the equipment against the ingress of water (water protection)
- Abbreviations for the internationally agreed degrees of protection

The degrees of protection are specified by abbreviations comprising the code letters IP and two digits.

Degree of protection	First digit (touch protection and protection against ingress of solid foreign matter)	Second digit (protection of the equipment against the ingress of water)
IP20 • Standard for compact units without protective top cover • Cabinet units and systems with the cabinet door open	Protected against solid foreign matter, diameter ≥ 12.5 mm	No water protection
IP21 • Option M21 for compact units • Standard for air-cooled cabinet units and systems	Protected against solid foreign matter, diameter ≥ 12.5 mm	Protected against drip water Vertically falling water drops shall not have a harmful effect.
IP41 Option M41 for cabinet units and systems	Protected against solid foreign matter, diameter ≥ 1 mm	Protected against drip water Vertically falling water drops shall not have a harmful effect.
IP43 Option M43 for cabinet units and systems	Protected against solid foreign matter, diameter ≥ 1 mm	Protected against spray water Water sprayed on both sides of the vertical at an angle of up to 60° shall not have a harmful effect.
IP54 Option M54 for cabinet units (standard for liquid-cooled cabinet units)	Protected against dust Ingress of dust is not totally prevented, but dust must not be allowed to enter in such quantities that the functioning or safety of the equipment is impaired.	Protected against splash water Water splashing onto the enclosure from any direction shall not have a harmful effect.
IP55 Option M55 for cabinet units	Protected against dust Ingress of dust is not totally prevented, but dust must not be allowed to enter in such quantities that the functioning or safety of the equipment is impaired.	Protected against jet-water Water splashing onto the enclosure from any direction (nozzle) shall not have a harmful effect.

The devices are intended for indoor installation and are suitable for climatic environmental conditions of Class 3K3 according to EN 60721, higher requirements fulfilled on request.

Note:

For transport reasons, the top covers are delivered separately and must be fitted on site.

The protective top cover for IP21 and the protective top cover in option **M43** is supplied in RAL 7035 as standard, but it can also be painted in the special paint of the cabinet **Y09**. This must be specified in the order in which case the delivery time may be extended. If a special color is requested for the cabinet (Order

code **Y09**), the top cover in option **M54** is also painted in this color. The molded plastic parts (e.g. ventilation grilles) are colored RAL 7035 and cannot be painted.

Options (continued)

M21 Increased degree of protection IP21 for compact units

With option **M21** a protective top cover is supplied separately packed for the compact units. The top cover is 5 mm wider on both sides than the converter. This clearance must be taken into account when installing side-by-side. The air discharge area must be left clear at the front.

M41 Increased degree of protection IP41 for air-cooled cabinet units and systems

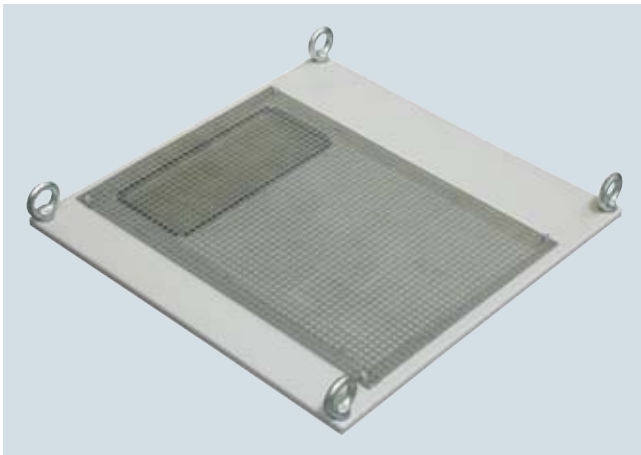

M41 Fine-mesh wire grid (example shown)

With option **M41** the filter fan or outlet filter is covered with a fine-mesh wire grid in addition to the IP21 top cover.

M43 Increased degree of protection IP43 for air-cooled cabinet units and systems

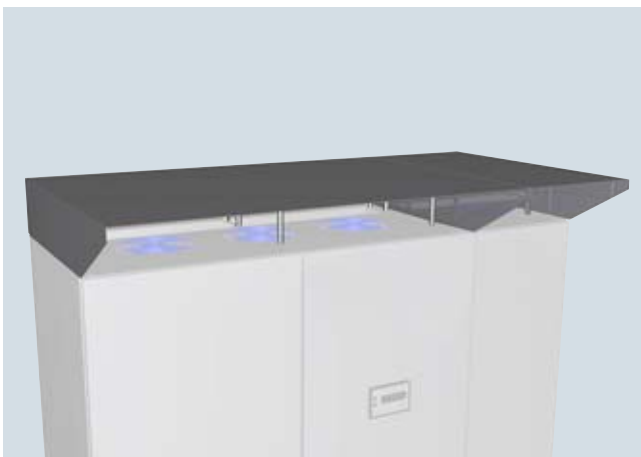

M43 IP43 top cover (example shown)

With option **M43** IP43 degree of protection is achieved using the following combination:

- Top cover IPX3 + fine-mesh wire grid in the filter fan or outlet filter

M54 Increased degree of protection IP54 for air-cooled cabinet units and systems (not suitable for outdoor applications)



M54 Labyrinth top cover (example shown)

With option **M54** IP54 degree of protection is achieved using the following combination:

- Labyrinth top cover + filter mat (open-cell polyurethane foam) in filter fan or outlet filter
- With option **M63** (air flange for connection to customer's exhaust air systems; air outlet IP00) + filter mat (open-cell polyurethane foam) in filter fan or outlet filter
- Standard degree of protection for liquid-cooled cabinet units

M55 Increased degree of protection IP55 for liquid-cooled cabinet units (no display in cabinet door)

IP55 degree of protection is achieved with option **M55** by omitting the converter operator panel or other built-in components with a low degree of protection in the cabinet door in the case of liquid-cooled converters. Additional measures are not required.

M63 Air flange for connection to customer's exhaust air systems (air outlet IP00)



M63 Air flange (example shown)

With option **M63** an air flange is provided on the converter. This allows the SINAMICS G180 to be connected to an external exhaust air system so that IP54 degree of protection is achieved.

Important:

For transport reasons, the air flanges are delivered separately and must be fitted on site.

SINAMICS G180

Option descriptions

Standard options

Options (continued)

M20 and N50

Wiring options

M20 Minimum cross-section of the internal cabinet wiring 1.5 mm²

With option **M20** the internal wiring of the controller in the converter is implemented using a minimum conductor cross-section of 1.5 mm². Individual electronics leads, such as flat ribbon cables are excluded from this.

N50 Use of halogen-free cables inside cabinet

With option **N50** halogen-free cables are used. Individual electronics leads, such as flat ribbon cables are excluded from this.

Q80, Q81, Q82, Q83, Q84 and Q85

Extension of the liability for defects

Option	Description
Q80	Extension of the liability for defects by 12 months as of commissioning date or by 24 months as of delivery date
Q81	Extension of the liability for defects by 18 months as of commissioning date or by 30 months as of delivery date
Q82	Extension of the liability for defects by 24 months as of commissioning date or by 36 months as of delivery date
Q83	Extension of the liability for defects by 30 months as of commissioning date or by 42 months as of delivery date
Q84	Extension of the liability for defects by 36 months as of commissioning date or by 48 months as of delivery date
Q85	Extension of the liability for defects by 48 months as of commissioning date or by 60 months as of delivery date

Conditions for an extension of the liability for defects:

- For all extension periods of liability for defects, for new and subsequent orders, the final destination of the product must be known. The EUNA process is available to obtain this information at www.siemens.com/euna, which must be performed by your local Siemens contact person.
- For all 4 and 5 year extension periods of the liability for defects (**Q84, Q85**), this is only possible in conjunction with a corresponding maintenance contract with regular inspections. This maintenance contract must be signed and concluded with the responsible service department. This must be documented using the EUNA procedure at www.siemens.com/euna, which must be performed by your local Siemens contact person.
- The general storage conditions described in the operating instructions must be adhered to, especially the specifications for long-term storage.
- Commissioning must be performed by appropriately qualified personnel. When making liability for defect claims, under certain circumstances, it may be necessary to submit the commissioning report to the department making the decision.
- Periodic maintenance must be performed in accordance with the specifications of the operating instructions. When making liability for defect claims, under certain circumstances, it may be necessary to submit the corresponding maintenance documentation and history.
- The operating conditions correspond to the specifications in the operating instructions, the installation instructions or specific conditions laid down in the contract.
- The extended liability for defects excludes wearing parts such as fans or filters. This does not apply if it can be clearly proven that the failure is a premature one.
- Otherwise, the general conditions regarding liability for defects apply as agreed in the delivery contract.

Options (continued)

S01, S02, S03, S04, S06, S08, S09, S11, S12, S21, S22, S23, S24, S31, S32, S41 and G08
Standard accessories packages

Standard accessories packages	Option																
Accessories package S01 with main switch, line contactor, EMERGENCY OFF pushbutton and safety relay, board G03, local/remote switch																	S01
Accessories package S02 with circuit breaker, line contactor, EMERGENCY OFF pushbutton and safety relay, board G03, local/remote switch																	S02
Accessories package with main switch, line contactor, board G03, local/remote switch																	S03
Accessories package with circuit breaker, line contactor, board G03, local/remote switch																	S04
Accessories package with main switch, line contactor, Calomat, RCU box connection																	S06
Bypass for smooth line synchronization (soft start function) incl. line-side main switch and contactors at the converter output and in bypass																	S08
Bypass for smooth line synchronization (soft start function) incl. line-side circuit breaker and contactors at the converter output and in bypass																	S09
Accessories package S11 with line-side main switch, board G03, local/remote switch																	S11
Accessories package S12 with line-side circuit breaker, board G03, local/remote switch																	S12
Bypass with line-side main switch, contactors at converter output and in bypass, switchover between manual and automatic, local/remote switch																	S21
Bypass with line-side circuit breaker, contactors at converter output and in bypass, switchover between manual and automatic, local/remote switch																	S22
Bypass with line-side main switch, contactors at converter output and in bypass, EMERGENCY OFF safety relay, switchover between manual and automatic, local/remote switch																	S23
Bypass with line-side circuit breaker, contactors at converter output and in bypass, EMERGENCY OFF safety relay, switchover between manual and automatic, local/remote switch																	S24
NAMUR accessories package with Test/Normal operation switch, option G05, terminal strip compliant with NAMUR NE37 (without main switch)																	S31
NAMUR accessories package with Test/Normal operation switch, main switch, line contactor, option G05, terminal strip compliant with NAMUR NE37																	S32
Option description																	
4-line display in the door	✓	✓	✓	✓	✓	✓	✓	✓	✓	✓	✓	✓	✓	✓	✓	✓	✓
Main switch as switch disconnecter incl. lockable door handle (for input current > 125 A also with short-circuit release)	✓				✓			✓			✓			✓		✓	✓
Circuit breaker with adjustable overcurrent release and short-circuit release incl. lockable door handle				✓		✓		✓		✓			✓			✓	
Main contactor on input for safety-related line disconnection	✓													✓	✓	✓	✓
EMERGENCY OFF safety relay according to EN ISO 13849-1 or SIL 1 ¹⁾ according to EN 61508	✓		✓	✓												✓	✓
EMERGENCY OFF pushbutton and EMERGENCY OFF reset in the cabinet door	✓		✓	✓												✓	✓
Selector switch for local/remote operation in the cabinet door			✓	✓	✓	✓	✓	✓	✓	✓	✓	✓	✓	✓	✓	✓	✓
Output-side converter contactor			✓	✓	✓	✓				✓	✓						
Bypass contactor			✓	✓	✓	✓				✓	✓						
Hardware for line voltage measurement and synchronizer via the converter										✓	✓						
Input-side disconnection possibility for the converter	✓		✓	✓	✓	✓							✓	✓	✓		
Motor monitoring also in bypass mode			✓	✓	✓	✓											
Manual or automatic bypass switchover			✓	✓	✓	✓											
Button "Bypass On" with lamp "Bypass On"			✓	✓	✓	✓											
Button "Bypass Off"			✓	✓	✓	✓											
Button "Reset motor fault" with lamp "Motor fault"			✓	✓	✓	✓											
Terminal strip in accordance with NAMUR recommendation NE37	✓	✓															
Selector switch for Test/Normal operation in the cabinet	✓	✓															
Peripheral board 2 (G03) incl. ATEX-certified PTC input (G03)									✓	✓	✓	✓		✓	✓	✓	✓
Peripheral board 4 (G05) incl. automatic supply disconnection, executed in accordance with EN ISO 13849-1 up to Cat. 3 and ATEX-certified PTC input	✓	✓															

1) SIL 2 available with option G08, SIL 3 on request.

SINAMICS G180

Option descriptions

Standard options

Options (continued)

S41 Main switch integrated into compact unit (might alter dimensions of unit)

With option **S41** compact units can be optionally fitted with a main switch as a switch disconnector. The handle can be operated and locked from the outside.

G08 Peripheral board 4 (**G05**) instead of peripheral board 2 (**G03**) (only in combination with package **S01, S02, S03, S04, S08, S09, S11, S12**)

T01 and Y33

Label for plant identification



T01 Example of a label

T01 Cabinet designation TAG/ITEM number according to ordering data

Resopal labels (white with black lettering) for identifying the converter are available. The labels are screwed onto the cabinet door. Please specify the TAG/ITEM number in the order.

Dimensions 450 × 300 mm max.

Y33 Customized labels

The converter cabinets are labeled with customer-specific text (e.g. "Pump No. 1").

The text and number of labels must be specified in plain text. The labels are supplied as standard in Resopal with black lettering on a white background. The labels are screwed onto the cabinet door.

Dimensions 450 × 300 mm max.

T23, T24, T25, T26, T58, T60, T74, T76, T82, T85 and T86 Converter display language (language 1/language 2)

Different languages are available for the 4-line converter display of the SINAMICS G180. Two languages can be parameterized via the IMS. The language is switched on the display under the menu item "P-EXTRAS/Language" or by pressing down the button S for 2 seconds.



T74 Example: German display/**T76** English display

Option Description

T23 Display language Norwegian/English

T24 Display language Swedish/English

T25 Display language Czech/English

T26 Display language Hungarian/English

T58 Display language French/English

T60 Display language Spanish/English

T74 Display language German/English

T76 Display language English/German

T82 Display language Portuguese/English

T85 Display language Russian/English

T86 Display language Polish/English

U04

Gost-R certificate

With option **U04** a converter design is supplied with Gost conformity.

A Gost-R certificate is not generally required for frequency converters. A Gost-R negative certificate is issued as standard for a SINAMICS G180 to be exported to Russia. This confirms that the product is not subject to mandatory Gost-R certification.

Voluntary certification (Gost-R certificate) is, however, recommended for the following reasons:

- It simplifies customs clearance
- Certification on a voluntary basis increases the sales opportunities on the Russian market, because the consumer trusts certified goods.
- Voluntary certification is required in some cases on the Russian market (in retail, construction industry, etc.).
- Accredited certification bodies guarantee, with their signatures, conformity of the certified goods with Russian standards.
- An attested and signed copy of the Gost-R certificate must be presented for every delivery to the Russian federation for customs clearance. It is also required for subsequent sales/marketing within the country.

Options (continued)

H80, H81, H82, H83, H84, H85 and H86
Cabinet widths for cabinet systems with compact units

Option	Description
H80	Cabinet width: 406 mm
H81	Cabinet width: 606 mm
H82	Cabinet width: 806 mm
H83	Cabinet width: 1006 mm
H84	Cabinet width: 1206 mm
H85	Cabinet width: 1406 mm
H86	Cabinet width: 1606 mm

H90, H91, H92, H93 and H94
Additional cabinets for cabinet units

Option	Description
H90	Additional cabinet: 400 mm
H91	Additional cabinet: 600 mm
H92	Additional cabinet: 800 mm
H93	Additional cabinet: 1000 mm
H94	Additional cabinet: 1200 mm

V61, V62 and V63
Ambient temperature for air-cooled converters

The maximum permissible coolant temperature is 40 °C for air-cooled units. If operation is required with higher coolant temperatures, derating is necessary.

Option	Description
V61	45 °C ambient temperature (with corresponding derating)
V62	50 °C ambient temperature (with corresponding derating)
V63	55 °C ambient temperature (for compact units with corresponding derating)

V66, V67 and V68
Water inlet temperature for liquid-cooled converters

The maximum permissible water inlet temperature is between 28 and 35 °C depending on the converter type (see technical data for maximum cooling water temperature). If operation is required with higher coolant temperatures, derating is necessary.

Option	Description
V66	30 °C water inlet temperature (with corresponding derating)
V67	35 °C water inlet temperature (with corresponding derating)
V68	40 °C water inlet temperature (with corresponding derating)

V86, V87, V88 and V89
Installation altitude

At an installation altitude for the SINAMICS G180 of over 1000 m above sea level, reduced cooling caused by the lower air pressure and cosmic radiation means that the input voltage must be reduced (see the section "Characteristic curves" under "Configuring instructions"). Options **V86** to **V89** specify the installation altitude of the converter.

Option	Description
V86	Installation altitude max. 1500 m above sea level (with corresponding derating)
V87	Installation altitude max. 2000 m above sea level (with corresponding derating)
V88	Installation altitude max. 2500 m above sea level (with corresponding derating)
V89	Installation altitude max. 3000 m above sea level (with corresponding derating)

V70, V71, V72, V73, V74, V75, V76, V77, V78, V79, V80 and Y70
Line voltages

Options V70 to Y70 are used to select the line voltage. These options mutually exclude each other.

Option	Description
V70	Line voltage 380 V, 50 Hz
V71	Line voltage 400 V, 50 Hz
V72	Line voltage 415 V, 50 Hz
V73	Line voltage 500 V, 50 Hz
V74	Line voltage 660 V, 50 Hz
V75	Line voltage 690 V, 50 Hz
V76	Line voltage 440 V, 60 Hz
V77	Line voltage 460 V, 60 Hz
V78	Line voltage 480 V, 60 Hz
V79	Line voltage 600 V, 60 Hz
V80	Line voltage 660 V, 60 Hz
Y70	Special line voltage; please specify voltage

Y13
Language of manual
Y13 Different languages for manual

The following languages are available for the manual:

- Bulgarian
- Czech
- German
- English
- Spanish
- French
- Dutch
- Polish
- Russian
- Norwegian

Note:
Other languages on request.

SINAMICS G180

Option descriptions

Inspection options

Options

F71 to F73 and F80 to F85 **Inspections for converters**



Endurance run test bays up to 270 kW in Siemens Ruhstorf factory

In general, every converter that leaves the factory is subjected to a routine test under load conditions. The converter is therefore preparameterized. This assures the high quality standards of every SINAMICS G180 converter. Options **F71** to **F73** and **F80** to **F85** also allow further tests to be performed, also with the customer present.

Options for inspections mutually exclude each other.

Inspections for converters	Option								
Routine test under no-load conditions with the customer present									F71
Routine test with 1PS or 1MD motor (ordered with converter in package), under no-load conditions (without customer present)									F72
Routine test with 1PS or 1MD motor (ordered with converter in package), under no-load conditions with customer present									F73
Visual inspection and function test under rated load using test bay motor (without customer present)									F80
Visual inspection and function test under rated load using test bay motor with customer present									F81
Visual inspection and function test under rated load with 1PS or 1MD motor (ordered with converter in package) (without customer present)									F82
Visual inspection and function test under rated load with 1PS or 1MD motor (ordered with converter in package) with customer present									F83
Advanced visual inspection and function test under rated load with 1PS or 1MD motor (ordered with converter in package) (without customer present)									F84
Advanced visual inspection and function test under rated load with 1PS or 1MD motor (ordered with converter in package) with customer present									F85
Option description									
• Check of the mechanical system and the touch protection	✓	✓	✓	✓	✓	✓	✓	✓	✓
• Check for completeness									
• Check of equipment (components)									
• Check of cables									
• Check of customer documentation									
• Check of power supply									
• Check of fans									
• Check of equipment identifier									
• Precharging test									
• Function check of the converter control									
• Function check of protective and monitoring devices (simulation)									
• Function check of the customized control									
Measurement of shaft voltage, vibration and audible noises at no load on the motor	✓	✓						✓	✓
Measurement of the output of the converter (efficiency, power factor)	✓	✓	✓	✓	✓	✓			
Measurement of the output at the motor (efficiency, power factor)	✓	✓	✓	✓	✓	✓			
Harmonic analysis of line and motor current at the test bay motor	✓	✓	✓	✓	✓	✓			
Warm-up at the drive's rated operating point	✓	✓	✓	✓	✓	✓			
Temperature measurement on the converter	✓	✓	✓	✓	✓	✓			
Temperature measurement on the motor	✓	✓	✓	✓					
Temperature measurement on LOHER 1PS or 1MD motor	✓	✓							
Special tests under full-load conditions:	✓	✓							
• Single-phase interruption of the motor infeed									
• Single-phase interruption of the converter infeed									
• Ground fault at converter output									
Special tests in no-load operation:	✓	✓							
• Two-phase short-circuit at the motor terminals									
Submission of the inspection report	✓		✓		✓		✓		✓
With customer present	✓		✓		✓		✓		✓

Options (continued)Note:

If the layout of the test bay permits, for an additional charge the test can be performed using a transformer or with the original motor of another manufacturer which has been provided by the customer.

The scope of the test following inspection **F72** or **F73** corresponds to the routine test for oil & gas projects according to DEP (Design and Engineering Practice) 33.66.05.33-GEN, Feb. 2012, Section 15.2.

The scope of the test following inspection **F84** or **F85** corresponds to the performance test for oil & gas projects according to DEP (Design and Engineering Practice) 33.66.05.33-GEN, Feb. 2012, Section 15.1.

We can offer further tests on request that are not included in the respective inspections at an additional charge. It is important to note that if the scope of the tests change, the prices for the individual inspections can change significantly, which is why we request prior consultation with the factory.

SINAMICS G180

Option descriptions

Engineer To Order – ETO

Options

Engineering

In addition to the standard options, for SINAMICS G180 converters, the option "Engineer To Order" (ETO) can also be ordered. These ETO orders are then specially defined and engineered to suit customer requirements. They cannot be ordered using the electronic ordering tools, but only on request through a Siemens contact:

X30 mechanical

e.g. cabinet dimensions with special height = 1800 mm

X40 parameterization

e.g. parameterization of additional monitoring functions: overspeed, underspeed

X50 electrical (output, controller)

e.g. special monitoring devices, safety-related standstill monitoring of motor speed

X51 extended overvoltage range

- For compact units:
 - 400 V supply with 400 V compact units:
These converters can be operated up to 500 V + 10 % as standard. These converters are therefore suitable as standard for ZLU use. If the overvoltage has been agreed as $1.4 \times U_r$, the parameter UD-MAXFAKT simply has to be set to 140 %.
 - 500 V supply with 500 V compact units:
The 690 V devices must be selected for this purpose. The power rating must normally then be increased to the next level. The parameter U mains nom. must be set to 500 V. UD-MAXFAKT must be set to the agreed value (125 to 140 %).
 - 690 V supply with 690 V compact units:
These devices can be operated for a short time at an overvoltage of $1.3 \times U_r$.
- For cabinet units:
 - 400 V supply with cabinet units:
The 500 V devices must be selected for this purpose. The power rating must normally then be increased to the next level. The parameter U mains nom. must be set to 400 V. UD-MAXFAKT must be set to the agreed value (125 to 140 %).
 - 500 V supply with 500 V cabinet units:
The 690 V devices must be selected for this purpose. The power rating must normally then be increased to the next level. The parameter U mains nom. must be set to 500 V. UD-MAXFAKT must be set to the agreed value (125 to 140 %).
 - 690 V supply with 690 V cabinet units up to 710 kW:
These devices can be operated for a short time at an overvoltage of $1.3 \times U_r$.
 - 690 V supply with 690 V cabinet units from 800 to 1000 kW:
This converter output is achieved by interconnecting converters with lower outputs (multi-system converter). The devices can then be operated for a short time at an overvoltage of $1.3 \times U_r$.

More detailed information can be obtained from your Siemens sales partner.

X60 test bay converter

e.g. engineering of a motor test bay

X70 special tests

e.g. special tests, such as vibration

X80 special documentation

e.g. documentation in a special CAD system

X90 special version

When the scope cannot be clearly assigned to one of the already listed options.

Configuring instructions



5/2 Functions

- 5/2 [Overview](#)
- 5/2 Communication with higher-level control and customer terminal strip
- 5/2 Open-loop and closed-loop control functions
- 5/2 Software and protective functions
- 5/3 Safety Integrated functions

5/5 Characteristic curves

- 5/5 [Overview](#)
- 5/5 Derating data
- 5/7 Overload capability

5/8 Cable cross-sections and connections

- 5/8 [Overview](#)
- 5/14 Converter connection for different pulse numbers
- 5/14 Required cable cross-sections for line and motor connections
- 5/15 Grounding and PE conductor cross-section

5/16 Standard interface

- 5/16 [Overview](#)
- 5/17 Standard assignment of inputs/outputs
- 5/17 NAMUR-compliant assignment of inputs/outputs

5/18 Communication possibilities

- 5/18 [Overview](#)
- 5/18 Operating principle

5/19 The SINAMICS G180 type plate

- 5/19 [Overview](#)

5/20 ZLU – Supplementary Supply Agreements for Converter Drives in Power Plants

- 5/20 [Overview](#)

5/21 SIZER for Siemens Drives engineering tool

- 5/21 [Overview](#)
- 5/21 System requirements
- 5/21 [Selection and ordering data](#)
- 5/21 [More information](#)

5/22 DT Configurator selection guide

- 5/22 [Overview](#)
- 5/22 Product description
- 5/23 Product range
- 5/23 System requirements
- 5/23 Offline access in the Interactive Catalog CA 01
- 5/23 Online access in the Siemens Mall
- 5/23 [Selection and ordering data](#)
- 5/23 [More information](#)

5/24 IMS commissioning tool

- 5/24 [Overview](#)
- 5/24 Functions
- 5/24 [Integration](#)
- 5/25 [Selection and ordering data](#)
- 5/25 [Accessories](#)
- 5/25 [More information](#)

SINAMICS G180

Configuring instructions

Functions

Overview

Communication with higher-level control and customer terminal strip

A terminal strip compliant with NAMUR recommendation NE37 is provided as standard for the customer interface. Ethernet (PROFIBUS with Ethernet-to-PROFIBUS converter board), PROFIBUS DP, Modbus RTU, Modbus TCP and CANopen interfaces are also available. A PROFINET-based communication option is currently in development.

The NAMUR-compliant customer terminal strip can be used to connect the converter to the higher-level controller using analog and digital signals, or to connect additional units.

To simplify configuring and commissioning of the drive, various applications can be selected and modified in the frequency converter. The unit can also be parameterized individually at the factory prior to delivery.

Further information and guidance are available in the IMS.

Software and protective functions

The software functions available as standard are described below:

Software and protective functions	Description
Setpoint inputs	Setpoints can be input both internally and externally, i.e. internally as a fixed setpoint or motorized potentiometer setpoint and externally via the communications interface or an analog input on the customer terminal strip. The internal fixed setpoint and the motorized potentiometer setpoint can be switched over or adjusted using control commands via all interfaces.
Autotuning function	Thanks to the autotuning function (automatic measurement of the motor stator resistance), the closed-loop drive control can be commissioned and optimized faster and more easily.
Random pattern	Pulse pattern generation with or without random pattern can be selected. The purpose of this function is to prevent dominant clock frequency noise in the motor.
Ramp-function generator	A convenient ramp-function generator with separately adjustable and switchable ramping times, together with adjustable and switchable rounding times in the lower and upper speed ranges (transition roundings 1 to 4), allows the drive to be smoothly accelerated and braked. As a consequence, this avoids the drive train from being overloaded and reduces the stress on mechanical components. The down ramps can be parameterized separately for quick stop. In addition, all parameters can be switched over for special operating ranges.
Overvoltage controller	The overvoltage limiting controller automatically prevents overvoltages in the DC link if the down ramp is too short, for example. This may also extend the set ramp-down time.
Mains supply backup	In the event of supply voltage dips, the kinetic energy of the rotating drive is used to buffer the DC link so as to prevent fault trips. The converter remains operational as long as the drive can provide regenerative energy as a result of its motion and the DC link voltage does not drop below the trip threshold. When the line supply recovers within a parameterizable time, the drive is again accelerated up to its setpoint speed.
Undervoltage behavior	The operational performance of the frequency converter under line undervoltage conditions can be influenced to a large extent. The automatic restart function switches the drive on again when the power is restored after a power failure, and ramps up to the current speed setpoint. The automatic restart function is successful only if the power failure does not last longer than the parameterized T restart time.
Synchronization	It is possible to synchronize the SINAMICS G180 converter with a motor that is still turning and to accelerate the motor to the specified setpoint.
Slip compensation	An automatic slip compensation function improves the speed accuracy of drives that are not equipped with a speed encoder.
Process control	The integrated process controller can be used to implement simple control functions, e.g. level control or volumetric flow control. It is designed as a PID controller with separately settable P, I and D components.
Logic elements	The "Logic elements" function can be used to generate modal signals and to combine signals using logic.
Message generators	Messages can be generated subject to predefined conditions.
Parameter switches	A parameter switch can be used to switch a parameter from its original value to an alternative value.
Automatic acknowledgement function	Fault messages can be acknowledged fully automatically if required.

Open-loop and closed-loop control functions

The SINAMICS G180 converter can be operated in different control modes:

- Closed-loop control of the speed or torque of a drive by appropriate machine commutation. In "space-vector control" mode (SVC), the converter utilizes an optimized voltage/frequency ratio. To meet the requirements of dynamic applications, machine commutation can be combined with a tachogenerator to implement "field-oriented control" (FOC).
- Closed-loop control of current or voltage at the converter output. This mode of control does not involve machine commutation. The output frequency and the current or the voltage are specified as setpoints and implemented in the converter (within the tolerances of the unit).

Thanks to the integrated process controller, it is possible to control a wide range of process variables in different control modes.

Overview (continued)

Software and protective functions	Description
Display	The bilingual, four-line graphical display with membrane keyboard on the converter shows operational messages, alarms and fault messages in plain text. The converter can be operated locally by means of this display.
Event memory	A comprehensive memory function for storing the last 64 events, including actual values recorded prior to and during each event, aids the evaluation and analysis of faults.
Time synchronization and operating hours counters	Timing functions can be synchronized with an external clock via digital inputs. Two different counters, one for frequency converter operating hours and the other for fan operating hours, can supply important information to the service engineer.
Motor protection	Motor protection through evaluation of a KTY84, PTC or Pt100 temperature sensor. When a KTY84 sensor is connected, the limit values can be set for alarm or shutdown. When a PTC thermistor is connected, the system reaction to triggering of the thermistor (alarm or shutdown) can be defined.
Motor blocking protection	A blocked motor is detected and can be protected against thermal overloading by a fault trip.
Noise reduction	Optimization of the pulse pattern can minimize motor noise emissions and also reduce motor losses.
Brake optimization	An oversaturation control system is provided to ensure optimum braking performance without the need for any additional equipment. A parameterizable DC braking function is also provided to permit precise deceleration down to zero speed.
Operational reliability	In order to ensure smooth reliable operation, the converter is equipped with an automatic overload time adaptation function and stall protection implemented by a tried-and-tested current limitation control system.
Fault detection	Automatic monitoring for irregularities in operation, e.g. overspeed, underspeed or no-load. These conditions can be detected and signaled by appropriate alarms.
Fault suppression	Fault messages and fault trips initiated by fault messages can be suppressed (e.g. for smoke extraction motors).
Power unit protection	
Ground fault monitoring at output end	A ground fault at the output end is detected by a total current monitor and results in shutdown in grounded-neutral systems.
Insulation monitoring	The insulation can be monitored for ground faults on converters operating on a non-grounded power supply system.
Current asymmetry monitoring at output end	A current symmetry monitoring system detects hazardous current unbalances and initiates a fault trip if necessary.
Electronic short-circuit protection at the output end	A short-circuit at the output (e.g. at the converter output terminals, in the motor cable or in the motor terminal box) is detected and the converter shuts down with "fault".
Thermal overload protection	When the overtemperature threshold monitor responds, an alarm is output initially and the clock frequency is reduced. If the temperature continues to rise, the current limit values are lowered in order to reduce the thermal load. Once the cause of the fault has been eliminated (e.g. cooling has been improved), the original operating values are automatically resumed.

Safety Integrated functions

The safety functions integrated in SINAMICS G180 converters provide highly effective application-oriented protection for personnel and machinery.

When equipped with one of the options **G04**, **G05** or **G08**, SINAMICS G180 converters provide the following Safety Integrated function (terms defined according to IEC 61800-5-2):

- Safe Torque Off (STO)

The Safety Integrated function is implemented electronically and therefore offers short response times in comparison to solutions with externally implemented monitoring functions.

Legal framework

Machine manufacturers and plant constructors must ensure that their machines or plants cannot cause danger due to malfunctions apart from the general risks of electric shock, heat or radiation. In Europe, for example, compliance with the machinery directive is legally stipulated by the EU industrial safety directive.

In order to ensure compliance with this directive, it is recommended that the corresponding harmonized European standards are applied. This initiates the assumption of conformity and gives manufacturers and operators the legal security when complying with both national regulations and EU directives. The machine manufacturer uses the CE labeling to document the compliance with all relevant directives and regulations in the free movement of goods.

Safety-related standards

Functional safety is specified in various standards.

EN ISO 12100 and EN ISO 14121-1, for example, are concerned with the design and risk assessment of machines. EN 62061 (only applicable for electrical and electronic control systems) and EN ISO 13849-1 define the functional and safety-related requirements of safety-oriented control systems.

The above-mentioned standards define different safety requirements that the machine has to satisfy in accordance with the risk, frequency of a dangerous situation, probability of occurrence and the opportunities for recognizing impending danger.

- EN ISO 13849-1: Categories B, 1 ... 4
- EN ISO 13849-1: Performance Level PL a ... e
- EN 62061: Safety Integrity Level SIL 1 ... 3

SINAMICS G180

Configuring instructions

Functions

Overview (continued)

Safety functions integrated in the drive with SINAMICS G180

The safety functions integrated in the SINAMICS G180 converter with option **G04**, **G05** or **G08** satisfy the requirements of:

- Category 3 according to EN ISO 13849-1
- Performance Level (PL) d according to EN ISO 13849-1
- Safety Integrity Level (SIL) 2 according to EN 61508

With additional option **S01**, **S02** or **S32**, the SINAMICS G180 also complies with the following:

- Safety Integrity Level (SIL) 3 according to EN 61508

In addition, the Safety Integrated functions of SINAMICS G180 are generally certified by independent institutes. An up-to-date list of currently certified components is available on request from your local Siemens office.

Detailed description of the Safety Integrated function

Safe Torque Off (STO) is a function that prevents the drive from restarting unexpectedly in accordance with EN 60204-1 Section 5.4. Safe Torque Off disables the drive pulses and disconnects the power supply to the motor (corresponds to Stop Category 0 of EN 60204-1). The drive is reliably torque-free. This state is also monitored internally in the drive.

STO has the immediate effect that the drive cannot provide any torque-generating energy. STO can be used wherever the drive will reach a standstill by itself due to the load torque or friction in a sufficiently short time or when "coasting down" of the drive will not have any relevance for safety.

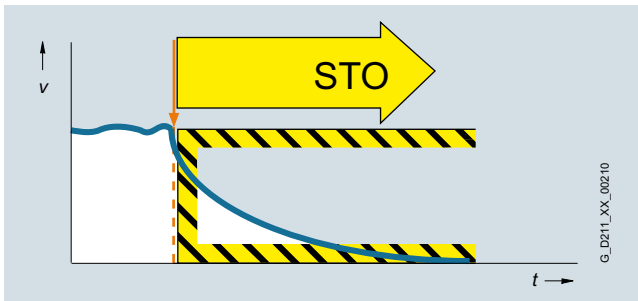

Safe Torque Off

SINAMICS G180

Configuring instructions

Characteristic curves

Overview (continued)

Derating for liquid-cooled converters with coolant inlet temperature of max. 28 °C

Installation altitude above sea level m	Current derating factor (as a % of the rated current) for a coolant inlet temperature of 28 °C				
	18 °C	23 °C	28 °C	33 °C	38 °C
0 ... 1000	100 %			84.0 %	64.2 %
1001 ... 1500	100 %			94.4 %	60.6 %
1501 ... 2000	100 %			88.9 %	57.0 %
2001 ... 2500	100 %			70.0 %	53.5 %
2501 ... 3000	94.8 %			77.8 %	49.9 %
3001 ... 3500 ¹⁾	88.5 %			73.3 %	47.1 %
3501 ... 4000 ¹⁾	83.4 %			68.9 %	44.2 %
4001 ... 4500 ¹⁾	78.4 %			64.4 %	41.4 %
4501 ... 5000 ¹⁾	73.3 %			60.0 %	38.5 %

Derating for liquid-cooled converters with coolant inlet temperature of max. 30 °C

Installation altitude above sea level m	Current derating factor (as a % of the rated current) for a coolant inlet temperature of 30 °C				
	20 °C	25 °C	30 °C	35 °C	40 °C
0 ... 1000	100 %			81.6 %	57.7 %
1001 ... 1500	100 %			77.1 %	54.5 %
1501 ... 2000	100 %			72.6 %	51.3 %
2001 ... 2500	96.2 %			68.0 %	48.1 %
2501 ... 3000	89.8 %			63.5 %	44.9 %
3001 ... 3500 ¹⁾	84.7 %			59.9 %	42.3 %
3501 ... 4000 ¹⁾	79.5 %			56.2 %	39.8 %
4001 ... 4500 ¹⁾	74.4 %			52.6 %	37.2 %
4501 ... 5000 ¹⁾	69.3 %			49.0 %	34.6 %

Derating for liquid-cooled converters with coolant inlet temperature of max. 35 °C

Installation altitude above sea level m	Current derating factor (as a % of the rated current) for a coolant inlet temperature of 35 °C			
	25 °C	30 °C	35 °C	40 °C
0 ... 1000	100 %			70.7 %
1001 ... 1500	100 %			66.8 %
1501 ... 2000	100 %			62.9 %
2001 ... 2500	100 %			58.9 %
2501 ... 3000	95.3 %			55.0 %
3001 ... 3500 ¹⁾	89.8 %			51.9 %
3501 ... 4000 ¹⁾	84.4 %			48.7 %
4001 ... 4500 ¹⁾	78.9 %			45.6 %
4501 ... 5000 ¹⁾	73.5 %			42.4 %

The compact units are designed according to minimum air clearances at up to 2000 m above sea level, and the cabinet units according to minimum air clearances at up to 3000 m above sea level, i.e. voltage derating is not required for compact units at altitudes of 2000 m or below or for cabinet units at altitudes of 3000 m or below.

Since the air clearances in the converter cannot be changed, this factor must be taken into account in the voltage derating calculation. V_{\max} is the reference value for voltage derating.

Voltage derating factor

Installation altitude above sea level m	For compact units and cabinet systems: Voltage derating factor (in % of line voltage)	For cabinet units: Voltage derating factor (in % of line voltage)
	<ul style="list-style-type: none"> • For 400 V units $\Rightarrow V_{\max} = 500$ V • For 500 V units $\Rightarrow V_{\max} = 500$ V • For 690 V units $\Rightarrow V_{\max} = 690$ V 	<ul style="list-style-type: none"> • For 400 V units $\Rightarrow V_{\max} = 415$ V • For 500 V units $\Rightarrow V_{\max} = 500$ V • For 690 V units $\Rightarrow V_{\max} = 690$ V
0 ... 2000	100 %	
2001 ... 2500	93.4 %	100 %
2501 ... 3000	87.7 %	100 %
3001 ... 3500	81.9 %	93.9 %
3501 ... 4000	77.5 %	88.5 %
4001 ... 4500	71.9 %	82.4 %
4501 ... 5000	67.6 %	77.0 %

¹⁾ Voltage derating (see voltage derating factor) is also required for cabinet units at an installation altitude of > 3000 m.

Overview (continued)

Overload capability

The SINAMICS G180 converters have an overload reserve of typically about 110 % to deal with breakaway torques, for example. The overload period of the potential short-time current is regulated automatically (thermal converter model), but is at least 60 s at 40 °C on condition that the converter is operated at its rated current prior to and following the period of overload. This calculation is based on a duty cycle duration of 600 s.

If larger surge loads occur, this must be taken into account when configuring. It may be necessary to select a converter in the next-higher rating class.

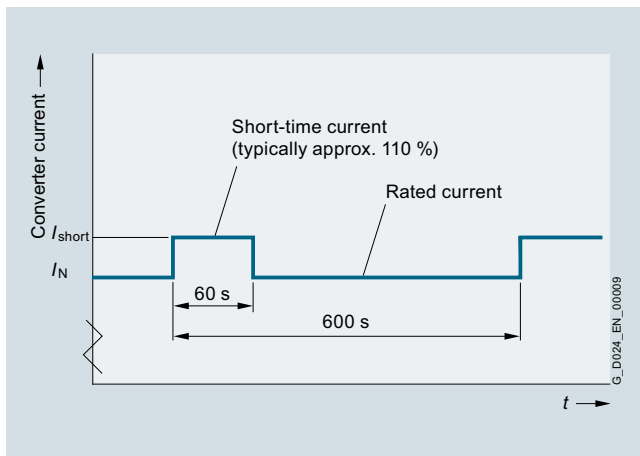

Overload capability of SINAMICS G180

SINAMICS G180

Configuring instructions

Cable cross-sections and connections

Overview

Type rating	Converter	Converter type	Line connection (standard)			Line connection with main switch or circuit breaker (Options: S01, S02, S03, S04, S06, S08, S09, S11, S12, S21, S22, S23, S24, S41)			Motor connection		
			Cable cross-section solid/stranded		Fixing	Cable cross-section solid/stranded		Fixing	Cable cross-section solid/stranded		Fixing
kW	SINAMICS G180		min.	max.		min.	max.		min.	max.	
			IEC	IEC		IEC	IEC		IEC	IEC	
			mm ²	mm ²		mm ²	mm ²		mm ²	mm ²	
SINAMICS G180 compact unit 400 V 6-pulse (230 to 500 V 3 AC TN/TT system, 50 to 60 Hz)											
2.2	6SE0100-1AC15-5..A7	2T2A-07400-002	0.2	6	Terminal	1	16	Terminal	0.2	6	Terminal
3	6SE0100-1AC17-0..A7	2T2A-07400-003	0.2	6	Terminal	1	16	Terminal	0.2	6	Terminal
4	6SE0100-1AC21-0..A7	2T2A-07400-004	0.2	6	Terminal	1	16	Terminal	0.2	6	Terminal
5.5	6SE0100-1AC21-3..A7	2T2A-07400-005	0.2	6	Terminal	1	16	Terminal	0.2	6	Terminal
7.5	6SE0100-1AC21-8..A7	2T2A-07400-007	4	16	Terminal	1	16	Terminal	4	16	Terminal
11	6SE0100-1AC22-5..A7	2T2A-07400-011	4	16	Terminal	1	16	Terminal	4	16	Terminal
15	6SE0100-1AC23-7..A7	2T2A-07400-015	0.75	35	Terminal	2.5	35	Terminal	0.75	35	Terminal
22	6SE0100-1AC24-8..A7	2T2A-07400-022	0.75	35	Terminal	2.5	35	Terminal	0.75	35	Terminal
30	6SE0100-1AC25-8..A7	2T2A-07400-030	0.75	35	Terminal	2.5	35	Terminal	0.75	35	Terminal
37	6SE0100-1AC27-8..A7	2T2A-07400-037	2.5	120	1 × M8	2.5	95	Terminal	2.5	120	1 × M8
45	6SE0100-1AC28-8..A7	2T2A-07400-045	2.5	120	1 × M8	2.5	95	Terminal	2.5	120	1 × M8
55	6SE0100-1AC31-1..A7	2T2A-07400-055	2.5	120	1 × M8	2.5	95	Kemme	2.5	120	1 × M8
75	6SE0100-1AC31-5..A7	2T2A-07400-075	2.5	120	1 × M8	2.5	95	Kemme	2.5	120	1 × M8
90	6SE0100-1AC31-8..A7	2T2A-07400-090	2.5	120	1 × M8	2.5	150	Terminal	2.5	120	1 × M8
110	6SE0100-1AC32-1..A7	2T2A-07400-110	2.5	120	1 × M8	2.5	150	Terminal	2.5	120	1 × M8
132	6SE0100-1AC32-5..A7	2T2A-07400-132	2 × 6	2 × 240	1 × M10				2 × 6	2 × 240	1 × M10
160	6SE0100-1AC33-0..A7	2T2A-07400-160	2 × 6	2 × 240	1 × M10				2 × 6	2 × 240	1 × M10
SINAMICS G180 compact unit 500 V 6-pulse (230 to 500 V 3 AC IT system, 50 to 60 Hz)											
2.2	6SE0100-1AD14-5..A7	2T2A-07500-002	0.2	6	Terminal	1	16	Terminal	0.2	6	Terminal
3	6SE0100-1AD15-5..A7	2T2A-07500-003	0.2	6	Terminal	1	16	Terminal	0.2	6	Terminal
4	6SE0100-1AD17-0..A7	2T2A-07500-004	0.2	6	Terminal	1	16	Terminal	0.2	6	Terminal
5.5	6SE0100-1AD21-0..A7	2T2A-07500-005	0.2	6	Terminal	1	16	Terminal	0.2	6	Terminal
7.5	6SE0100-1AD21-3..A7	2T2A-07500-007	0.2	6	Terminal	1	16	Terminal	0.2	6	Terminal
11	6SE0100-1AD21-8..A7	2T2A-07500-011	4	16	Terminal	1	16	Terminal	4	16	Terminal
15	6SE0100-1AD22-5..A7	2T2A-07500-015	4	16	Terminal	1	16	Terminal	4	16	Terminal
22	6SE0100-1AD23-7..A7	2T2A-07500-022	0.75	35	Terminal	2.5	35	Terminal	0.75	35	Terminal
30	6SE0100-1AD24-8..A7	2T2A-07500-030	0.75	35	Terminal	2.5	35	Terminal	0.75	35	Terminal
37	6SE0100-1AD25-8..A7	2T2A-07500-037	0.75	35	Terminal	2.5	35	Terminal	0.75	35	Terminal
45	6SE0100-1AD27-8..A7	2T2A-07500-045	2.5	120	1 × M8	2.5	95	Terminal	2.5	120	1 × M8
55	6SE0100-1AD28-8..A7	2T2A-07500-055	2.5	120	1 × M8	2.5	95	Terminal	2.5	120	1 × M8
75	6SE0100-1AD31-1..A7	2T2A-07500-075	2.5	120	1 × M8	2.5	95	Kemme	2.5	120	1 × M8
90	6SE0100-1AD31-5..A7	2T2A-07500-090	2.5	120	1 × M8	2.5	95	Kemme	2.5	120	1 × M8
110	6SE0100-1AD31-8..A7	2T2A-07500-110	2.5	120	1 × M8	2.5	150	Terminal	2.5	120	1 × M8
132	6SE0100-1AD32-1..A7	2T2A-07500-132	2.5	120	1 × M8	2.5	150	Terminal	2.5	120	1 × M8
160	6SE0100-1AD32-5..A7	2T2A-07500-160	2 × 6	2 × 240	1 × M10				2 × 6	2 × 240	1 × M10
200	6SE0100-1AD33-0..A7	2T2A-07500-200	2 × 6	2 × 240	1 × M10				2 × 6	2 × 240	1 × M10
SINAMICS G180 compact unit 690 V 6-pulse (230 to 600¹⁾/690 V 3 AC TN/TT or IT system, 50 to 60 Hz)											
7.5	6SE0100-1A..21-0..A7	2T2A-07600-007	4	16	Terminal	1	16	Terminal	4	16	Terminal
11	6SE0100-1A..21-3..A7	2T2A-07600-011	4	16	Terminal	1	16	Terminal	4	16	Terminal
15	6SE0100-1A..21-8..A7	2T2A-07600-015	4	16	Terminal	1	16	Terminal	4	16	Terminal
22	6SE0100-1A..22-5..A7	2T2A-07600-022	4	16	Terminal	1	16	Terminal	4	16	Terminal
30	6SE0100-1A..23-4..A7	2T2A-07600-030	2.5	120	1 × M8	2.5	35	Terminal	2.5	120	1 × M8
37	6SE0100-1A..24-2..A7	2T2A-07600-037	2.5	120	1 × M8	2.5	35	Terminal	2.5	120	1 × M8
45	6SE0100-1A..25-0..A7	2T2A-07600-045	2.5	120	1 × M8	2.5	35	Terminal	2.5	120	1 × M8
55	6SE0100-1A..25-8..A7	2T2A-07600-055	2.5	120	1 × M8	2.5	95	Terminal	2.5	120	1 × M8
75	6SE0100-1A..28-0..A7	2T2A-07600-075	2.5	120	1 × M8	2.5	95	Terminal	2.5	120	1 × M8
90	6SE0100-1A..31-0..A7	2T2A-07600-090	2.5	120	1 × M8	2.5	95	Terminal	2.5	120	1 × M8
110	6SE0100-1A..31-2..A7	2T2A-07600-110	2.5	120	1 × M8	2.5	95	Terminal	2.5	120	1 × M8
132	6SE0100-1A..31-4..A7	2T2A-07600-132	2.5	120	1 × M8	2.5	150	Terminal	2.5	120	1 × M8
160	6SE0100-1A..31-7..A7	2T2A-07600-160	2 × 6	2 × 240	1 × M10				2 × 6	2 × 240	1 × M10
200	6SE0100-1A..32-1..A7	2T2A-07600-200	2 × 6	2 × 240	1 × M10				2 × 6	2 × 240	1 × M10

¹⁾ With an NRTL unit ("U" in 14th position of article number), the voltage range ends at max. 600 V, otherwise at 690 V.

Overview (continued)

Type rating	Converter	Converter type	Line connection (standard)			Line connection with main switch or circuit breaker (Options: S01, S02, S03, S04, S06, S08, S09, S11, S12, S21, S22, S23, S24, S41)			Motor connection		
			Cable cross-section solid/stranded		Fixing	Cable cross-section solid/stranded		Fixing	Cable cross-section solid/stranded		Fixing
kW	SINAMICS G180		min.	max.		min.	max.		min.	max.	
			IEC	IEC		IEC	IEC		IEC	IEC	
			mm ²	mm ²		mm ²	mm ²		mm ²	mm ²	
SINAMICS G180 cabinet system 400 V 6-pulse (230 to 500 V 3 AC TN/TT system, 50 to 60 Hz)											
2.2	6SE0140-1.C15-5.A7	2X.A-8740.-002	0.5	10	Terminal	0.5	10	Terminal	0.5	10	Terminal
3	6SE0140-1.C17-0.A7	2X.A-8740.-003	0.5	10	Terminal	0.5	10	Terminal	0.5	10	Terminal
4	6SE0140-1.C21-0.A7	2X.A-8740.-004	0.5	10	Terminal	0.5	10	Terminal	0.5	10	Terminal
5.5	6SE0140-1.C21-3.A7	2X.A-8740.-005	0.5	10	Terminal	0.5	10	Terminal	0.5	10	Terminal
7.5	6SE0140-1.C21-8.A7	2X.A-8740.-007	4	16	Terminal	4	16	Terminal	4	16	Terminal
11	6SE0140-1.C22-5.A7	2X.A-8740.-011	4	16	Terminal	4	16	Terminal	4	16	Terminal
15	6SE0140-1.C23-7.A7	2X.A-8740.-015	0.75	35	Terminal	0.75	35	Terminal	0.75	35	Terminal
22	6SE0140-1.C24-8.A7	2X.A-8740.-022	0.75	35	Terminal	0.75	35	Terminal	0.75	35	Terminal
30	6SE0140-1.C25-8.A7	2X.A-8740.-030	0.75	35	Terminal	0.75	35	Terminal	0.75	35	Terminal
37	6SE0140-1.C27-8.A7	2X.A-8740.-037	2 × 6	2 × 240	1 × M10	2 × 6	2 × 240	1 × M10	2 × 6	2 × 240	1 × M10
45	6SE0140-1.C28-8.A7	2X.A-8740.-045	2 × 6	2 × 240	1 × M10	2 × 6	2 × 240	1 × M10	2 × 6	2 × 240	1 × M10
55	6SE0140-1.C31-1.A7	2X.A-8740.-055	2 × 6	2 × 240	1 × M10	2 × 6	2 × 240	1 × M10	2 × 6	2 × 240	1 × M10
75	6SE0140-1.C31-5.A7	2X.A-8740.-075	2 × 6	2 × 300	1 × M10	2 × 2.5	2 × 150	1 × M6	2 × 6	2 × 300	1 × M10
90	6SE0140-1.C31-8.A7	2X.A-8740.-090	2 × 6	2 × 300	1 × M10	2 × 6	2 × 185	1 × M10	2 × 6	2 × 300	1 × M10
110	6SE0140-1.C32-1.A7	2X.A-8740.-110	2 × 6	2 × 300	1 × M10	2 × 6	2 × 185	1 × M10	2 × 6	2 × 300	1 × M10
132	6SE0140-1.C32-5.A7	2X.A-8740.-132	2 × 6	2 × 300	1 × M10	2 × 6	2 × 185	1 × M10	2 × 6	2 × 300	1 × M10
160	6SE0140-1.C33-0.A7	2X.A-8740.-160	2 × 6	2 × 300	1 × M10	2 × 6	2 × 300	1 × M10	2 × 6	2 × 300	1 × M10
SINAMICS G180 cabinet systems 500 V 6-pulse (230 to 500 V 3 AC IT system, 50 to 60 Hz)											
2.2	6SE0140-1.D14-5.A7	2X.A-8750.-002	0.5	10	Terminal	0.5	10	Terminal	0.5	10	Terminal
3	6SE0140-1.D15-5.A7	2X.A-8750.-003	0.5	10	Terminal	0.5	10	Terminal	0.5	10	Terminal
4	6SE0140-1.D17-0.A7	2X.A-8750.-004	0.5	10	Terminal	0.5	10	Terminal	0.5	10	Terminal
5.5	6SE0140-1.D21-0.A7	2X.A-8750.-005	0.5	10	Terminal	0.5	10	Terminal	0.5	10	Terminal
7.5	6SE0140-1.D21-3.A7	2X.A-8750.-007	0.5	10	Terminal	0.5	10	Terminal	0.5	10	Terminal
11	6SE0140-1.D21-8.A7	2X.A-8750.-011	4	16	Terminal	4	16	Terminal	4	16	Terminal
15	6SE0140-1.D22-5.A7	2X.A-8750.-015	4	16	Terminal	4	16	Terminal	4	16	Terminal
22	6SE0140-1.D23-7.A7	2X.A-8750.-022	0.75	35	Terminal	0.75	35	Terminal	0.75	35	Terminal
30	6SE0140-1.D24-8.A7	2X.A-8750.-030	0.75	35	Terminal	0.75	35	Terminal	0.75	35	Terminal
37	6SE0140-1.D25-8.A7	2X.A-8750.-037	0.75	35	Terminal	0.75	35	Terminal	0.75	35	Terminal
45	6SE0140-1.D27-8.A7	2X.A-8750.-045	2 × 6	2 × 240	1 × M10	2 × 6	2 × 240	1 × M10	2 × 6	2 × 240	1 × M10
55	6SE0140-1.D28-8.A7	2X.A-8750.-055	2 × 6	2 × 240	1 × M10	2 × 6	2 × 240	1 × M10	2 × 6	2 × 240	1 × M10
75	6SE0140-1.D31-1.A7	2X.A-8750.-075	2 × 6	2 × 240	1 × M10	2 × 6	2 × 240	1 × M10	2 × 6	2 × 240	1 × M10
90	6SE0140-1.D31-5.A7	2X.A-8750.-090	2 × 6	2 × 300	1 × M10	2 × 2.5	2 × 150	1 × M6	2 × 6	2 × 300	1 × M10
110	6SE0140-1.D31-8.A7	2X.A-8750.-110	2 × 6	2 × 300	1 × M10	2 × 6	2 × 185	1 × M10	2 × 6	2 × 300	1 × M10
132	6SE0140-1.D32-1.A7	2X.A-8750.-132	2 × 6	2 × 300	1 × M10	2 × 6	2 × 185	1 × M10	2 × 6	2 × 300	1 × M10
160	6SE0140-1.D32-5.A7	2X.A-8750.-160	2 × 6	2 × 300	1 × M10	2 × 6	2 × 185	1 × M10	2 × 6	2 × 300	1 × M10
200	6SE0140-1.D33-0.A7	2X.A-8750.-200	2 × 6	2 × 300	1 × M10	2 × 6	2 × 300	1 × M10	2 × 6	2 × 300	1 × M10
SINAMICS G180 cabinet systems 690 V 6-pulse (230 to 600¹⁾/690 V 3 AC TN/TT or IT system, 50 to 60 Hz)											
7.5	6SE0140-1..21-0.A7	2X.A-8769.-007	4	16	Terminal	4	16	Terminal	4	16	Terminal
11	6SE0140-1..21-3.A7	2X.A-8769.-011	4	16	Terminal	4	16	Terminal	4	16	Terminal
15	6SE0140-1..21-8.A7	2X.A-8769.-015	4	16	Terminal	4	16	Terminal	4	16	Terminal
22	6SE0140-1..22-5.A7	2X.A-8769.-022	4	16	Terminal	4	16	Terminal	4	16	Terminal
30	6SE0140-1..23-4.A7	2X.A-8769.-030	2 × 6	2 × 300	1 × M10	2 × 6	2 × 240	1 × M10	2 × 6	2 × 240	1 × M10
37	6SE0140-1..24-2.A7	2X.A-8769.-037	2 × 6	2 × 300	1 × M10	2 × 6	2 × 240	1 × M10	2 × 6	2 × 240	1 × M10
45	6SE0140-1..25-0.A7	2X.A-8769.-045	2 × 6	2 × 300	1 × M10	2 × 6	2 × 240	1 × M10	2 × 6	2 × 240	1 × M10
55	6SE0140-1..25-8.A7	2X.A-8769.-055	2 × 6	2 × 300	1 × M10	2 × 6	2 × 240	1 × M10	2 × 6	2 × 240	1 × M10
75	6SE0140-1..28-0.A7	2X.A-8769.-075	2 × 6	2 × 300	1 × M10	2 × 6	2 × 240	1 × M10	2 × 6	2 × 240	1 × M10
90	6SE0140-1..31-0.A7	2X.A-8769.-090	2 × 6	2 × 300	1 × M10	2 × 2.5	2 × 150	1 × M6	2 × 6	2 × 300	1 × M10
110	6SE0140-1..31-2.A7	2X.A-8769.-110	2 × 6	2 × 300	1 × M10	2 × 2.5	2 × 150	1 × M6	2 × 6	2 × 300	1 × M10
132	6SE0140-1..31-4.A7	2X.A-8769.-132	2 × 6	2 × 300	1 × M10	2 × 6	2 × 185	1 × M10	2 × 6	2 × 300	1 × M10
160	6SE0140-1..31-7.A7	2X.A-8769.-160	2 × 6	2 × 300	1 × M10	2 × 6	2 × 185	1 × M10	2 × 6	2 × 300	1 × M10
200	6SE0140-1..32-1.A7	2X.A-8769.-200	2 × 6	2 × 300	1 × M10	2 × 6	2 × 185	1 × M10	2 × 6	2 × 300	1 × M10

¹⁾ With an NRTL unit ("U" in 14th position of article number), the voltage range ends at max. 600 V, otherwise at 690 V.

SINAMICS G180

Configuring instructions

Cable cross-sections and connections

Overview (continued)

Type rating	Converter	Converter type	Line connection (standard)			Line connection with main switch or circuit breaker			Motor connection		
			Cable cross-section solid/stranded		Fixing	Cable cross-section solid/stranded		Fixing	Cable cross-section solid/stranded		Fixing
kW	SINAMICS G180		min.	max.		min.	max.		min.	max.	
			IEC	IEC		IEC	IEC		IEC	IEC	
			mm ²	mm ²		mm ²	mm ²		mm ²	mm ²	
SINAMICS G180 cabinet units 400 V 6-pulse, air-cooled and liquid-cooled (230 to 415 V 3 AC TN/TT system, 50 to 60 Hz)											
200	6SE01.0-1BA33-7.A7	2T.A-.7401-200	1 × 10 2 × 150	1 × 300 2 × 300	1 × M12	1 × 2.5 2 × 95	1 × 150 2 × 150	1 × M8	1 × 10 2 × 150	1 × 300 2 × 300	1 × M12
250	6SE01.0-1BA34-6.A7	2T.A-.7401-250	1 × 10 2 × 150	1 × 300 2 × 300	1 × M12	2 × 10	2 × 300	1 × M12	1 × 10 2 × 150	1 × 300 2 × 300	1 × M12
315	6SE01.0-1BA36-3.A7	2T.A-.7401-315	1 × 10 2 × 150	1 × 300 2 × 300	1 × M12	2 × 10	2 × 300	1 × M12	1 × 10 2 × 150	1 × 300 2 × 300	1 × M12
400	6SE01.0-1BA37-3.A7	2T.A-.7401-400	4 × 10	4 × 300	2 × M12	2 × 10 4 × 120	2 × 300 4 × 300	2 × M12	3 × 10 6 × 150	3 × 300 6 × 300	3 × M12
500	6SE01.0-1BA38-8.A7	2T.A-.7401-500	4 × 10	4 × 300	2 × M12	2 × 10 4 × 120	2 × 300 4 × 300	2 × M12	4 × 10 8 × 150	4 × 300 8 × 300	4 × M12
560	6SE01.0-1BA41-0.A7	2T.A-.7401-560	4 × 10	4 × 300	2 × M12	2 × 10 4 × 120	2 × 300 4 × 300	2 × M12	4 × 10 8 × 150	4 × 300 8 × 300	4 × M12
630	6SE01.0-1BA41-1.A7	2T.A-.7401-630	4 × 10	4 × 300	2 × M12	2 × 10 4 × 120	2 × 300 4 × 300	2 × M12	4 × 10 8 × 150	4 × 300 8 × 300	4 × M12
SINAMICS G180 cabinet units 400 V 12-pulse, air-cooled and liquid-cooled (230 to 415 V 3 AC TN/TT system, 50 to 60 Hz)											
200	6SE01.0-2BA33-7.A7	2T.F-.7401-200	1 × 10 2 × 150	1 × 300 2 × 300	1 × M12	1 × 2.5 2 × 95	1 × 150 2 × 150	1 × M8	1 × 10 2 × 150	1 × 300 2 × 300	1 × M12
250	6SE01.0-2BA34-6.A7	2T.F-.7401-250	1 × 10 2 × 150	1 × 300 2 × 300	1 × M12	2 × 10	2 × 300	1 × M12	1 × 10 2 × 150	1 × 300 2 × 300	1 × M12
315	6SE01.0-2BA36-3.A7	2T.F-.7401-315	1 × 10 2 × 150	1 × 300 2 × 300	1 × M12	2 × 10	2 × 300	1 × M12	1 × 10 2 × 150	1 × 300 2 × 300	1 × M12
400	6SE01.0-2BA37-3.A7	2T.F-.7401-400	4 × 10	4 × 300	2 × M12	2 × 10 4 × 120	2 × 300 4 × 300	2 × M12	3 × 10 6 × 150	3 × 300 6 × 300	3 × M12
500	6SE01.0-2BA38-8.A7	2T.F-.7401-500	4 × 10	4 × 300	2 × M12	2 × 10 4 × 120	2 × 300 4 × 300	2 × M12	4 × 10 8 × 150	4 × 300 8 × 300	4 × M12
560	6SE01.0-2BA41-0.A7	2T.F-.7401-560	4 × 10	4 × 300	2 × M12	2 × 10 4 × 120	2 × 300 4 × 300	2 × M12	4 × 10 8 × 150	4 × 300 8 × 300	4 × M12
630	6SE01.0-2BA41-1.A7	2T.F-.7401-630	4 × 10	4 × 300	2 × M12	2 × 10 4 × 120	2 × 300 4 × 300	2 × M12	4 × 10 8 × 150	4 × 300 8 × 300	4 × M12
SINAMICS G180 cabinet units 500 V 6-pulse, air-cooled and liquid-cooled (230 to 500 V 3 AC IT system, 50 to 60 Hz)											
250	6SE01.0-1BD33-7.A7	2T.A-.7501-250	1 × 10 2 × 150	1 × 300 2 × 300	1 × M12	1 × 2.5 2 × 95	1 × 150 2 × 150	1 × M8	1 × 10 2 × 150	1 × 300 2 × 300	1 × M12
315	6SE01.0-1BD34-6.A7	2T.A-.7501-315	1 × 10 2 × 150	1 × 300 2 × 300	1 × M12	2 × 10	2 × 300	1 × M12	1 × 10 2 × 150	1 × 300 2 × 300	1 × M12
400	6SE01.0-1BD36-3.A7	2T.A-.7501-400	1 × 10 2 × 150	1 × 300 2 × 300	1 × M12	2 × 10	2 × 300	1 × M12	1 × 10 2 × 150	1 × 300 2 × 300	1 × M12
500	6SE01.0-1BD37-3.A7	2T.A-.7501-500	4 × 10	4 × 300	2 × M12	2 × 10 4 × 120	2 × 300 4 × 300	2 × M12	3 × 10 6 × 150	3 × 300 6 × 300	3 × M12
560	6SE01.0-1BD38-2.A7	2T.A-.7501-560	4 × 10	4 × 300	2 × M12	2 × 10 4 × 120	2 × 300 4 × 300	2 × M12	4 × 10 8 × 150	4 × 300 8 × 300	4 × M12
630	6SE01.0-1BD38-8.A7	2T.A-.7501-630	4 × 10	4 × 300	2 × M12	2 × 10 4 × 120	2 × 300 4 × 300	2 × M12	4 × 10 8 × 150	4 × 300 8 × 300	4 × M12
710	6SE01.0-1BD41-0.A7	2T.A-.7501-710	4 × 10	4 × 300	2 × M12	2 × 10 4 × 120	2 × 300 4 × 300	2 × M12	4 × 10 8 × 150	4 × 300 8 × 300	4 × M12
800	6SE01.0-1BD41-1.A7	2T.A-.7501-800	4 × 10	4 × 300	2 × M12	2 × 10 4 × 120	2 × 300 4 × 300	2 × M12	4 × 10 8 × 150	4 × 300 8 × 300	4 × M12

Overview (continued)

Type rating	Converter	Converter type	Line connection (standard)		Line connection with main switch or circuit breaker			Motor connection			
			Cable cross-section solid/stranded	Fixing	Cable cross-section solid/stranded	Fixing	Cable cross-section solid/stranded	Fixing			
kW	SINAMICS G180		min. IEC mm ²	max. IEC mm ²	min. IEC mm ²	max. IEC mm ²	min. IEC mm ²	max. IEC mm ²	min. IEC mm ²	max. IEC mm ²	
SINAMICS G180 cabinet units 500 V 12-pulse, air-cooled and liquid-cooled (2 × 230 to 500 V 3 AC IT system, 50 to 60 Hz)											
250	6SE01.0-2BD33-7.A7	2T.F. 7501-250			2 × 6	2 × 185	1 × M10	1 × 10 2 × 150	1 × 300 2 × 300	1 × M12	
315	6SE01.0-2BD34-6.A7	2T.F. 7501-315			2 × 6	2 × 185	1 × M10	1 × 10 2 × 150	1 × 300 2 × 300	1 × M12	
400	6SE01.0-2BD36-3.A7	2T.F. 7501-400			2 × 6	2 × 300	1 × M10	1 × 10 2 × 150	1 × 300 2 × 300	1 × M12	
500	6SE01.0-2BD37-3.A7	2T.F. 7501-500			2 × 6	2 × 300	1 × M10	3 × 10 6 × 150	3 × 300 6 × 300	3 × M12	
560	6SE01.0-2BD38-2.A7	2T.F. 7501-560			2 × 6	2 × 300	1 × M10	4 × 10 8 × 150	4 × 300 8 × 300	4 × M12	
630	6SE01.0-2BD38-8.A7	2T.F. 7501-630			2 × 6	2 × 300	1 × M10	4 × 10 8 × 150	4 × 300 8 × 300	4 × M12	
710	6SE01.0-2BD41-0.A7	2T.F. 7501-710			2 × 6	2 × 300	1 × M10	4 × 10 8 × 150	4 × 300 8 × 300	4 × M12	
800	6SE01.0-2BD41-1.A7	2T.F. 7501-800			2 × 6	2 × 300	1 × M10	4 × 10 8 × 150	4 × 300 8 × 300	4 × M12	
SINAMICS G180 cabinet units 690 V 6-pulse, air-cooled and liquid-cooled (230 to 600¹⁾/690 V 3 AC TN/TT or IT system, 50 to 60 Hz)											
250	6SE01.0-1B.33-2.A7	2T.A. 7601-250	2 × 10	2 × 300	1 × M12	1 × 2.5 2 × 95	1 × 150 2 × 150	1 × M8	1 × 10 2 × 150	1 × 300 2 × 300	1 × M12
315	6SE01.0-1B.33-6.A7	2T.A. 7601-315	2 × 10	2 × 300	1 × M12	1 × 2.5 2 × 95	1 × 150 2 × 150	1 × M8	1 × 10 2 × 150	1 × 300 2 × 300	1 × M12
400	6SE01.0-1B.34-2.A7	2T.A. 7601-400	2 × 10	2 × 300	1 × M12	2 × 10	2 × 300	1 × M12	1 × 10 2 × 150	1 × 300 2 × 300	1 × M12
500	6SE01.0-1B.35-2.A7	2T.A. 7601-500	2 × 10	2 × 300	1 × M12	2 × 6	2 × 300	1 × M10	3 × 10 6 × 150	3 × 300 6 × 300	3 × M12
560	6SE01.0-1B.35-7.A7	2T.A. 7601-560	4 × 10	4 × 300	2 × M12	2 × 10 4 × 120	2 × 300 4 × 300	2 × M12	4 × 10 8 × 150	4 × 300 8 × 300	4 × M12
630	6SE01.0-1B.36-4.A7	2T.A. 7601-630	4 × 10	4 × 300	2 × M12	2 × 10 4 × 120	2 × 300 4 × 300	2 × M12	4 × 10 8 × 150	4 × 300 8 × 300	4 × M12
710	6SE01.0-1B.37-1.A7	2T.A. 7601-710	4 × 10	4 × 300	2 × M12	2 × 10 4 × 120	2 × 300 4 × 300	2 × M12	4 × 10 8 × 150	4 × 300 8 × 300	4 × M12
800	6SE01.0-1B.37-7.A7	2T.A. 7601-800	4 × 10	4 × 300	2 × M12	2 × 10 4 × 120	2 × 300 4 × 300	2 × M12	4 × 10 8 × 150	4 × 300 8 × 300	4 × M12
900	6SE01.0-1B.41-0.A7	2T.A. 7601-909	4 × 10	4 × 300	2 × M12	2 × 10 4 × 120	2 × 300 4 × 300	2 × M12	4 × 10 8 × 150	4 × 300 8 × 300	4 × M12
1000	6SE01.0-1B.41-1.A7	2T.A. 7601-910	4 × 10	4 × 300	2 × M12	2 × 10 4 × 120	2 × 300 4 × 300	2 × M12	4 × 10 8 × 150	4 × 300 8 × 300	4 × M12
1200	6SE01.0-1C.41-2.A7	2T.A. 7602-912	8 × 10	8 × 300	2 × 2 × M12	2 × 10 4 × 120	2 × 300 4 × 300	2 × M12	8 × 10 16 × 150	8 × 300 16 × 300	2 × 4 × M12
1300	6SE01.0-1C.41-3.A7	2T.A. 7602-913	8 × 10	8 × 300	2 × 2 × M12	2 × 10 4 × 120	2 × 300 4 × 300	2 × M12	8 × 10 16 × 150	8 × 300 16 × 300	2 × 4 × M12
1500	6SE01.0-1C.41-5.A7	2T.A. 7602-915	8 × 10	8 × 300	2 × 2 × M12	2 × 10 4 × 120	2 × 300 4 × 300	2 × M12	8 × 10 16 × 150	8 × 300 16 × 300	2 × 4 × M12
1100	6SE01.0-1C.41-7.A7	2T.A. 7602-917	8 × 10	8 × 300	2 × 2 × M12	²⁾	²⁾	²⁾	8 × 10 16 × 150	8 × 300 16 × 300	2 × 4 × M12
1900	6SE01.0-1C.42-0.A7	2T.A. 7602-919	8 × 10	8 × 300	2 × 2 × M12	²⁾	²⁾	²⁾	8 × 10 16 × 150	8 × 300 16 × 300	2 × 4 × M12

¹⁾ With an NRTL unit ("U" in 14th position of article number), the voltage range ends at max. 600 V, otherwise at 690 V. ²⁾ On request.

SINAMICS G180

Configuring instructions

Cable cross-sections and connections

Overview (continued)

Type rating	Converter	Converter type	Line connection (standard)			Line connection with main switch or circuit breaker (Options: S01, S02, S03, S04, S06, S08, S09, S11, S12, S21, S22, S23, S24, S41)			Motor connection		
			Cable cross-section solid/stranded		Fixing	Cable cross-section solid/stranded		Fixing	Cable cross-section solid/stranded		Fixing
kW			min. IEC mm ²	max. IEC mm ²		min. IEC mm ²	max. IEC mm ²		min. IEC mm ²	max. IEC mm ²	
SINAMICS G180 cabinet units 690 V 12-pulse, air-cooled and liquid-cooled (2 × 400 to 600¹⁾/690 V 3 AC IT system, 50 to 60 Hz)											
250	6SE01.0-2BH33-2.A7	2T.F. 7601-250				2 × 2.5	2 × 150	1 × M6	1 × 10 2 × 150	1 × 300 2 × 300	1 × M12
315	6SE01.0-2BH33-6.A7	2T.F. 7601-315				2 × 6	2 × 185	1 × M10	1 × 10 2 × 150	1 × 300 2 × 300	1 × M12
400	6SE01.0-2BH34-2.A7	2T.F. 7601-400				2 × 6	2 × 185	1 × M10	1 × 10 2 × 150	1 × 300 2 × 300	1 × M12
500	6SE01.0-2BH35-2.A7	2T.F. 7601-500				2 × 6	2 × 300	1 × M10	3 × 10 6 × 150	3 × 300 6 × 300	3 × M12
560	6SE01.0-2BH35-7.A7	2T.F. 7601-560				2 × 6	2 × 300	1 × M10	4 × 10 8 × 150	4 × 300 8 × 300	4 × M12
630	6SE01.0-2BH36-4.A7	2T.F. 7601-630				2 × 6	2 × 300	1 × M10	4 × 10 8 × 150	4 × 300 8 × 300	4 × M12
710	6SE01.0-2BH37-1.A7	2T.F. 7601-710				2 × 6	2 × 300	1 × M10	4 × 10 8 × 150	4 × 300 8 × 300	4 × M12
800	6SE01.0-2BH37-7.A7	2T.F. 7601-800				2 × 6	2 × 300	1 × M10	4 × 10 8 × 150	4 × 300 8 × 300	4 × M12
900	6SE01.0-2BH41-0.A7	2T.F. 7601-909				2 × 6	2 × 300	1 × M10	4 × 10 8 × 150	4 × 300 8 × 300	4 × M12
1000	6SE01.0-2BH41-1.A7	2T.F. 7601-910				2 × 6	2 × 300	1 × M10	4 × 10 8 × 150	4 × 300 8 × 300	4 × M12
1200	6SE01.0-2CH41-2.A7	2T.F. 7602-912				2 × 10 4 × 120	2 × 300 4 × 300	2 × M12	8 × 10 16 × 150	8 × 300 16 × 300	2 × 4 × M12
1300	6SE01.0-2CH41-3.A7	2T.F. 7602-913				2 × 10 4 × 120	2 × 300 4 × 300	2 × M12	8 × 10 16 × 150	8 × 300 16 × 300	2 × 4 × M12
1500	6SE01.0-2CH41-5.A7	2T.F. 7602-915				2 × 10 4 × 120	2 × 300 4 × 300	2 × M12	8 × 10 16 × 150	8 × 300 16 × 300	2 × 4 × M12
1100	6SE01.0-2CH41-7.A7	2T.F. 7602-917				2 × 10 4 × 120	2 × 300 4 × 300	2 × M12	8 × 10 16 × 150	8 × 300 16 × 300	2 × 4 × M12
1900	6SE01.0-2CH42-0.A7	2T.F. 7602-919				2 × 10 4 × 120	2 × 300 4 × 300	2 × M12	8 × 10 16 × 150	8 × 300 16 × 300	2 × 4 × M12
2000	6SE01.0-2DH42-2.A7	2T.F. 7603-920				2 × 10 4 × 120	2 × 300 4 × 300	2 × M12	12 × 10 24 × 150	12 × 120 24 × 300	3 × 4 × M12
2300	6SE01.0-2DH42-4.A7	2T.F. 7603-923				2 × 10 4 × 120	2 × 300 4 × 300	2 × M12	12 × 10 24 × 150	12 × 120 24 × 300	3 × 4 × M12
2600	6SE01.0-2DH42-7.A7	2T.F. 7603-926				2 × 10 4 × 120	2 × 300 4 × 300	2 × M12	12 × 10 24 × 150	12 × 120 24 × 300	3 × 4 × M12
2900	6SE01.0-2DH43-0.A7	2T.F. 7603-929				2 × 10 4 × 120	2 × 300 4 × 300	2 × M12	12 × 10 24 × 150	12 × 120 24 × 300	3 × 4 × M12
3100	6SE01.0-2EH43-2.A7	2T.F. 7604-931				2) ²⁾	2) ²⁾	2) ²⁾	16 × 10 32 × 150	16 × 120 32 × 300	4 × 4 × M12
3500	6SE01.0-2EH43-6.A7	2T.F. 7604-935				2) ²⁾	2) ²⁾	2) ²⁾	16 × 10 32 × 150	16 × 120 32 × 300	4 × 4 × M12
3900	6SE01.0-2EH44-0.A7	2T.F. 7604-939				2) ²⁾	2) ²⁾	2) ²⁾	16 × 10 32 × 150	16 × 120 32 × 300	4 × 4 × M12

¹⁾ With an NRTL unit ("U" in 14th position of article number), the voltage range ends at max. 600 V, otherwise at 690 V.

²⁾ On request.

Overview (continued)

Type rating	Converter	Converter type	Line connection (standard)		Line connection with main switch or circuit breaker (Options: S01, S02, S03, S04, S06, S08, S09, S11, S12, S21, S22, S23, S24, S41)			Motor connection		
			Cable cross-section solid/stranded	Fixing	Cable cross-section solid/stranded	Fixing	Cable cross-section solid/stranded	Fixing		
kW			min. IEC mm ²	max. IEC mm ²	min. IEC mm ²	max. IEC mm ²	min. IEC mm ²	max. IEC mm ²		
SINAMICS G180 cabinet units 690 V 18-pulse, air-cooled and liquid-cooled (3 × 400 to 600¹)/690 V 3 AC IT system, 50 to 60 Hz										
2000	6SE01.0-3DH42-2.A7	2T.K-.7603-920			2 × 10 4 × 120	2 × 300 4 × 300	2 × M12	12 × 10 24 × 150	12 × 120 24 × 300	3 × 4 × M12
2300	6SE01.0-3DH42-4.A7	2T.K-.7603-923			2 × 10 4 × 120	2 × 300 4 × 300	2 × M12	12 × 10 24 × 150	12 × 120 24 × 300	3 × 4 × M12
2600	6SE01.0-3DH42-7.A7	2T.K-.7603-926			2 × 10 4 × 120	2 × 300 4 × 300	2 × M12	12 × 10 24 × 150	12 × 120 24 × 300	3 × 4 × M12
2900	6SE01.0-3DH43-0.A7	2T.K-.7603-929			2 × 10 4 × 120	2 × 300 4 × 300	2 × M12	12 × 10 24 × 150	12 × 120 24 × 300	3 × 4 × M12
4100	6SE01.0-3HH44-3.A7	2T.K-.7606-941			2 × 10 4 × 120	2 × 300 4 × 300	2 × M12	24 × 10 48 × 150	24 × 300 48 × 300	6 × 4 × M12
4100	6SE01.0-3HH44-8.A7	2T.K-.7606-947			2) ²⁾	2) ²⁾	2) ²⁾	24 × 10 48 × 150	24 × 300 48 × 300	6 × 4 × M12
5300	6SE01.0-3HH45-4.A7	2T.K-.7606-953			2) ²⁾	2) ²⁾	2) ²⁾	24 × 10 48 × 150	24 × 300 48 × 300	6 × 4 × M12
5800	6SE01.0-3HH46-0.A7	2T.K-.7606-958			2) ²⁾	2) ²⁾	2) ²⁾	24 × 10 48 × 150	24 × 300 48 × 300	6 × 4 × M12
SINAMICS G180 cabinet units 690 V 24-pulse, air-cooled and liquid-cooled (4 × 400 to 600¹)/690 V 3 AC IT system, 50 to 60 Hz										
1200	6SE01.0-4CH41-2.A7	2T.L-.7602-912			2 × 6	2 × 300	1 × M10	8 × 10 16 × 150	8 × 300 16 × 300	2 × 4 × M12
1300	6SE01.0-4CH41-3.A7	2T.L-.7602-913			2 × 6	2 × 300	1 × M10	8 × 10 16 × 150	8 × 300 16 × 300	2 × 4 × M12
1500	6SE01.0-4CH41-5.A7	2T.L-.7602-915			2 × 6	2 × 300	1 × M10	8 × 10 16 × 150	8 × 300 16 × 300	2 × 4 × M12
1100	6SE01.0-4CH41-7.A7	2T.L-.7602-917			2 × 6	2 × 300	1 × M10	8 × 10 16 × 150	8 × 300 16 × 300	2 × 4 × M12
1900	6SE01.0-4CH42-0.A7	2T.L-.7602-919			2 × 6	2 × 300	1 × M10	8 × 10 16 × 150	8 × 300 16 × 300	2 × 4 × M12
3100	6SE01.0-4EH43-2.A7	2T.L-87604-931			2 × 10 4 × 120	2 × 300 4 × 300	2 × M12	16 × 10 32 × 150	16 × 120 32 × 300	4 × 4 × M12
3500	6SE01.0-4EH43-6.A7	2T.L-87604-935			2 × 10 4 × 120	2 × 300 4 × 300	2 × M12	16 × 10 32 × 150	16 × 120 32 × 300	4 × 4 × M12
3900	6SE01.0-4EH44-0.A7	2T.L-87604-939			2 × 10 4 × 120	2 × 300 4 × 300	2 × M12	16 × 10 32 × 150	16 × 120 32 × 300	4 × 4 × M12
4100	6SE01.0-4HH44-3.A7	2T.L-87606-941			2 × 10 4 × 120	2 × 300 4 × 300	2 × M12	24 × 10 48 × 150	24 × 300 48 × 300	6 × 4 × M12
4100	6SE01.0-4HH44-8.A7	2T.L-87606-947			2 × 10 4 × 120	2 × 300 4 × 300	2 × M12	24 × 10 48 × 150	24 × 300 48 × 300	6 × 4 × M12
5300	6SE01.0-4HH45-4.A7	2T.L-87606-953			2 × 10 4 × 120	2 × 300 4 × 300	2 × M12	24 × 10 48 × 150	24 × 300 48 × 300	6 × 4 × M12
5800	6SE01.0-4HH46-0.A7	2T.L-87606-958			2 × 10 4 × 120	2 × 300 4 × 300	2 × M12	24 × 10 48 × 150	24 × 300 48 × 300	6 × 4 × M12

Note:

Device cable lugs must be used to connect cables to the main switch or circuit breaker. These cable lugs are narrower, for example, than DIN cable lugs. The lugs are not normally supplied with the converter since they are generally provided by the cable installer.

It is generally possible to request a customized line connection or motor connection, see "Engineer To Order – ETO" under "Option descriptions" on Page 4/34. Please ask your Siemens contact person for further details.

¹⁾ With an NRTL unit ("U" in 14th position of article number), the voltage range ends at max. 600 V, otherwise at 690 V.

²⁾ On request.

SINAMICS G180

Configuring instructions

Cable cross-sections and connections

Overview (continued)

Converter connection for different pulse numbers

Pulse number	Line connection on converter
6	Three phases
12	Two transformer secondary systems, each with three phases, i.e. six phases in total. Both systems must be phase offset by 30° in each case, e.g. using the transformer vector group Dy5d6. Important: Does not apply to 400 V units owing to the shift transformer solution – the line connection for these units is made with three phases.
18	Three transformer secondary systems, each with three phases, i.e. nine phases in total. The three systems must be phase offset by 20° in each case, e.g. using the transformer vector group Dy0y+20y-20.
24	Four transformer secondary systems, each with three phases, i.e. twelve phases in total. The four systems must be phase offset by 15° in each case, e.g. by two transformers with vector groups Dy5.25d6.25 and Dy4.75d5.75.

Required cable cross-sections for line and motor connections

In order to ensure compliance with the EMC Directive, it is generally recommended that shielded cables or cables with a concentric PE conductor of type NYCWY are used to make the cable connections from the mains supply to the converter and from the converter to the motor.

Where possible, symmetrical 3-wire three-phase power cables should be installed between the converter and the motor on drives in the higher power range. It may be necessary to connect several of these cables in parallel. There are basically two reasons for this recommendation:

- This is the only way in which the high IP55 degree of protection can be achieved for the motor terminal box without problems, because the cables enter the terminal box via glands and the number of possible glands is limited by the geometry of the terminal box. Therefore single cables are less suitable.
- With symmetrical 3-wire three-phase cables, the summed ampere-turns over the cable outer diameter are equal to zero. They can be routed in conductive, metal cable ducts or racks without any significant currents (ground currents or leakage currents) being induced in these conductive metal connections. The danger of induced leakage currents and thus of increased cable sheath losses is significantly higher with single-wire cables.

Dimensioning of connecting cable between mains supply and converter:

- The voltage load on the cable should equal at least $V_0/V = 0.6/1$ kV.
- Current load:
 - The cable cross-section must be dimensioned in accordance with the valid standards, e.g. IEC 60364-5-52.
 - The mains cable is dimensioned according to the converter input current (specified on the type plate).
- Precaution against injury due to indirect contact:
 - An overcurrent protective device with additional equipotential bonding at the motor protects against injury caused by indirect contact.
- A neutral conductor is not required.

Dimensioning of connecting cable between converter and motor:

- The voltage load on the cable should equal at least $V_0/V = 0.6/1$ kV.
- Current load:
 - The cable cross-section must be dimensioned in accordance with the valid standards, e.g. IEC 60364-5-52.
 - The motor cable is dimensioned according to the converter output current (specified on the type plate).

The required cable cross-section depends on the amperage which flows through the cable. The permissible current loading of cables is defined, for example, in IEC 60364-5-52. It depends on ambient conditions, such as temperature, but also on the routing method. An important factor to consider is whether cables are routed singly and are therefore relatively well ventilated, or whether groups of cables are routed together. In the latter instance, the cables are not ventilated so well and might therefore heat one another to a greater degree. For the relevant correction factors applicable to these boundary conditions, please refer to IEC 60364-5-52. The table below provides a guide to the recommended cross-sections (based on IEC 60364-5-52) for PVC-insulated, 3-wire copper and aluminum cables, a permissible conductor temperature of 70 °C (e.g. Protodur NYY or NYCWY) and an ambient temperature of 40 °C.

Overview (continued)

Current-carrying capacity according to IEC 60364-5-52 at 40 °C

Cross-section 3-wire cable mm ²	3-wire copper cable		3-wire aluminum cable	
	Single routing	Groups of cables routed in parallel ¹⁾	Single routing	Groups of cables routed in parallel ¹⁾
3 × 2.5	22	17	17	13
3 × 4.0	30	23	23	18
3 × 6.0	37	29	29	22
3 × 10	52	41	40	31
3 × 16	70	54	53	41
3 × 25	88	69	68	53
3 × 35	110	86	84	65
3 × 50	133	104	102	79
3 × 70	171	133	131	102
3 × 95	207	162	159	124
3 × 120	240	187	184	144
3 × 150	278	216	213	166
3 × 185	317	247	244	190
3 × 240	374	292	287	224
3 × 300	432	337	331	259

With higher amperages, cables must be connected in parallel.

Note:

The recommendations for the North American market in AWG or MCM must be taken from the appropriate NEC (National Electrical Code) and/or CEC (Canadian Electrical Code) standards.

Grounding and PE conductor cross-section

The PE conductor must be dimensioned to meet the following requirements:

- In the case of a ground fault, no impermissibly high contact voltages resulting from voltage drops on the PE conductor caused by the ground fault current may occur (< 50 V AC or < 120 V DC, IEC 61800-5-1, IEC 60364, IEC 60543).
- The PE conductor should not be excessively loaded by any ground fault current it carries.
- If it is possible for continuous currents to flow through the PE conductor when a fault occurs, the PE conductor cross-section must be dimensioned for this continuous current.
- The PE conductor cross-section should be selected according to IEC 60204-1, IEC 60439-1, IEC 60364.

Cross-section of the phase conductor mm ²	Minimum cross-section of external PE conductor mm ²
≤ 16	Minimum phase conductor cross-section
16 ... 35	16
≥ 35	Minimum half the phase conductor cross-section

Note:

The recommendations for the North American market in AWG or MCM must be taken from the appropriate NEC (National Electrical Code) and/or CEC (Canadian Electrical Code) standards.

- Switchgear and motors are usually grounded separately via separate local ground connections. When this grounding arrangement is used, the current caused by a ground fault flows through the parallel ground connections and is divided. Despite the use of the relatively small PE conductor cross-sections specified in the table above, no impermissible contact voltages can develop with this grounding system. Based on experience with different grounding configurations, however, we recommend that the ground wire from the motor should be routed directly back to the converter. For EMC reasons and to prevent bearing currents, symmetrical 3-wire, three-phase cables should be used where possible instead of 4-wire cables, especially on drives in the higher power range. The protective or PE conductor must be routed separately when 3-wire cables are used or must be arranged symmetrically in the motor cable. The symmetry of the PE conductor is achieved using a conductor surrounding all phase conductors or using a cable with a symmetrical arrangement of the three phase conductors and three ground conductors.
- Through their high-speed controllers, the converters limit the load current (motor and ground fault currents) to an rms value corresponding to the rated current. We therefore recommend the use of a PE conductor cross-section analogous to the phase conductor cross-section for grounding the control cabinet.

¹⁾ Maximum 9 cables may be routed horizontally in direct contact with one another on a cable rack (reduction factor 0.68).

SINAMICS G180

Configuring instructions

Standard interface

Overview

5

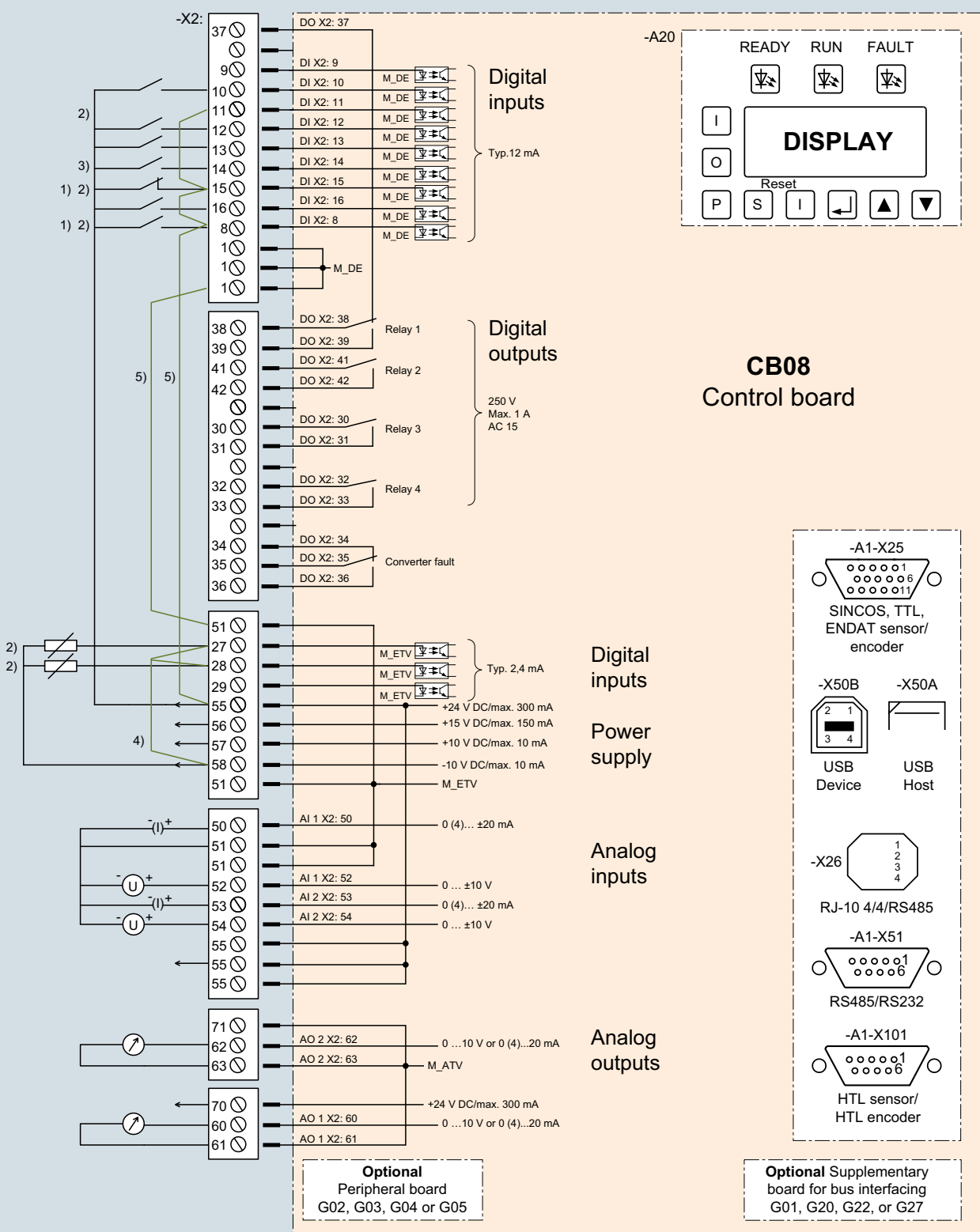

1) Global = functional for "Local" and "Remote"
 2) Remove the jumper if used.
 3) As long as "P-INTERFACES: Reset source" is set to "Global", all reset sources are always effective.

4) Max. current load of the control voltages: +24 V DC, potential 2: 300 mA
 +15 V DC, potential 2: 150 mA
 +10 V DC, potential 2: 10 mA
 -10 V DC, potential 2: 10 mA
 5) Remove both of these jumpers for peripheral board 3 / 4. Power is supplied through -X2:1/3.

G_ D024_EN_00010

Overview (continued)

Standard assignment of inputs/outputs

The following table shows the default assignments of the interface for a "standard" application.

Signal designation	Function
Digital input signals of module "CB08"	
Internal digital input 8	Controller enable global 1
Internal digital input 9	Freely parameterizable
Internal digital input 10	Speed ON remote
Internal digital input 11	Freely parameterizable
Internal digital input 12	Local/remote, remote=1
Internal digital input 13	External fault
Internal digital input 14	Remote reset
Internal digital input 15	Rapid stop global 1
Internal digital input 16	Reverse remote
Internal digital input 27	PTC thermistor trip (not for explosion-proof motors)
Internal digital input 28	PTC thermistor prewarning (not for explosion-proof motors)
Internal digital input 29	External warning
Digital output signals of module "CB08"	
Internal digital output 37, 38, 39	Relay 1: "Ready"
Internal digital output 41, 42	Relay 2: "Operation"
Internal digital output 30, 31	Relay 3: "Alarm"
Internal digital output 32, 33	Relay 4: Not assigned
Internal digital output 34, 35, 36	"Converter fault"
Analog input signals of module "CB08"	
Internal analog input 50, 51, 52	Speed setpoint
Internal analog input 53, 54	User-assignable connection
Analog output signals of module "CB08"	
Internal analog output 60, 61	Motor speed
Internal analog output 62, 63	Motor current

NAMUR-compliant assignment of inputs/outputs

The following table shows the default assignments of the interface for a "NAMUR" application.

Signal designation	Function
Digital input signals of module "CB08"	
Internal digital input 8	Main contactor checkback
Internal digital input 9	Test/Normal switch on converter
Internal digital input 10	ON/OFF static; ON dynamic (controller enable ON)
Internal digital input 11	OFF dynamic (controller enable OFF)
Internal digital input 12	Fast (motorized potentiometer UP)
Internal digital input 13	Slow (motorized potentiometer DOWN)
Internal digital input 14	Reset normal
Internal digital input 15	Interlock (controller disable)
Internal digital input 16	Reverse normal
Internal digital input 27	Freely parameterizable
Internal digital input 28	Freely parameterizable
Internal digital input 29	Freely parameterizable
Digital output signals of module "CB08"	
Internal digital output 37, 38, 39	Relay 1: "Group prewarning"
Internal digital output 41, 42	Relay 2: "Main(line)contactor closed"
Internal digital output 30, 31	Relay 3: "Ready"
Internal digital output 32, 33	Relay 4: "Motor turning"
Internal digital output 34, 35, 36	"Converter fault"
Analog input signals of module "CB08"	
Internal analog input 50, 51, 52	Speed setpoint (terminal 50/51 or 52/51)
Internal analog input 53, 54	Actual process value/user-assignable input (terminal 53/51 or 54/51)
Analog output signals of module "CB08"	
Internal analog output 60, 61	Motor speed
Internal analog output 62, 63	Motor current

SINAMICS G180

Configuring instructions

Communication possibilities

Overview

Operating principle

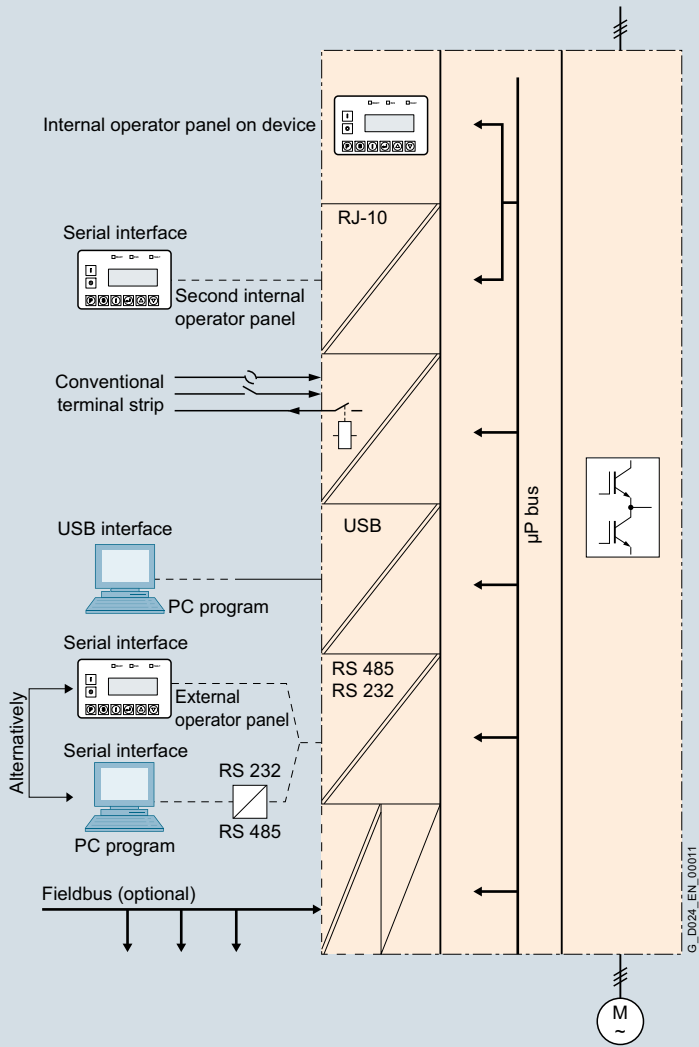

5

Overview

SIEMENS	
SINAMICS G180	
FREQUENZUMRICHTER / AC DRIVE	
(1P)	6SE0180-1BA35-8AA7-Z +C55+E46+G01+G05+L00+L10+M06+M39+S01
(S)	LDX/7505033
TYPE:	2T3A-87401-3150AVEP4
MAT-NO:	L4-10000005
INPUT:	3 AC 400 V 582 A 403 kVA 50/60 Hz
OUTPUT:	3 AC 0...400 V 630 A 436 kVA 0...250 Hz
SHORT CIRCUIT CURRENT:	
DUTY CLASS:	50 kA
COOLING METHOD:	I
WEIGHT:	AF
TEMPERATURE RANGE:	530 kg
DEGREE OF PROTECTION:	0...40°C
YEAR OF MANUFACTURE:	IP21
	2012
CE	
Siemens AG, Hans-Loher-Str. 32, DE-94099 Ruhstorf a. d. Rott	
Made in Germany	
86	

G_D024_EN_00038

91

Line	Example of type plate	Description
SINAMICS G180		Product name
(1P)	6SE0180-1BA35-8AA7-Z +C55+E46+G01+G05+L00+L10+M06+M39+S01	Article number of the converter Converter options
(S)	LDX/ 7505033	LDX/ → Ruhstorf manufacturing location 7505033 → serial number of the converter
TYPE	2T3A-87401-3150AVEP4	Type code of the converter
MAT-NO	L4-10000005	Material number of the converter
INPUT	3 AC 400 V 582 A 403 kVA 50/60 Hz	Line-end electrical data
OUTPUT	3 AC 0 ... 400 V 630 A 436 kVA 0 ... 250 Hz	Motor-end electrical data
SHORT CIRCUIT CURRENT	50 kA	Rated short-circuit current
DUTY CLASS	I	Converter duty class
COOLING METHOD	AF	Method of converter cooling AF = Air Forced WF = Water Forced AN = Air Natural (convection)
WEIGHT	530 kg	Converter weight
TEMPERATURE RANGE	0 ... 40 °C	Ambient temperature
DEGREE OF PROTECTION	IP21	Protection class
YEAR OF MANUFACTURE	2012	Year of manufacture
	Siemens AG Hans-Loher-Str.32 DE-94099 Ruhstorf a. d. Rott	Manufacturer's address
	Made in Germany	Country of origin

SINAMICS G180

Configuring instructions

ZLU - Supplementary Supply Agreements for Converter Drives in Power Plants

Overview

The VDEW publication ZLU (Zusätzliche Liefervereinbarungen für Umrichterantriebe in Kraftwerken (Supplementary Supply Agreements for Converter Drives in Power Plants), 1st Edition 1997) describes the design of frequency converters for power plant applications. It is noted in the preface of this document that the ZLU does not constitute a standard in the sense of a VDE regulation, but describes requirements and/or technical data and equipment details which apply additionally to converter drives used for power plant applications.

Several chapters are dedicated to describing the extensive range of equipment documentation. The KKS (Kraftwerkskennzeichnungssystem), a standardized identification system for power plants, must generally be applied throughout the documentation. As a minimum requirement, the correct KKS No. for the drive must always be stated in the documentation. The documentation must describe the converter interfaces in such a way that the destination and the type and number of used cables are clear even if these are not included in the scope of supply of the converter.

Furthermore, supplementary rules regarding documentation apply in every power plant and these must also be taken into account. These rules must generally be stated as special requirements, e.g. under "Engineer To Order – ETO" (X80), see Option descriptions on Page 4/34.

Noise emission values which might require a special design are specified in Section 1.10. Where applicable, these must be stated or selected as special requirements in options.

The ZLU also describes the converter transformer and the motor. This information must be taken into account in the design of these components.

The electrical design specifications (Chapter 4) state that the operating device must also include a key-operated switch for local control of the converter. It is further stated that the incoming supply must be connected via a fuse switch disconnecter and main contactor or via a circuit breaker. Generally speaking, requirements often deviate from this specification. The key-operated switch and the line-side power switchgear must be selected in a further option. Unless the order contains any additional information, option **S12** must be selected. This includes the local key-operated switch and the circuit breaker. Option **S02** is often selected as well.

Chapter 1.5 "Rated output" states that the drive may continuously output at least 105 %, but maximum 120 %, of the shaft power required in maximum-load operation of the driven machine. This means that the converters must always be designed with a 5 % power reserve. This must be taken into account in the drive design. Option X51 "Extended overvoltage range" does not include any power reserves, see "Engineer To Order – ETO" under Option descriptions on Page 4/34.

The device testing procedures are described in Chapter 6 "Quality assurance, Testing, Acceptance". It includes a description of routine and type tests and prescribes type tests as mandatory for first deliveries. It is not acceptable to test a selected component from a series. The operator or the ordering party or his/her representative must be given the opportunity to carry out test inspections during the manufacturing process.

Furthermore, the total efficiency (transformer, converter, motor) must be verified by computation or in a test bay or at the site of installation.

Many tests are also specified as optional subject to agreement. These must be selected in the form of additional options. The test requirements specified in the ZLU are fulfilled with one of the options **F82, F83, F84, F85** (warm-up with original motor).

Chapter 1.9 "Operational requirements" specifies special power system data in the event of load shedding of the turbine generator and offloading to auxiliary supply. The converters must remain in operation in the event of a brief frequency increase to $1.1 f_r$ for 5 s with simultaneous voltage increase to $1.25 \times V_r$ for 2 s. Depending on operational requirements, it might be necessary to agree voltage values of up to $1.4 \times V_r$. It is not possible to implement this brief overvoltage load capacity on every converter (see option description X51 Extended voltage range).

SIZER for Siemens Drives engineering tool

Overview

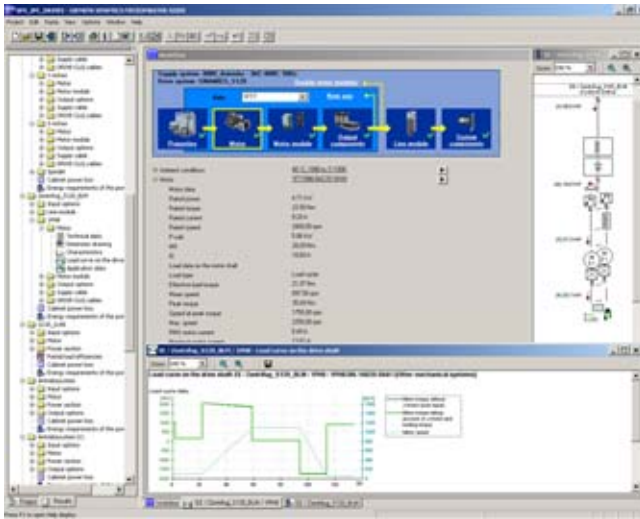

The following drives and controls can be engineered in a user-friendly way using the SIZER for Siemens Drives engineering tool:

- SINAMICS Low Voltage and MICROMASTER 4 drive systems
- Motor starters
- SINUMERIK CNC control
- SIMOTION Motion Control System
- SIMATIC Technology

It provides support when selecting the technologies involved in the hardware and firmware components required for a drive task. SIZER for Siemens Drives supports the complete configuration of the drive system, from basic single drives to demanding multi-axis applications.

SIZER for Siemens Drives supports all of the configuring steps in a workflow:

- Configuring the power supply
- Designing the motor and gearbox, including calculation of mechanical transmission elements
- Configuring the drive components
- Compiling the required accessories
- Selecting the line-side and motor-side power options, e.g. cables, filters, and reactors

When SIZER for Siemens Drives was being designed, particular importance was placed on a high degree of usability and a universal, function-based approach to the drive application. The extensive user guidance makes using the tool easy. Status information keeps you continually informed about the progress of the configuration process.

The SIZER for Siemens Drives user interface is available in English, French, German, and Italian.

The drive configuration is saved in a project. In the project, the components and functions used are displayed in a hierarchical tree structure.

The project view permits the configuration of drive systems and the copying/inserting/modifying of drives already configured.

The configuration process produces the following results:

- A parts list of the required components (export to Excel, use of the Excel data sheet for import to SAP)
- Technical specifications of the system
- Characteristic curves
- Comments on system reactions
- Mounting arrangement of drive and control components and dimensional drawings of motors
- Energy requirements of the configured application

These results are displayed in a results tree and can be reused for documentation purposes.

Technological online help is available:

- Detailed technical data
- Information about the drive systems and their components
- Decision-making criteria for the selection of components
- Online help in English, French, German, Italian, Chinese and Japanese

System requirements

- PG or PC with Pentium III min. 800 MHz (recommended > 1 GHz)
- 512 MB RAM (1 GB RAM recommended)
- At least 4.1 GB of free hard disk space
- An additional 100 MB of free hard disk space on Windows system drive
- Screen resolution 1024 × 768 pixels (1280 × 1024 pixels recommended)
- Operating system:
 - Windows XP Home Edition SP2
 - Windows XP Professional 32 bit SP2
 - Windows XP Professional 64 bit SP2
 - Windows Vista Business
 - Windows 7 Ultimate 32 bit
 - Windows 7 Professional 32 bit
- Microsoft Internet Explorer V5.5 SP2

Selection and ordering data

Description	Article No.
SIZER for Siemens Drives engineering tool DVD-ROM English, French, German, Italian	6SL3070-0AA00-0AG0

More information

The SIZER for Siemens Drives engineering tool is available free on the Internet at:

www.siemens.com/sizer

SINAMICS G180

Configuring instructions

DT Configurator selection guide

Overview

Product description



The DT Configurator has been developed to assist with selection of drive train products from the product range. It is available as a selection guide offline within the Interactive Catalog CA 01 (DVD-ROM), and online in the Industry Mall. The DT Configurator makes it easier to find the correct drive solution. With the pre-selection, the product range can be restricted and the right product series determined. Converters can be selected according to the specific application.

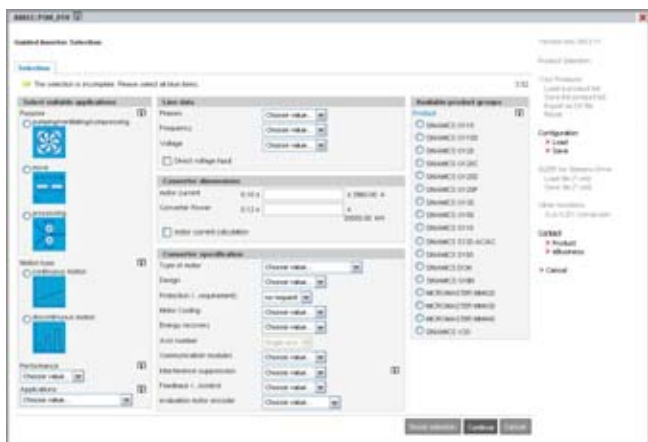

As well as the correct article number, the DT Configurator also immediately supplies the associated documentation.

SINAMICS Datenblatt für Umrichter SINAMICS G180
 Data sheet for inverter SINAMICS G180

MLFB-Nr.: 6SE0180-2ED06-3AA7

Elektrische Daten Motoreite / Electrical data motor side	
Leistungsbereich / Power range	0.37 - 110 kW
Spannungsbereich / Voltage range	0.4 - 230 V
Strombereich / Current range	0.5 - 200 A
... (other electrical data)

Mechanische Daten / Mechanical data	
Motorhöhe / Motor height	170 mm
Motorbreite / Motor width	110 mm
... (other mechanical data)

Umweltbedingungen / Ambient conditions	
Temperaturbereich / Temperature range	0 - 40 °C
... (other ambient conditions)

5

It can display operating instructions, factory test certificates, terminal box documentation, etc. and generates data sheets, dimensional drawings and a start-up calculation for the relevant products. It can also be used to identify a suitable converter for the selected motor.

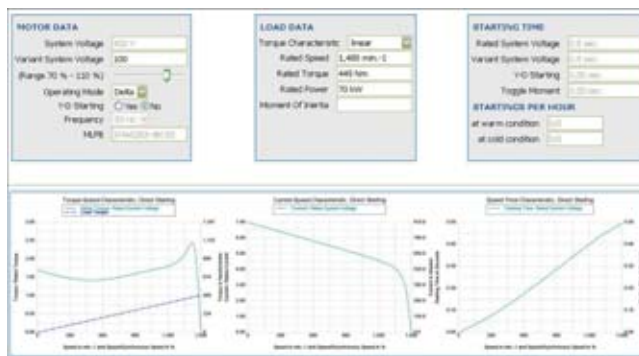

The comprehensive help system not only explains the program functions, but also provides access to detailed technical background knowledge.

Overview (continued)

DT Configurator – efficient drive configuration:

- Fast and easy configuration of drive components
- Configuration of drive systems for pump, fan and compressor applications ranging from 1 kW to 2.6 MW
- Wide range of products for selection
- Comprehensive documentation
- Support for retrofit applications
- Direct ordering via the Industry Mall

System requirements

- Internet access and standard browser (e.g. Internet Explorer V7.0 and higher, Firefox V5.0 and higher)
- Documentation (data sheets, dimension drawings, etc.) is output in PDF or RTF formats
- Registration is not required to use the DT Configurator

Offline access in the Interactive Catalog CA 01



The electronic catalog CA 01 on DVD-ROM – the offline version of the Siemens Industry Mall of Siemens Industry and Drive Technologies – contains over 100000 products with approximately 5 million possible drive system product variants.

The Catalog CA 01 can be installed as a light or full version from the DVD-ROM directly onto your hard disk or network. The DT Configurator can then be found in the main menu of the CA 01 under the "Selection guide" tab.

Online access in the Siemens Mall

In addition, the DT Configurator can be used on the Internet without requiring any installation. The DT Configurator can be found in the Siemens Industry Mall under the following address:

www.siemens.com/dt-configurator

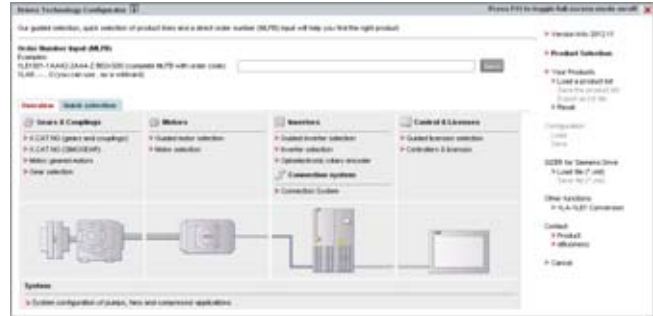

Selection and ordering data

Description	Article No.
Interactive Catalog CA 01 DVD-ROM including selection guide DT Configurator, German	E86060-D4001-A510-D3-7600

More information

Online access to DT Configurator

More information on the DT Configurator selection tool can be found at:

www.siemens.com/dt-configurator

Offline access to DT Configurator in the Interactive Catalog CA 01

The DT Configurator is also integrated into the Interactive Catalog CA 01 on DVD – the offline version of the Siemens Industry Mall.

The electronic catalog CA 01 can be ordered from the relevant Siemens sales office or via the Internet:

www.siemens.com/automation/CA01

SINAMICS G180

Configuring instructions

IMS commissioning tool

Overview

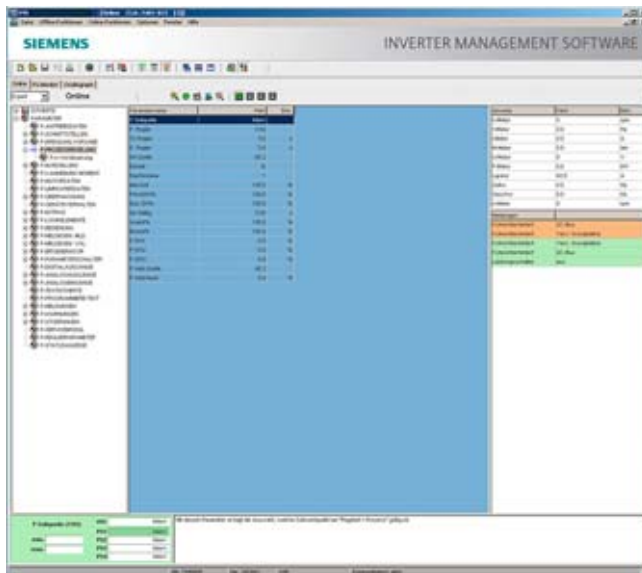

The Inverter Management Software (IMS) is the tool used to commission all versions of SINAMICS G180 drives.

This user-friendly tool is used to

- commission
- optimize and
- diagnose.

The clearly structured PC operating program supports PC-to-converter communication via USB, RS232, RS485, PROFIBUS DP or modem. A device identification function (IMS detects the firmware versions of connected drives) supports auto-adaptation to later firmware releases.

In order to ensure optimum operation and parameterization of the SINAMICS G180 converters, appropriate setting options are assigned to individual activities.

As a result, parameters are much easier to locate and the potential for making errors during commissioning, maintenance or servicing of the SINAMICS G180 converter is significantly reduced. The option of programming the unit in offline mode (no connection to the drive) facilitates local operation and reduces downtimes. The IMS also offers a comprehensive oscilloscope function which can be used for online and offline system diagnosis.

Functions

- Commissioning and operation with interactive menus
- Online/offline parameterization
- Terminal connection planning
- Convenient readout, storage and evaluation of internal status variables using the oscilloscope function
- Possibility of switching between parameter view and terminal strip view
- Function and message generators
- Extensive conversion and comparison functions
- Possibility of inserting comments for all function terminals and signals
- Management of data sets (upload, download, compare, print)
- ASCII import of all parameters for automatic generation of parameter sets
- Auto-adaptive software
- Plausibility check on parameter sets
- Detailed help texts for every parameter
- Import and export of parameter lists
- Online monitoring and condition control of converters
- Evaluation of fault messages and diagnostic information
- Available in 12 languages
- Simple firmware updates via RS232, RS485, USB, Ethernet or modem

Integration

SINAMICS G180 converters have a variety of different interfaces via which they can communicate with the Inverter Management Software or other peripheral partners (PCs, PLCs, various communication/control devices, etc.)

Apart from the standard USB interface (connection with one partner), an RS232/485 interface is also provided as standard, which permits simultaneous communication and control with several nodes. These interfaces can also be accessed by means of a modem, USB converter or Ethernet converter and therefore provide a basis for setting up a multi-Ethernet connection, for example, between up to 10 converters.

The SINAMICS G180 has also been equipped with a USB interface which can be connected directly to a PC or laptop. As an option, the SINAMICS G180 can also be supplied with a PROFIBUS interface. With this option installed, the IMS is capable of implementing "master class 1" as well as "master class 2" operation.

Selection and ordering data

	Article number
Inverter Management Software (IMS) For SINAMICS G180 on CD Available languages: Chinese, Czech, English, French, German, Hungarian, Norwegian, Polish, Portuguese, Russian, Spanish and Swedish	LDX: L0352441



Accessories

	Article number
For USB interface USB cable (A-B), 5 m USB cable (A-B), 2 m	LDX: L0330601 LDX: L0296421
For PROFIBUS interface USB cable (A-B), 2 m USB interface for PROFIBUS (option G13) Ethernet-PROFIBUS gateway (option G14)	LDX: L0296421 LDX: L0327420 LDX: L0327419
Power supply unit for Ethernet-PROFIBUS gateway (included with option G14 if gateway is installed in the converter cabinet)	LDX: L0176345

More information

The Inverter Management Software for SINAMICS G180 can be obtained free of charge from Siemens Customer Support or downloaded at no cost from the following website:

<http://support.automation.siemens.com/WW/view/en/31994919/133100>

SINAMICS G180

Configuring instructions

Notes

5



6/2	Customer training
6/2	Overview
6/2	General information
6/2	SINAMICS G180 customer training
6/2	Miscellaneous
6/3	Commissioning of SINAMICS G180
6/3	Overview
6/3	Our services
6/3	Your advantages at a glance
6/4	Maintenance and inspection of converters
6/4	Overview
6/4	Our services
6/4	Your advantages at a glance
6/4	Service at Headquarters
6/5	Repairs at Headquarters
6/5	Overview
6/5	Service at Headquarters
6/6	Spare parts for SINAMICS G180 converters
6/6	Overview
6/6	Spare parts packages on site
6/6	Spare parts information and database
6/6	Your advantages at a glance
6/6	Service at Headquarters
6/7	Remote maintenance – Expert knowledge close at hand
6/7	Overview
6/7	Our services
6/7	Your advantages at a glance
6/8	Documentation
6/8	Overview
6/8	Manual
6/8	For compact devices
6/8	For ETO converters
6/8	Converter documentation
6/9	Service & Support
6/9	Your machines and equipment can do more – with Industry Services from Siemens.
6/10	Industry Services for the entire life cycle
6/10	Online Support
6/10	Technical Support
6/10	Spare Parts
6/11	Repair Services
6/12	Field Services
6/13	Training
6/13	Technical Consulting & Engineering Support
6/14	Energy & Environmental Services
6/14	Plant Maintenance & Condition Monitoring
6/15	Service Contracts
6/16	Water Related Services
6/16	Modernization & Optimization Services

SINAMICS G180

Services and documentation

Customer training

Overview

General information

Structure of our courses

Our courses are intended for practitioners, so they are structured using examples from everyday practice. The trainers adapt to the prevailing knowledge level of the participants and build on this.

Course components

The following services are included in the price of the course:

- Training in small groups in the specified course language
- Comprehensive course notes
- IMS (Inverter Management Software)
- Other necessary documents in digital form
- RS232 cable, USB adapter, as required
- Food and drink during the lunch and coffee breaks
- Course completion certificate listing the main contents of the course

Would you prefer other training locations/dates?

On request, we would be happy to conduct courses at your premises. Please contact us with regard to additional course dates.

SINAMICS G180 customer training

Course objective	<ul style="list-style-type: none"> • Getting to know the functions of a frequency converter • Correct commissioning • Diagnostics and description of faults • Rectification of faults
Contents	<ul style="list-style-type: none"> • Introduction to converter technology • Application examples for SINAMICS G180 • SINAMICS G180 theory, power unit and signal flow chart • SINAMICS G180 practice, commissioning, setting up and optimization • Diagnostics and rectification of faults
Target group	Those involved in development, configuration, plant support, service and installation
Duration	2 days (08.00 to 16.00 hrs)
Dates	Available from your local Siemens contact
Location	Hans-Loher-Str. 32, 94095 Ruhstorf, Germany
Fees	On request
Number of participants	Maximum 6
Course language	English or German

Miscellaneous

It would be beneficial if the participants brought their own laptops.

System requirement: Windows 2000/XP/7

Registration

Please send in your registrations at least four weeks before the seminar begins marked "SINAMICS G180 customer training" together with the desired date and any room reservation requirements to:

Siemens Werk Ruhstorf
Postfach 1164
94095 Ruhstorf, Germany

Tel.: +49 (8531) 39 554
Fax: +49 (8531) 39 569

Email: driveservice.rhf.de@siemens.com

Following confirmation by Siemens, the registration is binding for both parties. The number of course participants is limited. Registrations will be processed in order of receipt. Technical processing and scheduling will be undertaken by Siemens Ruhstorf. Commercial processing will, however, be via your regional Siemens office. We therefore require an order that is addressed to your regional Siemens office.

Cancelation of the registration by the participant

If the registration is canceled more than one week before the seminar starts, 50 % of the fees will be charged. This will not apply if the participant is replaced by another employee of the same company.

Cancelation/postponement by the organizer

Siemens reserves the right to cancel or postpone seminars for organizational reasons or in case of insufficient registrations.

Accommodation

Siemens can reserve a room for you in a neighboring hotel for the duration of the seminar, if required. Please provide your time of arrival and departure in this case. The hotel bill must be paid directly by the participant or their company.



Overview



Your advantages at a glance

- High degree of flexibility and cost advantages thanks to a global network of qualified service personnel
- Direct contact between customers and manufacturer, in close collaboration with local service centers
- Short communication paths across all organizational levels
- "Global resource management" for worldwide service callouts, taking into account legal and tax-related directives
- Cross-functional drive expertise for the complete system
- Highly qualified specialists for variable-speed drives

Our services

Commissioning and on-site servicing of converters – including auxiliary equipment and built-on components for variable-speed drives up to 6 MW in the low-voltage range.

With the emphasis on the following industries

- Oil and gas
- Chemical industry
- Energy
- Shipbuilding
- Mining
- Cement
- Water and wastewater
- Wind energy
- Auxiliaries:
 - Water cooling systems
 - Oil cooling systems
 - Higher-level control systems
 - Protective equipment
 - Static excitation units/excitation converters
 - Transformer protection

SINAMICS G180

Services and documentation

Maintenance and inspection of converters

Overview



Our services

Inspection

- Recording and determining the actual condition of converters
- Comprehensive product examination based on a checklist
- Definition of additional measures required, including a report
- Service portfolio

Maintenance contracts

- Definition of the required maintenance intervals
- Remote support and availability of a technical contact person
- Agreements regarding inspection dates, spare parts, service materials and tools
- Training of the customer's service personnel

Your advantages at a glance

Inspection

- Assessment of the actual situation, measurements and diagnostics corresponding to the checklist
- Determination of the required maintenance work
- Recommendation for an optimum range of spare parts to be stocked
- Investigation of the possibilities for improving the operating conditions

Maintenance

- Maximizing the drive lifetime
- Minimizing component wear
- Avoiding non-scheduled production failures and the associated costs
- Monitoring the product life cycle and providing support on alternatives

For further information, please contact:

www.siemens.com/ld-service

Service at Headquarters

Tel. +49 (8531) 39-554

Fax +49 (8531) 39-569

Email: driveservice.rhf.de@siemens.com

Overview



We also offer repairs and regular maintenance at our repair center. The repair and maintenance services cover all the necessary measures for restoring faulty units as well as their functionality.

Following repair, a report will be generated and a comprehensive device test will be performed. The load machines of the series test bay can be used to perform these device tests and to create the repair test report.

When equipment is returned for repair, to save time, the following information should be specified in the accompanying letter.

1. Contact partner, with fax and phone number and, if possible, email address
2. Details of the device to be repaired: type, device number, quantity, article number, date of dispatch, requested date of return, date of failure
3. Type of fault determined (e.g. fault message output, transport damage, etc.)
4. Type of processing required for repair order (e.g. supply of replacement, repair, cost estimate, inspection only)
5. Additional information about the failure (e.g. failure pattern, ambient conditions, any available measurements or oscillographs).

In urgent situations, to allow the plant to be returned to operation as quickly as possible, we also offer a fast repair service.

If required, we would be pleased to provide the customer with a repair cost estimate.

If it is determined that a repair is uneconomical, the customer will be informed and the repair will be canceled. As an alternative, a new device will be offered.

For further information, please contact:
www.siemens.com/lc-service

Service at Headquarters

Tel. +49 (8531) 39-554

Fax +49 (8531) 39-569

Email: driverepair.rhf.de@siemens.com

SINAMICS G180

Services and documentation

Spare parts for SINAMICS G180 converter series

Overview



Spare parts packages on site

For drives which often play an essential role as main drives, in addition to general service requirements, the availability of spare parts is of crucial significance.

Apart from the individual spare parts, we are also able to offer complete spare parts packages – originating from device-specific spare parts overviews. These have been generated from our extensive service experience gained through the maintenance and troubleshooting of drives and components.

Various spare part packages are available for all our devices:

- Basic Spare Package: contains the most important electronic components, e.g. for commissioning and the running-in period.
- Advanced Spare Package: contains additional electronic power components to ensure the availability of the drive over the first five years in operation.

Spare parts information and database

By specifying the Siemens article number (converter type number or article number) and the corresponding serial number, you can download spare parts information for almost every current drive from a database from → **Spares On Web**:

You can view a basic list of the spare parts for your device on the Internet. All you need to enter is the Siemens article number and the associated serial number, e.g.:
6SE0100-1AH21-0AA7 & 7392665

or

the converter type and the associated serial number: e.g.:
2T2A-07600-007 & 7392665.

www.siemens.com/sow

Your advantages at a glance

- Minimization of fault-related downtimes
- In the case of a fault, no additional waiting times for spare parts to be delivered
- Increased availability of the drive unit
- Cost advantages by compiling spare part packages
- Individual package content corresponding to customer and plant requirements during the entire life cycle.

General note:

There is a necessary minimum of information that must be supplied to ensure that the correct spare part is supplied. In the order, the device number (e.g. 7370300) and the device type (e.g. 2T2A-83500-027) must generally be specified for which the spare part is required. If the spare part is intended to be stocked for several devices, it is recommended that the device types of the converters concerned are specified.



For further information, please contact:

www.siemens.com/ld-service

Service at Headquarters

Tel. +49 (8531) 39-554

Fax +49 (8531) 39-569

Email: drivespares.rhf.de@siemens.com

Overview



Our services

Complex drive systems must have a high availability and, if required, demand competent and fast support. Specialist personnel cannot always be available locally. This is the reason why we offer you the option of remotely monitoring your plants or systems.

Remote maintenance activities such as these include, for example, the following services:

- Online condition monitoring
- Data is stored so that it cannot be lost in the event of a power failure
- Trend analysis, archiving and comparison of the saved data
- If required, expert support from the local service organization
- Video-based support for plant personnel
- Definition of additional measures required, including a report

Your advantages at a glance

Remote maintenance

- Best technology on the market for high-security connections with maximum availability
- Variety of supported software applications
- Best remote maintenance platform in the industry
- Support service available around-the-clock
- Transparency through monitoring and signaling of all connections

Condition monitoring

- Minimizing non-scheduled plant downtimes and avoiding subsequent costs
- Increased plant availability
- Basis for condition-based maintenance
- Optimization and planning of service and maintenance work
- Resource-saving handling of materials as an important contribution to environmental protection
- Optimization of the spare part inventory
- Graded, versatile hardware and software concepts → scalable and flexibly adaptable to the relevant drive system

SINAMICS G180

Services and documentation

Documentation

Overview

Manual

- Manual (PDF format, single language):
 - Safety instructions
 - Device overview
 - Application planning
 - Mechanical installation
 - Electrical installation
 - Commissioning
 - Operation
 - Setpoint channel and closed-loop control
 - Connecting terminals
 - Diagnostics, faults, maintenance and servicing
 - Technical data, certificates
- Certificates (included in the manual):
 - EC Declaration of Conformity for the Low-Voltage Directive and EMC Directive
 - Declaration of incorporation according to the EC Machinery Directive
 - Declaration of Conformity, STO SIL 2
 - Declaration of Conformity, PTC input SIL 1
 - Ex certificate for PTC evaluation to ATEX (prototype test certificate)

For compact devices

The documentation for compact devices is supplied as standard on a CD as follows:

- Manual (English/German)
- Inverter Management Software (IMS)
- Parameterization guide (in German only)
- Message texts of the converter
- Data sheets of the converters
- Data sheets of optional equipment

For ETO converters

The converter documentation will be supplied by email in PDF format (English/German) as preliminary documentation 6 or 7 weeks after order clarification.

The final documentation for configured converters will normally be sent by email in PDF format (English/German) 1 or 2 weeks after dispatching the converter.

A different document format can be ordered if required (see Option descriptions).

Note:

Please contact your Siemens partner in the sales office if you require documentation in a different language.

A CD containing the following is enclosed with every ETO converter:

- Manual (English/German)
- Inverter Management Software (IMS)
- Parameterization guide
- Message texts of the converter
- Data sheets of the converters
- Data sheets of optional equipment

Converter documentation

- Set of diagrams, as follows:
 - Cover sheet and table of contents of converter documentation (customer, project number, article number, serial number, type)
 - Technical data of the equipment, type data
 - Installation diagrams (dimension sheet, cross-sectional view, labels, equipment type plate, internal view, mounting plate)
 - Terminal diagrams (line connection, CB08 control plate, peripheral board, converter output, motor connection, internal terminals, controller)
 - Circuit diagram (infeed (where applicable, also with transformer), converter, motor, control voltage, digital inputs and outputs, analog inputs and outputs, D-sub connections, I/Os and any other options, such as a local control box)
 - Parts list
- Acceptance test certificate (PDF format)
- List of parameters, set according to customer requirements (PDF format, single language)

Optionally available:

- Specific maintenance/servicing instructions
- List of recommended spare parts
- Acceptance report enclosed with the acceptance options **F71, F73, F81, F83 and F85**

Overview

Your machines and equipment can do more – with Industry Services from Siemens.



Whether in the manufacturing industry or in the process industry – high cost pressure, rising energy prices and increasingly stringent environmental requirements mean services for industry have become a decisive factor for success in the competitive environment.

Siemens supports its customers worldwide with product, system and application-oriented services over the complete life cycle of a plant. Customers also profit through these services from the comprehensive technology and product know-how and industry expertise of the Siemens experts – from planning and development, through operation, as far as modernization.

Downtime is reduced and the use of resources is optimized. The result: improved productivity, flexibility and efficiency coupled with lower overall costs.

Discover all the advantages of our service portfolio: www.siemens.com/industry-services

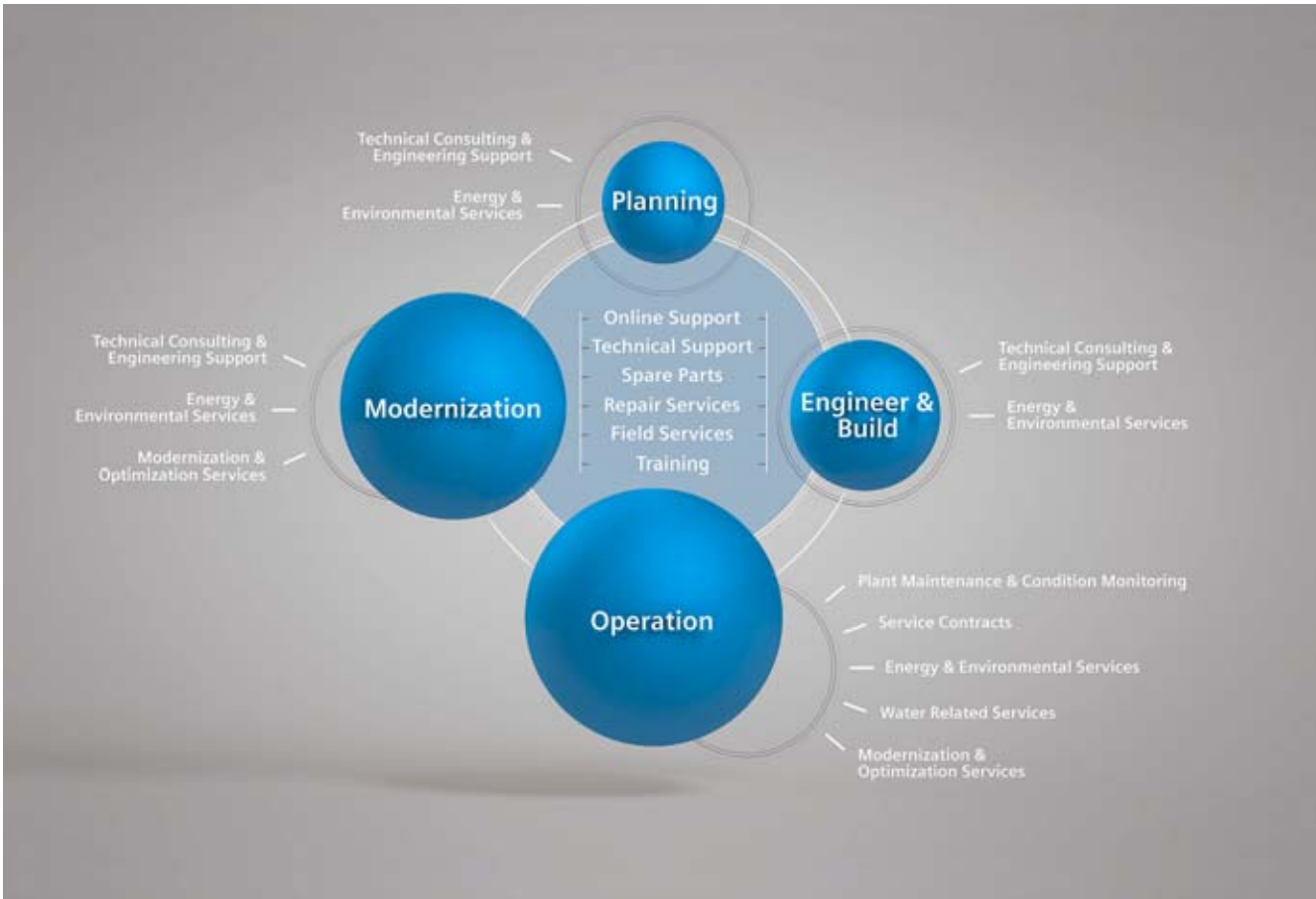

Siemens supports its customers with technology-based services over the complete life cycle of a plant.

SINAMICS G180

Services and documentation

Industry Services
for the entire life cycle

Overview

Online Support:



Fast access to technical information for all the products of Siemens Industry in the form of manuals, FAQs and application examples makes it unnecessary to contact an expert in most cases.

Technical Support:



The Siemens Industry Online Support also provides a platform for exchanging information with other users.

Industry Online Support gives you direct, central access to in-depth information concerning products, systems and applications for industry. You will find numerous programming, configuration and application examples here too. The content is available in six different languages and can be accessed anywhere thanks to a mobile app. The Technical Forum of Online Support provides the opportunity for users to swap information. The Support Request function allows contact to be established with Siemens experts in Technical Support. Siemens Industry Online Support ensures that users in industry are always kept up-to-date with news, software updates and announcements by means of newsletters and Twitter.

www.siemens.com/industry/OnlineSupport

Technical queries regarding products and systems can arise at any time – ranging from optimizing use to rectifying faults. The Technical Support specialists provide the relevant support round-the-clock and will answer questions about the functionality and operation of products and systems.

<http://support.automation.siemens.com/WW/view/en/16605032>

Spare Parts:



A missing spare part can adversely affect plant availability and cause production failures. It is good that the experts from Siemens ensure a fast and smooth exchange process.

Spare parts and spare parts packages for electric motors and converters

The global Siemens service organization and the maintenance-friendly design of Siemens machines permit a short response time and immediate replacement of faulty individual components. Siemens Industry Services ensures fast availability of standard spare parts. Delivery times for individual manufacturing vary according to the production overhead.

Siemens Industry Services process all inquiries as quickly as possible to the satisfaction of customers. Delivery times cannot always be precisely planned due, for example, to country-specific customs regulations, and some parts need to be specially manufactured, so it is recommended that important spare parts and core components are stocked on site to ensure a fast response. Any costs associated with failures can also be minimized by stocking a spare parts package on site.

Spare parts packages for electric motors

To simplify stockkeeping as far as possible, for general industrial machines and especially for machine tools (e.g. 1PH7, 1PH8 and 1PL6), Siemens offers spare parts packages that have been assembled specifically for the respective motors. Spare parts packages are also available that are individually tailored to the plant, as well as individual spare parts for special purposes.

Spare parts packages for converters

In the medium-voltage range in particular, converters are often an essential component of the main plant drive. Their functional capability is the prerequisite for reliable plant operation. Optimum availability of spare parts is also important to minimize downtimes.

Overview (continued)

Apart from individual spare parts, Siemens also offers complete spare parts packages. These are based on the extensive service experience of the company and have been put together on the basis of device-specific spare part lists. Siemens provides various versions of spare parts packages for low-voltage and medium-voltage units:

- Basic Spare Package: contains the most important electronic components, e.g. for commissioning and the running-in period.
- Advanced Spare Package: contains additional electronic power components to ensure the availability of the drive over the first few years in operation.
- Premium Spare Package: contains all the spare parts required to rectify almost every fault scenario as quickly as possible over the entire product life cycle. In the context of annual maintenance, the spare parts stocks can be checked and individually restocked.

Repair Services:



Reliably operating motors and converters have highest importance in every plant.

To allow you to always work with maximum efficiency, the Siemens specialists throughout the world provide a comprehensive maintenance service and handle any necessary repairs.

All-round service for electric motors and converters

With tailor-made services for electric motors and converters, Siemens Industry Services enables you to achieve high levels of efficiency and smooth production processes. The services comprise all the measures required for maintenance, but also provide support with planning, installation and commissioning.

Thanks to extensive consultation, the services will match your individual requirements perfectly. Siemens Industry Services performs all work exclusively in its own workshops or through certified partners. The all-round service for electric motors and converters comprises:

- Three-phase machines
- Three-phase servo machines
- High-voltage machines
- Direct-current machines
- Direct-current servo machines
- Emergency power units
- Generators
- Special-purpose machines
- Circuit breakers
- Frequency converters
- Lubrication and cooling systems
- Mechanical components (couplings, gear units)

Spares On Web – the information tool for spare parts and spare parts packages

Siemens offers comprehensive spare part information for almost all current converters and motors in an online database. The Siemens article number and the corresponding serial number are all that are required to call up this information.

www.siemens.com/sow

The service portfolio of Siemens Industry Services:

- Inspection, measurement, monitoring, evaluation, documentation, consultation
- Maintenance on site or in the service workshop including the exchange of wear parts, mechanical and electrical diagnosis
- Removal and installation of machines, laser-optic alignment and commissioning
- Special cleaning and drying procedures
- Corrective maintenance of stator and rotor cores, including new windings
- Measurements for partial discharge, loss factor and vibration; thermography, frequency analysis, oil analysis, assessment reports, diagnostics and special examinations
- Mounting of diagnostic devices for the continuous acquisition of operating and status data or trends, and causes of faults at constant and variable speed
- Mechanical and electrical load tests and simulations
- Spare parts packages, supply of spare parts and stock management
- Reproduction under license and upgrades for electric machines and components
- Collection, delivery and the supply of tools

As an experienced, reliable partner for the maintenance of electric machines, Siemens offers a full range of services from a single source. This simplifies processes and makes it easy to access services and spare parts. Repair times are shortened and optimized, and the availability of the plant is permanently enhanced.

SINAMICS G180

Services and documentation

Industry Services
for the entire life cycle

Overview (continued)

Field Services:



Downtimes must be avoided wherever possible. Field Services from Siemens ensures smooth commissioning and maintenance, and, if necessary, ensure the fast troubleshooting of industrial plants.

Field services for reliable drives

Commissioning and maintenance on site range from simple fault rectification to comprehensive, tailor-made service contracts. Specialists from Siemens Industry Services are available round-the-clock at strategic locations worldwide to provide fast and reliable support with fault rectification in plants as well as with normal operation of the products and systems from Siemens. All service calls are scheduled and coordinated by the responsible regional service coordination center in accordance with customer requirements. This responsibility also extends to an emergency service outside normal working hours.

The service portfolio for commissioning machines, converters and complete plants comprises, for example:

- Check of the installation
- Function tests
- Parameter assignment
- Integration tests for machines and machine parts
- Trial operation
- Final acceptance
- Training of personnel

Siemens Industry Services also offers periodic inspections, preventative maintenance schedules and predictive maintenance measures in close cooperation with the customers tailored to their own specific criteria.

Commissioning by specialists

The experienced, qualified service staff of Siemens Industry Services have specialized in commissioning state-of-the-art, complex drive systems and also have access to expert knowledge of cross-industry applications and projects within the global service network. This creates the required flexibility for a wide variety of different application cases. The central focus is on solutions for fixed-speed and variable-speed low-voltage and medium-voltage drives/motors up to 100 MW, as well as auxiliary drives of all types in the oil & gas, chemical, energy, steel, paper, shipbuilding, mining, cement, water & wastewater and wind power industries.

Winding testing by means of diagnostic measuring and test methods

Qualified tests of the motor winding for polarization, insulation resistance, loss factor and partial discharge play an important role in ensuring fault-free operation and the availability of high-voltage machines over the entire life cycle of the plant. With modern portable measuring equipment and qualified evaluations, these tests and diagnostics can now also be performed on site. In the case of Siemens machines, archived measured values obtained from production and quality assurance are also available for this purpose.

Overview (continued)

Training:



Against the background of rapid technological progress, up-to-date know-how is increasingly becoming a decisive factor for success.

The technical seminars and training courses that Siemens offers with SITRAIN – Training for Industry impart expert know-how and practical knowledge directly from the manufacturer. Nobody knows more about this subject than us.

Customer-specific training for electric motors and converters

A competent, qualified team of operating and maintenance personnel can be established and trained if the right systems are in place. Siemens Industry Services supports its customers with tailored courses and training measures. This is where specialist know-how is passed on.

Course content

The course content is adapted to the prevailing knowledge of the customer's personnel and the drive technology implemented.

1. Basic technical training

- Fundamentals of drive technology
- Basic functionality of electric motors and converters
- Structure and main components of electric motors and converters

Technical Consulting & Engineering Support:



2. User and operator training

- Efficient operation and monitoring of electric motors and converters
- Limit value monitoring, taking into account alarm and fault messages, and fault rectification measures

3. Instruction on site

- Planning and performing on-site maintenance tasks
- The correct response in the event of faults or if alarm messages are output
- Initial investigation and determination of the causes of faults
- Removal and rectification of faults
- Contacting the Siemens service organization with a precise description of the fault
- Appropriate selection and stocking of spare parts

Method

Modern learning aids and practical training units ensure that learning targets are achieved efficiently. Course tutors with many years of own experience in the implementation of efficient drive technology in various industries are able to communicate this know-how with in-depth, background information. In close cooperation with the customers, all measures are adapted to their specific requirements and wishes.

1. On-site training at customer's premises in the form of a workshop

- The training will take place on the original drive or equipment
- It can also be conducted for products that are no longer in the current product range

2. Training in the Siemens factory

- The training takes place in the relevant Siemens production facility
- Practical training on demonstration models
- Optional factory tour with demonstration of the Siemens product range
- Opportunity to meet the contact partners at Siemens Industry Services and exchange personal experiences

3. Course duration

- Depending on requirements 1 to 5 days

The foundations for efficient processes in industry are laid at the plant planning and design stages. Systematic solutions are required here that take the complete life cycle into consideration. Technical Consulting & Engineering Support from Siemens offers industry exactly the right instruments – from the initial configuration steps through to plant operation.

SINAMICS G180

Services and documentation

Industry Services
for the entire life cycle

Overview (continued)

Energy & Environmental Services:



Constant energy-saving and environmentally aware action pays off for every company. Energy efficiency, energy management and saving resources are hot topics in industry today. The integrated solutions from Siemens open up all the technical and organizational potential for efficient and successful environmental management.

Saving energy in drives

The decisive factor in achieving the most energy-efficient solution is to reduce energy consumption to that actually required by the application. The plan will involve a comprehensive bundle of measures. The costs and benefits of possible savings are weighed against each other, the drive components are configured according to the requirements, and the ideal plan to ensure sustainable implementation of the overall concept is formulated. Siemens Industry Services offers full support for this process, including qualified consulting, engineering and project management from drive specialists with many years of experience in almost all branches of industry. This saves time and minimizes the overhead for binding personnel in the company to specific projects.

The scope of these energy optimization measures covers three phases:

1. Identification of potential savings

The energy requirement is determined and potential energy savings are highlighted.

- Identification of the existing energy consumption of the plant
- Presentation of the energy flow and potential savings
- Output measurement and assessment of the quality of the line supply
- Analysis of electric motors in terms of their utilization and energy efficiency
- Recording energy costs to determine the potential energy savings

2. Evaluation of the data obtained

The potential savings identified are evaluated using various methods, so that a sound basis for decision-making is created.

- Inclusion of experience gained from comparable plants through comparison with known application cases
- Calculation of the potential savings using the energy efficiency software SinaSave
- Determining the investment costs taking into account the service life, amortization and feasibility
- Specification of measures and suggested solutions

3. Implementation of the energy optimization measures

The right products and targeted implementation measures are determined and implemented.

- Selection of the right components
- Retrofitting and modernization of plant sections
- Assistance with ordering
- Project management and processing
- Engineering, configuration, setting up, modifications, assembly, installation, commissioning, acceptance and training
- Assessment of results after a specified period

Plant Maintenance & Condition Monitoring:



Plant efficiency and problem-free processes are decisive factors for success in industry.

Proactive maintenance concepts and individually tailored service contracts that are based on the wide-ranging experience built up by Siemens experts ensure maximum productivity.

Overview (continued)

Service Contracts:



A service contract ensures the high level of reliability that you simply need today in industry. Tailored service packages for the maintenance ensure minimal downtimes and reduce the maintenance budget. The possibilities of remote maintenance ensure an additional valuable reliability plus.

Modular service contracts for electric motors and converters

Individually agreed service contracts make the maintenance, optimization and modernization of automation and drive technology in industry more efficient and dynamic coupled with reduced costs. Flexible options, such as extended service periods, defined arrival times and special maintenance intervals or remote maintenance can be defined to meet your specific requirements. In combination with the extensive experience and know-how of maintenance and service specialists from Siemens Industry Services, you can achieve reduced downtime, plannable operating costs and a high availability of all machines and equipment.

Maintenance contracts for motors and converters

Reliable motors and converters are the core of every industrial plant. With uninterrupted duty and poor environmental conditions (dirt, dust and aggressive atmosphere), individual components such as pulse encoders, roller bearings and fans are subject to greater wear: whereby small-scale local damage, such as a reduction in insulation resistance, can cause considerable secondary damage. To prevent this, maintenance contracts from Siemens offer fixed maintenance and service intervals in which the status of all components can be checked by specialists and critical components can be replaced. The corresponding documentation and product-specific checklists help to perform all the relevant investigations at the right time and achieve optimum availability.

The maintenance contract also includes a comprehensive consultation with a view to maximizing plant availability and assessing the contribution that could be made by conversion and refitting in the area of drives. In parallel with this, Siemens ensures with plant-specific instructions during on-site service that plant operators are able to reliably master all operations and simple maintenance tasks. Siemens also offers more advanced training courses with the objective of preventative maintenance. When the maintenance contract is drawn up, the customer profits from comprehensive advice and numerous, optional services:

- Defined product support/maintenance
- Training (basic and advanced)
- Remote services and condition monitoring
- Plant support remotely by telephone
- Specified support times (response, arrival and service times)
- Customized spare parts packages on site
- Defined costs

Remote Services – expert knowledge within your grasp

Remote Services can be integrated into service contracts as an optional service. The Remote Service platform from Siemens (cRSP) has set new standards in IT security, traceability and flexibility. This also enables complex drive systems to be monitored, analyzed and optimized if required by means of remote access from Siemens drive specialists efficiently and reliably. The breadth of supported services ranges from reading the archived log and analyzing stored data through online condition monitoring for motors and software updates as far as video support with service work on site.

Condition Monitoring – for condition-based maintenance

With Siemens service contracts, it is possible to select condition monitoring for central drive components and those subject to wear as an optional service. This means that irregularities in operation can be detected at an early stage so that countermeasures can be initiated and service work can be planned more efficiently. In the case of motors, the emphasis is on the monitoring of vibration, winding and bearing temperatures as well as speed. In the case of frequency converters, monitoring is concentrated on current, voltage and power, cabinet temperature, water temperature and heatsink temperature, fault pattern and communication.

SINAMICS G180

Services and documentation

Industry Services
for the entire life cycle

Overview (continued)

Water Related Services:



Impeccable water quality is important for a large number of industrial processes. The production of extremely pure water is therefore essential for many companies. Industry is also required by law to process the waste water that it produces. Siemens Water Related Services ensure that water systems are efficient and environmentally friendly which also assures sustained corporate success.

Modernization & Optimization Services:



Enhancements, modernizations and optimizations of production are on industry's agenda. They are the most economical keys to achieving optimum productivity in industrial manufacture and to assuring long-term investment protection. It is good to know that Siemens also offers competent service in these areas.

Modernizing and optimizing electric motors and converters

The modernization of electric motors and converters – also known as retrofitting – constitutes a major part of their product life cycle. Retrofits serve to protect investments. They optimize the availability, reliability and energy efficiency of installed drives. The latter also has a beneficial effect on the environmental impact of the company. Retrofits often lower the original noise level and thus improve the working environment. Siemens Industry Services offers an extensive retrofit program for both Siemens and non-Siemens products. This program ranges from simple conversions and upgrades through replacement of individual components as far as project management for complex retrofits. Once all the upgrade options have been exhausted, old technologies can be replaced with state-of-the-art drives and motors from the current product range. Under normal circumstances, neither method requires the functional scope of the plant to be expanded or a change in the basic drive concept.

Modernization and optimization of electric motors:

- Replacement of constant-speed motors with variable-speed drives
 - Energy saving
 - Increased productivity and profitability
- Functional replacement using new products
 - Adaptation to existing equipment at low cost
 - Energy saving through improved efficiency
- Reproduction of older motors under license
 - No complex requalification necessary
 - 1:1 replacement possible

Modernization and optimization of converters:

- Replacement of older converters with innovative models in the low-voltage and medium-voltage range
- Service benefits:
 - Assured supply of spare parts worldwide
 - Access to the latest know-how
 - State-of-the-art diagnostics
 - Easier software updates
- Renewal of the control electronics
- Retrofitting of water-cooled heat exchanger units

Appendix



7/2	Partners at Industry Automation and Drive Technologies
7/3	Online Services
7/3	<u>Information and Ordering in the Internet and on DVD</u>
7/3	Siemens Industry Automation and Drive Technologies in the WWW
7/3	Product Selection Using the Interactive Catalog CA 01 of Industry
7/3	Easy Shopping with the Industry Mall
7/4	<u>Information and Download Center, Social Media, Mobile Media</u>
7/5	Subject index
7/9	Article number index
7/11	Metal surcharges
7/14	Conditions of sale and delivery

SINAMICS G180

Appendix

Partners at Industry Automation and Drive Technologies



At Siemens Industry Automation and Drive Technologies, more than 85 000 people are resolutely pursuing the same goal: long-term improvement of your competitive ability. We are committed to this goal. Thanks to our commitment, we continue to set new standards in automation and drive technology. In all industries – worldwide.

At your service locally, around the globe for consulting, sales, training, service, support, spare parts ... on the entire Industry Automation and Drive Technologies range.

Your personal contact can be found in our Contacts Database at: www.siemens.com/automation/partner

You start by selecting a

- Product group,
- Country,
- City,
- Service.



Siemens Industry Automation and Drive Technologies in the WWW

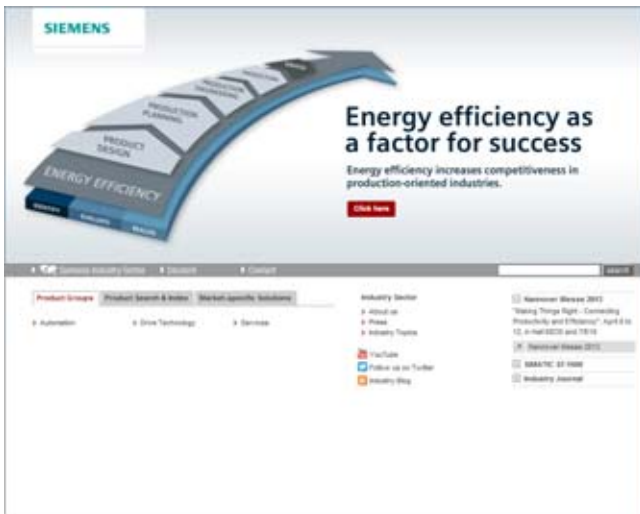

A detailed knowledge of the range of products and services available is essential when planning and configuring automation systems. It goes without saying that this information must always be fully up-to-date.

Siemens Industry Automation and Drive Technologies has therefore built up a comprehensive range of information in the World Wide Web, which offers quick and easy access to all data required.

Under the address

www.siemens.com/industry

you will find everything you need to know about products, systems and services.

Product Selection Using the Interactive Catalog CA 01 of Industry



Detailed information together with convenient interactive functions:

The interactive catalog CA 01 covers more than 80 000 products and thus provides a full summary of the Siemens Industry Automation and Drive Technologies product base.

Here you will find everything that you need to solve tasks in the fields of automation, switchgear, installation and drives. All information is linked into a user interface which is easy to work with and intuitive.

After selecting the product of your choice you can order at the press of a button, by fax or by online link.

Information on the interactive catalog CA 01 can be found in the Internet under

www.siemens.com/automation/ca01

or on DVD.

Easy Shopping with the Industry Mall

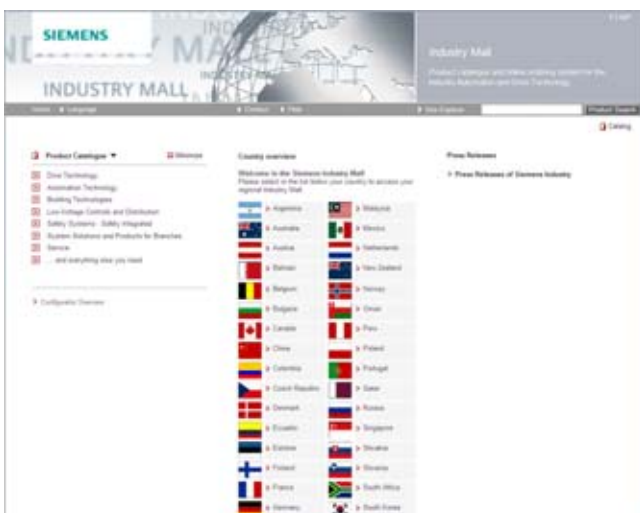

The Industry Mall is the virtual department store of Siemens AG on the Internet. Here you have access to a huge range of products presented in electronic catalogs in an informative and attractive way.

Data transfer via EDIFACT allows the whole procedure from selection through ordering to tracking of the order to be carried out online via the Internet.

Numerous functions are available to support you.

For example, powerful search functions make it easy to find the required products, which can be immediately checked for availability. Customer-specific discounts and preparation of quotes can be carried out online as well as order tracking and tracing.

Please visit the Industry Mall on the Internet under:

www.siemens.com/industrymall

SINAMICS G180

Appendix

Online Services – Information and Download Center Social Media, Mobile Media

Downloading Catalogs

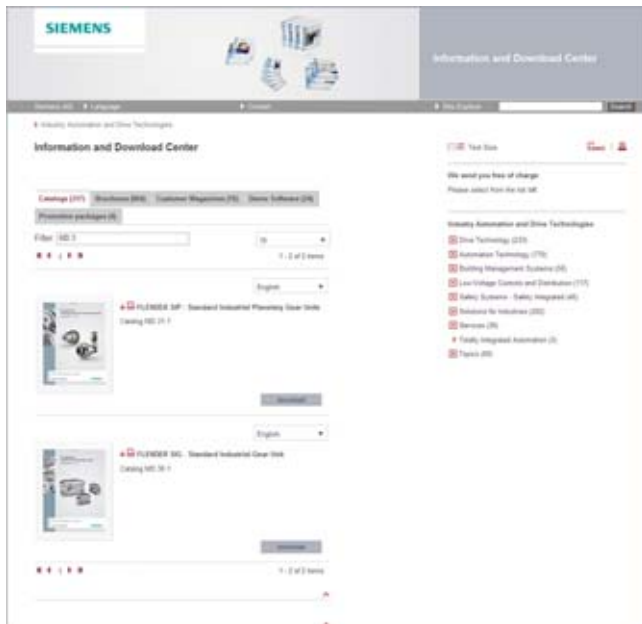

In addition to numerous other useful documents, you can also find the catalogs listed on the back inside cover of this catalog in the Information and Download Center. Without having to register, you can download these catalogs in PDF format or increasingly as digital page-turning e-books.

The filter dialog box above the first catalog displayed makes it possible to carry out targeted searches. If you enter "MD 3" for example, you will find both the MD 30.1 and MD 31.1 catalogs. If you enter "ST 70" both the ST 70 catalog and the associated news or add-ons are displayed.

Visit us on the web at:

www.siemens.com/industry/infocenter

Social Media

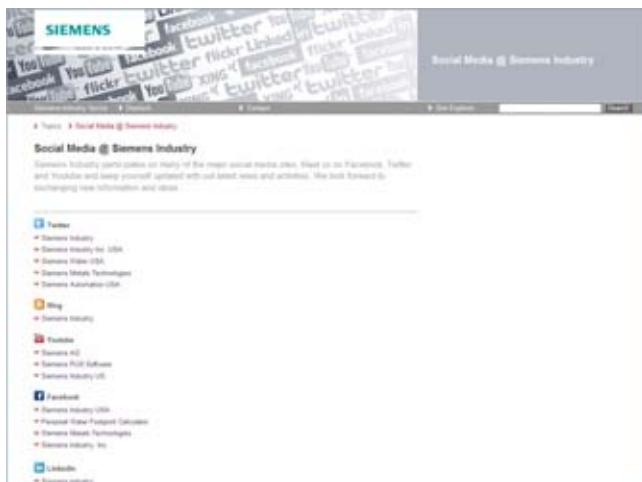

Connect with Siemens through social media: visit our social networking sites for a wealth of useful information, demos on products and services, the opportunity to provide feedback, to exchange information and ideas with customers and other Siemens employees, and much, much more. Stay in the know and follow us on the ever-expanding global network of social media.

Connect with Siemens Industry at our central access point:

www.siemens.com/industry/socialmedia

Or via our product pages at:

www.siemens.com/automation

or

www.siemens.com/drives

To find out more about Siemens' current social media activities visit us at:

www.siemens.com/socialmedia

Mobile Media



Discover the world of Siemens.

We are also constantly expanding our offering of cross-platform apps for smartphones and tablets. You will find the current Siemens apps at the app store (iOS) or at Google Play (Android).

The Siemens app, for example, tells you all about the history, latest developments and future plans of the company – with informative pictures, fascinating reports and the most recent press releases.

A	
Accessories for IMS (Inverter Management Software)	4/3
Additional boards for bus connection	4/5
Additional cabinets for cabinet units	4/31
Ambient temperature for air-cooled converters	4/31
Application	1/5
Article number code	
• Compact units	2/17
• Cabinet units air-cooled and liquid-cooled	3/48
• Cabinet systems	2/60
Article number index	7/9
Auxiliary power supply	4/2
B	
Benefits	1/5
Board for mains supply backup	4/5
Braking chopper	4/19
Bus connection, additional boards	4/5
C	
CA 01	7/3
Cabinet options	4/23
Cabinet systems	2/28
• Selection and ordering data	2/29
- 400 V, 6-pulse	2/29
- 500 V, 6-pulse	2/29
- 690 V, 6-pulse	2/30
- Article number code	2/31
- Number code for converter type	2/31
• Options	2/32
- 400 V TN/TT system	2/32
- 500 V IT system	2/32
- 690 V IT system	2/39
- 690 V TN/TT system	2/39
Cabinet units air-cooled	3/57
• Selection and ordering data	3/57
- 400 V, 6-pulse	3/57
- 400 V, 12-pulse	3/57
- 500 V, 6-pulse	3/58
- 500 V, 12-pulse	3/58
- 690 V, 6-pulse	3/59
- 690 V, 12-pulse	3/60
- 690 V, 18-pulse	3/60
- 690 V, 24-pulse	3/61
• Dimensional drawings	3/62
- Frame size SL2	3/62
- Frame size SL3	3/64
- Frame size SL4	3/65
- Frame size SL5	3/66
- Frame size SL6	3/67
- Frame size SL7	3/68
- Frame size SL8	3/69
- Frame size SL9	3/70
- Frame size SL10	3/71
- Frame size SL11	3/72
- Frame size SL12	3/73
- Frame size SL21	3/63
Cabinet units air-cooled and liquid-cooled	3/2
• Selection and ordering data	3/48
- Article number code	3/48
- Number code for converter type	3/49
• Options	3/50
• Technical data	3/3
- General technical data	3/4
- 400 V, 6-pulse	3/6
- 400 V, 12-pulse	3/10
- 500 V, 6-pulse	3/14
- 500 V, 12-pulse	3/18
- 690 V, 6-pulse	3/22
- 690 V, 12-pulse	3/28
- 690 V, 18-pulse	3/38
- 690 V, 24-pulse	3/42
Cabinet units liquid-cooled	3/74
• Selection and ordering data	3/76
- 400 V, 6-pulse	3/76
- 400 V, 12-pulse	3/76
- 500 V, 6-pulse	3/77
- 500 V, 12-pulse	3/77
- 690 V, 6-pulse	3/78
- 690 V, 12-pulse	3/79
- 690 V, 18-pulse	3/79
- 690 V, 24-pulse	3/80
• Dimensional drawings	3/81
- Frame size SW2	3/81
- Frame size SW3	3/83
- Frame size SW4	3/84
- Frame size SW5	3/85
- Frame size SW6	3/86
- Frame size SW7	3/87
- Frame size SW8	3/88
- Frame size SW9	3/89
- Frame size SW10	3/90
- Frame size SW21	3/82
Cabinet widths for cabinet systems with compact units	4/31
Cable cross-sections	5/8
Cable cross-sections for line and motor connections	5/14
CALOMAT CK145	4/19
Catalog CA 01 of Industry	7/3
Characteristic curves	5/5
• Derating data	5/5
• Overload capability	5/7
Closed-loop control functions	5/2
Commissioning of SINAMICS G180	6/3
Communication	1/6
Communication possibilities	5/18
Communication with higher-level control and customer terminal strip	5/2
Compact units	2/2
• General technical data	2/3
• Selection and ordering data	2/15
- 400 V, 6-pulse	2/15
- 500 V, 6-pulse	2/15
- 690 V, 6-pulse	2/16
- Article number code	2/17
- Number code for converter type	2/17
• Dimensional drawings	2/21
- Frame size K1	2/21
- Frame size K2	2/22
- Frame size K3	2/23
- Frame size K4	2/24
- Frame size K5	2/25
- Frame size K6	2/27
- Frame size K51	2/26
• Compact units, standards	2/2
• Compact units, options	2/18
- 400 V TN/TT system	2/18
- 500 V IT system	2/18
- 690 V IT system	2/18
- 690 V TN/TT system	2/18
• Technical data	2/2
- 400 V, 6-pulse	2/4
- 500 V, 6-pulse	2/8
- 690 V, 6-pulse	2/12
• Manual	6/8
Condition Monitoring	6/14
Conditions of delivery	7/14
Conditions of sale	7/14
Connections	5/8
Control elements in control cabinet door	4/13

Subject index

C (continued)

Control section.....	1/5
Control voltage supply, external.....	4/2
Converter display language (language 1/language 2).....	4/30
Converter documentation.....	4/3, 6/8
Coolant.....	3/5
• Permissible substance values for the coolant.....	3/5
• Cooling water additives for the closed converter cooling system with cooling unit.....	3/5
Customer terminal strip.....	5/2
Customer training.....	6/2

D

Degrees of protection.....	4/26
Derating data.....	5/5
Design.....	1/5
Development of a well-proven product.....	1/2
Dimensional drawings	
• Compact units.....	2/21
- Frame size K1.....	2/21
- Frame size K2.....	2/22
- Frame size K3.....	2/23
- Frame size K4.....	2/24
- Frame size K5.....	2/25
- Frame size K6.....	2/27
- Frame size K51.....	2/26
• Cabinet units air-cooled.....	3/62
- Frame size SL2.....	3/62
- Frame size SL3.....	3/64
- Frame size SL4.....	3/65
- Frame size SL5.....	3/66
- Frame size SL6.....	3/67
- Frame size SL7.....	3/68
- Frame size SL8.....	3/69
- Frame size SL9.....	3/70
- Frame size SL10.....	3/71
- Frame size SL11.....	3/72
- Frame size SL12.....	3/73
- Frame size SL21.....	3/63
• Cabinet units liquid-cooled.....	3/81
- Frame size SW2.....	3/81
- Frame size SW3.....	3/83
- Frame size SW4.....	3/84
- Frame size SW5.....	3/85
- Frame size SW6.....	3/86
- Frame size SW7.....	3/87
- Frame size SW8.....	3/88
- Frame size SW9.....	3/89
- Frame size SW10.....	3/90
- Frame size SW21.....	3/82
Display instruments in control cabinet door.....	4/13
Documentation.....	6/8
Drive behavior.....	1/6
DT Configurator selection guide.....	5/22

E

Energy & Environmental Services.....	6/14
Engineer To Order – ETO.....	4/34
Engineering.....	4/34
Engineering Support.....	6/13
Environmental Services.....	6/14
ETO (Engineered to Order).....	1/2
ETO converters, manual.....	6/8
Evaluation unit Pt100.....	4/21
Explosion protection.....	1/5
Explosion-proof drives.....	1/3
Extension of the liability for defects.....	4/28
External control voltage supply.....	4/2

F

Field Services.....	6/12
Function.....	1/5
Functions.....	5/2

G

General.....	1/6
General information about customer training.....	6/2
General technical data, cabinet units air-cooled and liquid-cooled.....	3/4
General technical data, compact units.....	2/3
Gost-R certificate.....	4/30
Grounding.....	5/15

I

IMS (Inverter Management Software), Accessories.....	4/3
IMS commissioning tool.....	5/24
Industry Mall.....	7/3
Industry Services for the entire life cycle.....	6/10
Information and Download Center.....	7/4
Information in the Internet and on DVD.....	7/3
Information on DVD.....	7/3
Inputs/outputs, NAMUR-compliant.....	5/17
Inspection options.....	4/32
Inspections for converters.....	4/32
Installation altitude.....	4/31
Insulation monitoring.....	4/20
Interactive Catalog CA 01 of Industry.....	7/3
Internet - Information.....	7/3
Internet - Ordering.....	7/3

L

Label for plant identification.....	4/30
Language of manual.....	4/31
Language (language 1/language 2), converter display.....	4/30
Liability for defects.....	4/28
Line connection.....	5/14
Line Harmonics Filter.....	4/15
Line voltages.....	4/31

M

Mains supply backup, board.....	4/5
Maintenance and inspection of converters.....	6/4
Manual.....	4/31, 6/8
Marking of cable cores.....	4/4
Marking of items of equipment.....	4/4
Metal surcharges.....	7/11
Mobile Media.....	7/4
Modernization & Optimization Services.....	6/16
Motor connection.....	5/14

N

NAMUR.....	5/17
NAMUR-compliant assignment of inputs/outputs.....	5/17
Number code for converter type	
• Compact units.....	2/17
• Cabinet units air-cooled and liquid-cooled.....	3/49
• Cabinet systems.....	2/31

O	
Offline access in the electronic catalog CA 01.....	5/23
Online access in the Siemens Mall.....	5/23
Online Services.....	7/3
Online Support.....	6/10
Open-loop and closed-loop control functions.....	5/2
Operation.....	1/5
Optimization Services.....	6/16
Option descriptions.....	4/2
• ETO options.....	4/34
• Inspection options.....	4/32
• Standard options.....	4/2
Options.....	
• Compact units.....	2/18
- 400 V TN/TT system.....	2/18
- 500 V IT system.....	2/18
- 690 V IT system.....	2/18
- 690 V TN/TT system.....	2/18
• Cabinet units air-cooled and liquid-cooled.....	3/50
• Cabinet systems.....	2/32
- 400 V TN/TT system.....	2/32
- 500 V IT system.....	2/32
- 690 V IT system.....	2/39
- 690 V TN/TT system.....	2/39
Ordering in the Internet and on DVD.....	7/3
Ordering on DVD.....	7/3
Output filter.....	4/16
Overload capability.....	5/7
Overview.....	1/2
Overview of data for SINAMICS G180 compact units, cabinet systems and cabinet units.....	1/6
P	
Partners at Industry Automation and Drive Technologies.....	7/2
PE conductor cross-section.....	5/15
Peripheral boards 1 to 4.....	4/7
Plant identification, label.....	4/30
Plant Maintenance & Condition Monitoring.....	6/14
Platform concept.....	1/5
Power unit.....	1/5
Production flowchart.....	4/2
Protective functions.....	5/2
Pt100 evaluation unit.....	4/21
Q	
Quality management to DIN EN ISO 9001.....	1/6
R	
Remote maintenance – Expert knowledge close at hand.....	6/7
Repair Services.....	6/11
Repairs at Headquarters.....	6/5
Required cable cross-sections for line and motor connections.....	5/14
RFI suppression filter.....	4/15
S	
Safe Torque Off.....	1/5
Safety Integrated functions.....	5/3
Selection and ordering data.....	
• Compact units.....	2/15
- 400 V, 6-pulse.....	2/15
- 500 V, 6-pulse.....	2/15
- 690 V, 6-pulse.....	2/16
- Article number code.....	2/17
- Number code for converter type.....	2/17
• Cabinet units air-cooled.....	3/57
- 400 V, 6-pulse.....	3/57
- 400 V, 12-pulse.....	3/57
- 500 V, 6-pulse.....	3/58
- 500 V, 12-pulse.....	3/58
- 690 V, 6-pulse.....	3/59
- 690 V, 12-pulse.....	3/60
- 690 V, 18-pulse.....	3/60
- 690 V, 24-pulse.....	3/61
• Cabinet units air-cooled and liquid-cooled.....	3/48
- Article number code.....	3/48
- Number code for converter type.....	3/49
• Cabinet units liquid-cooled.....	3/76
- 400 V, 6-pulse.....	3/76
- 400 V, 12-pulse.....	3/76
- 500 V, 6-pulse.....	3/77
- 500 V, 12-pulse.....	3/77
- 690 V, 6-pulse.....	3/78
- 690 V, 12-pulse.....	3/79
- 690 V, 18-pulse.....	3/79
- 690 V, 24-pulse.....	3/80
• Cabinet systems.....	2/29
- 400 V, 6-pulse.....	2/29
- 500 V, 6-pulse.....	2/29
- 690 V, 6-pulse.....	2/30
- Article number code.....	2/31
- Number code for converter type.....	2/31
Service & Support.....	6/9
Service at Headquarters.....	6/6
Service Contracts.....	6/15
Services.....	6/4
Services.....	6/7
Settings.....	1/5
Siemens Industry Automation and Drive Technologies in the WWW.....	7/3
SINAMICS G180.....	1/4
• Compact units.....	2/2
• Cabinet units air-cooled and liquid-cooled.....	3/2
• Cabinet units air-cooled.....	3/57
• Cabinet units liquid-cooled.....	3/74
• Cabinet systems.....	2/28
SINAMICS G180 customer training.....	6/2
SIZER for Siemens Drives engineering tool.....	5/21
Social Media.....	7/4
Software and protective functions.....	5/2
Spare Parts.....	6/10
Spare parts for SINAMICS G180 converters.....	6/6
Spare parts information and database.....	6/6
Spare parts packages on site.....	6/6
Spare parts price list.....	4/2
Standard accessories packages.....	4/29
Standard assignment of inputs/outputs.....	5/17
Standard interface.....	5/16
Standard options.....	4/2
Standards for cabinet units.....	3/3
Standards for compact units.....	2/2
Support, Service.....	6/9

Subject index

T

Technical Consulting & Engineering Support	6/13
Technical data	
• Compact units	2/2
- General technical data	2/3
- 400 V, 6-pulse	2/4
- 500 V, 6-pulse	2/8
- 690 V, 6-pulse	2/12
• Cabinet units air-cooled and liquid-cooled	3/2
- General technical data	3/4
- 400 V, 6-pulse	3/6
- 400 V, 12-pulse	3/10
- 500 V, 6-pulse	3/14
- 500 V, 12-pulse	3/18
- 690 V, 6-pulse	3/22
- 690 V, 12-pulse	3/28
- 690 V, 18-pulse	3/38
- 690 V, 24-pulse	3/42
Technical data – Overview of data for compact units, cabinet systems, cabinet units	1/6
Technical Support	6/10
Test sequence schedule	4/2
Training	6/13
Type plate	5/19

W

Water inlet temperature for liquid-cooled converters	4/31
Water Related Services.....	6/16
Wiring options	4/28
WWW - Siemens Industry Automation and Drive Technologies	7/3

Z

ZLU - Supplementary Supply Agreements for Converter Drives in Power Plants	5/20
---	------

6SE0100

6SE0100-1AC..-....	2/15
6SE0100-1AD..-....	2/15
6SE0100-1AG..-....	2/16
6SE0100-1AH..-....	2/16

6SE0140

6SE0140-1.C..-....	2/29
6SE0140-1.D..-....	2/29
6SE0140-1.G..-....	2/30
6SE0140-1.H..-....	2/30

6SE0170

6SE0170-1BA..-....	3/76
6SE0170-1BD..-....	3/77
6SE0170-1BG..-....	3/78
6SE0170-1BH..-....	3/78
6SE0170-1CG..-....	3/78
6SE0170-1CH..-....	3/78
6SE0170-2BA..-....	3/76
6SE0170-2BD..-....	3/77
6SE0170-2BH..-....	3/79
6SE0170-2CH..-....	3/79
6SE0170-2DH..-....	3/79
6SE0170-2EH..-....	3/79
6SE0170-3DH..-....	3/79
6SE0170-3HH..-....	3/79
6SE0170-4CH..-....	3/80
6SE0170-4EH..-....	3/80
6SE0170-4HH..-....	3/80

6SE0180

6SE0180-1BA..-....	3/57
6SE0180-1BD..-....	3/58
6SE0180-1BG..-....	3/59
6SE0180-1BH..-....	3/59
6SE0180-1CG..-....	3/59
6SE0180-1CH..-....	3/59
6SE0180-2BA..-....	3/57
6SE0180-2BD..-....	3/58
6SE0180-2BH..-....	3/60
6SE0180-2CH..-....	3/60
6SE0180-2DH..-....	3/60
6SE0180-2EH..-....	3/60
6SE0180-3DH..-....	3/60
6SE0180-3HH..-....	3/60
6SE0180-4CH..-....	3/61
6SE0180-4EH..-....	3/61
6SE0180-4HH..-....	3/61

6SL3070

6SL3070-0AA00-0AGO	5/21
--------------------------	------

SINAMICS G180

Appendix

Notes

Explanation of the raw material/metal surcharges¹⁾

Surcharge calculation

To compensate for variations in the price of the raw materials silver, copper, aluminum, lead, gold, dysprosium²⁾ and/or neodym²⁾, surcharges are calculated on a daily basis using the so-called metal factor for products containing these raw materials. A surcharge for the respective raw material is calculated as a supplement to the price of a product if the basic official price of the raw material in question is exceeded.

The surcharges are calculated in accordance with the following criteria:

- Basic official price of the raw material
Basic official price from the day prior to receipt of the order or prior to release order (daily price) for³⁾
 - Silver (sales price, processed)
 - Gold (sales price, processed)
 and for⁴⁾
 - Copper (lower DEL notation + 1 %)
 - Aluminum (aluminum in cables)
 - Lead (lead in cables)
- Metal factor of the products
Certain products are displayed with a metal factor. The metal factor determines the official price (for those raw materials concerned) as of which the metal surcharges are applied and the calculation method used (weight or percentage method). An exact explanation is given below.

Structure of the metal factor

The metal factor consists of several digits; the first digit indicates whether the percentage method of calculation refers to the list price or a possible discounted price (customer net price) (L = list price / N = customer net price).

The remaining digits indicate the method of calculation used for the respective raw material. If no surcharge is added for a raw material, a "-" is used.

1st digit	List or customer net price using the percentage method
2nd digit	for silver (AG)
3rd digit	for copper (CU)
4th digit	for aluminum (AL)
5th digit	for lead (PB)
6th digit	for gold (AU)
7th digit	for dysprosium (Dy) ²⁾
8th digit	for neodym (Nd) ²⁾

Weight method

The weight method uses the basic official price, the daily price and the raw material weight. In order to calculate the surcharge, the basic official price must be subtracted from the daily price. The difference is then multiplied by the raw material weight.

The basic official price can be found in the table below using the number (1 to 9) of the respective digit of the metal factor. The raw material weight can be found in the respective product descriptions.

Percentage method

Use of the percentage method is indicated by the letters A-Z at the respective digit of the metal factor.

The surcharge is increased - dependent on the deviation of the daily price compared with the basic official price - using the percentage method in "steps" and consequently offers surcharges that remain constant within the framework of this "step range". A higher percentage rate is charged for each new step. The respective percentage level can be found in the table below.

Metal factor examples

L E A - - - - -	<ul style="list-style-type: none"> Basis for % surcharge: List price Silver Basis 150 €, Step 50 €, 0.5 % Copper Basis 150 €, Step 50 €, 0.1 % No surcharge for aluminum No surcharge for lead No surcharge for gold No surcharge for dysprosium No surcharge for neodym
N - A 6 - - - - -	<ul style="list-style-type: none"> Basis for % surcharge: Customer net price No surcharge for silver Copper Basis 150 €, Step 50 €, 0.1 % Aluminum acc. to weight, basic offic. price 225 € No surcharge for lead No surcharge for gold No surcharge for dysprosium No surcharge for neodym
- - 3 - - - - -	<ul style="list-style-type: none"> No basis necessary No surcharge for silver Copper acc. to weight, basic official price 150 € No surcharge for aluminum No surcharge for lead No surcharge for gold No surcharge for dysprosium No surcharge for neodym

¹⁾ Refer to the separate explanation on the next page regarding the raw materials dysprosium and neodym (= rare earths).

²⁾ For a different method of calculation, refer to the separate explanation for these raw materials on the next page.

³⁾ Source: Umicore, Hanau (www.metalsmanagement.umicore.com).

⁴⁾ Source: German Trade Association for Cables and Conductors (www.kabelverband.org).

Explanation of the raw material/metal surcharges for dysprosium and neodym (rare earths)**Surcharge calculation**

To compensate for variations in the price of the raw materials silver¹⁾, copper¹⁾, aluminum¹⁾, lead¹⁾, gold¹⁾, dysprosium and/or neodym, surcharges are calculated on a daily basis using the so-called metal factor for products containing these raw materials. The surcharge for dysprosium and neodym is calculated as a supplement to the price of a product if the basic official price of the raw material in question is exceeded.

The surcharge is calculated in accordance with the following criteria:

- Basic official price of the raw material²⁾
Three-month basic average price (see below) in the period before the quarter in which the order was received or the release order took place (= average official price) for
 - dysprosium (Dy metal, 99 % min. FOB China; USD/kg)
 - neodym (Nd metal, 99 % min. FOB China; USD/kg)
- Metal factor of the products
Certain products are displayed with a metal factor. The metal factor indicates (for those raw materials concerned) the basic official price as of which the surcharges for dysprosium and neodym are calculated using the weight method. An exact explanation of the metal factor is given below.

Three-month average price

The prices of rare earths vary according to the foreign currency, and there is no freely accessible stock exchange listing. This makes it more difficult for all parties involved to monitor changes in price. In order to avoid continuous adjustment of the surcharges, but to still ensure fair, transparent pricing, an average price is calculated over a three-month period using the average monthly foreign exchange rate from USD to EUR (source: European Central Bank). Since not all facts are immediately available at the start of each month, a one-month buffer is allowed before the new average price applies.

Examples of calculation of the average official price:

Period for calculation of the average price:	Period during which the order/release order is effected and the average price applies:
Sep 2012 - Nov 2012	Q1 in 2013 (Jan - Mar)
Dec 2012 - Feb 2013	Q2 in 2013 (Apr - Jun)
Mar 2013 - May 2013	Q3 in 2013 (Jul - Sep)
Jun 2013 - Aug 2013	Q4 in 2013 (Oct - Dec)

Structure of the metal factor

The metal factor consists of several digits; the first digit is not relevant to the calculation of dysprosium and neodym.

The remaining digits indicate the method of calculation used for the respective raw material. If no surcharge is added for a raw material, a "-" is used.

1st digit	List or customer net price using the percentage method
2nd digit	for silver (AG) ¹⁾
3rd digit	for copper (CU) ¹⁾
4th digit	for aluminum (AL) ¹⁾
5th digit	for lead (PB) ¹⁾
6th digit	for gold (AU) ¹⁾
7th digit	for dysprosium (Dy)
8th digit	for neodym (Nd)

Weight method

The weight method uses the basic official price, the average price and the raw material weight. In order to calculate the surcharge, the basic official price must be subtracted from the average price. The difference is then multiplied by the raw material weight.

The basic official price can be found in the table below using the number (1 to 9) of the respective digit of the metal factor. Your Sales contact can inform you of the raw material weight.

Metal factor examples

-----71	
↑	No basis necessary
↑	No surcharge for silver
↑	No surcharge for copper
↑	No surcharge for aluminum
↑	No surcharge for lead
↑	No surcharge for gold
↑	Dysprosium acc. to weight, basic official price 300 €
↑	Neodym acc. to weight, basic official price 50 €

¹⁾ For a different method of calculation, refer to the separate explanation for these raw materials on the previous page.

²⁾ Source: Asian Metal Ltd (www.asianmetal.com)

Values of the metal factor

Percentage method	Basic official price in €	Step range in €	% surcharge 1st step	% surcharge 2nd step	% surcharge 3rd step	% surcharge 4th step	% surcharge per additional step	
			Price in € 150.01 - 200.00	Price in € 200.01 - 250.00	Price in € 250.01 - 300.00	Price in € 300.01 - 350.00		
A	150	50	0.1	0.2	0.3	0.4	0.1	
B	150	50	0.2	0.4	0.6	0.8	0.2	
C	150	50	0.3	0.6	0.9	1.2	0.3	
D	150	50	0.4	0.8	1.2	1.6	0.4	
E	150	50	0.5	1.0	1.5	2.0	0.5	
F	150	50	0.6	1.2	1.8	2.4	0.6	
G	150	50	1.0	2.0	3.0	4.0	1.0	
H	150	50	1.2	2.4	3.6	4.8	1.2	
I	150	50	1.6	3.2	4.8	6.4	1.6	
J	150	50	1.8	3.6	5.4	7.2	1.8	
			175.01 - 225.00	225.01 - 275.00	275.01 - 325.00	325.01 - 375.00		
O	175	50	0.1	0.2	0.3	0.4	0.1	
P	175	50	0.2	0.4	0.6	0.8	0.2	
R	175	50	0.5	1.0	1.5	2.0	0.5	
			225.01 - 275.00	275.01 - 325.00	325.01 - 375.00	375.01 - 425.00		
S	225	50	0.2	0.4	0.6	0.8	0.2	
U	225	50	1.0	2.0	3.0	4.0	1.0	
V	225	50	1.0	1.5	2.0	3.0	1.0	
W	225	50	1.2	2.5	3.5	4.5	1.0	
			150.01 - 175.00	175.01 - 200.00	200.01 - 225.00	225.01 - 250.00		
Y	150	25	0.3	0.6	0.9	1.2	0.3	
			400.01 - 425.00	425.01 - 450.00	450.01 - 475.00	475.01 - 500.00		
Z	400	25	0.1	0.2	0.3	0.4	0.1	
Price basis (1st digit)								
L	Calculation based on the list price							
N	Calculation based on the customer net price (discounted list price)							
Weight method	Basic official price in €							
1	50	Calculation based on raw material weight						
2	100							
3	150							
4	175							
5	200							
6	225							
7	300							
8	400							
9	555							
Miscellaneous								
-	No metal surcharge							

Conditions of sale and delivery

1. General Provisions

By using this catalog you can acquire hardware and software products described therein from Siemens AG subject to the following Terms and Conditions of Sale and Delivery (hereinafter referred to as "T&C"). Please note that the scope, the quality and the conditions for supplies and services, including software products, by any Siemens entity having a registered office outside Germany, shall be subject exclusively to the General Terms and Conditions of the respective Siemens entity. The following T&C apply exclusively for orders placed with Siemens Aktiengesellschaft, Germany.

1.1 For customers with a seat or registered office in Germany

For customers with a seat or registered office in Germany, the following applies subordinate to the T&C:

- the "General Terms of Payment"¹⁾ and,
- for software products, the "General License Conditions for Software Products for Automation and Drives for Customers with a Seat or Registered Office in Germany"¹⁾ and,
- for other supplies and services, the "General Conditions for the Supply of Products and Services of the Electrical and Electronics Industry"¹⁾.

1.2 For customers with a seat or registered office outside Germany

For customers with a seat or registered office outside Germany, the following applies subordinate to the T&C:

- the "General Terms of Payment"¹⁾ and,
- for software products, the "General License Conditions for Software Products for Automation and Drives for Customers with a Seat or Registered Office outside of Germany"¹⁾ and
- for other supplies and/or services, the "General Conditions for Supplies of Siemens Industry for Customers with a Seat or Registered Office outside of Germany"¹⁾.

2. Prices

The prices are in € (Euro) ex point of delivery, exclusive of packaging.

The sales tax (value added tax) is not included in the prices. It shall be charged separately at the respective rate according to the applicable statutory legal regulations.

Prices are subject to change without prior notice. We will charge the prices valid at the time of delivery.

To compensate for variations in the price of raw materials (e.g. silver, copper, aluminum, lead, gold, dysprosium and neodym), surcharges are calculated on a daily basis using the so-called metal factor for products containing these raw materials. A surcharge for the respective raw material is calculated as a supplement to the price of a product if the basic official price of the raw material in question is exceeded.

The metal factor of a product indicates the basic official price (for those raw materials concerned) as of which the surcharges on the price of the product are applied, and with what method of calculation.

You will find a detailed explanation of the metal factor on the page headed "Metal surcharges".

To calculate the surcharge (except in the cases of dysprosium and neodym), the official price from the day prior to that on which the order was received or the release order was effected is used.

To calculate the surcharge applicable to dysprosium and neodym ("rare earths"), the corresponding three-month basic average price in the quarter prior to that in which the order was received or the release order was effected is used with a one-month buffer (details on the calculation can be found in the explanation of the metal factor).

3. Additional Terms and Conditions

The dimensions are in mm. In Germany, according to the German law on units in measuring technology, data in inches apply only to devices for export.

Illustrations are not binding.

Insofar as there are no remarks on the individual pages of this catalog - especially with regard to data, dimensions and weights given - these are subject to change without prior notice.

4. Export regulations

We shall not be obligated to fulfill any agreement if such fulfillment is prevented by any impediments arising out of national or international foreign trade or customs requirements or any embargoes and/or other sanctions.

Export of goods listed in this catalog may be subject to licensing requirements. We will indicate in the delivery details whether licenses are required under German, European and US export lists. Goods labeled with "AL" not equal to "N" are subject to European or German export authorization when being exported out of the EU. Goods labeled with "ECCN" not equal to "N" are subject to US re-export authorization.

The export indications can be viewed in advance in the description of the respective goods on the Industry Mall, our online catalog system. Only the export labels "AL" and "ECCN" indicated on order confirmations, delivery notes and invoices are authoritative.

Even without a label, or with label "AL:N" or "ECCN:N", authorization may be required i.a. due to the final disposition and intended use of goods.

If you transfer goods (hardware and/or software and/or technology as well as corresponding documentation, regardless of the mode of provision) delivered by us or works and services (including all kinds of technical support) performed by us to a third party worldwide, you must comply with all applicable national and international (re-)export control regulations.

If required for the purpose of conducting export control checks, you (upon request by us) shall promptly provide us with all information pertaining to the particular end customer, final disposition and intended use of goods delivered by us respectively works and services provided by us, as well as to any export control restrictions existing in this relation.

The products listed in this catalog may be subject to European/German and/or US export regulations. Any export requiring approval is therefore subject to authorization by the relevant authorities.

Errors excepted and subject to change without prior notice.

¹⁾ The text of the Terms and Conditions of Siemens AG can be downloaded at www.siemens.com/automation/salesmaterial-as/catalog/en/terms_of_trade_en.pdf

Industry Automation, Drive Technologies and Low-Voltage Power Distribution

Further information can be obtained from our branch offices listed at www.siemens.com/automation/partner

System Solutions for Industry Interactive Catalog on DVD	<i>Catalog</i>		
Products for Automation and Drives, Low-Voltage Power Distribution and Electrical Installation Technology	CA 01		
Building Control			
GAMMA Building Control	ET G1		
Drive Systems			
SINAMICS G130 Drive Converter Chassis Units	D 11		
SINAMICS G150 Drive Converter Cabinet Units			
SINAMICS GM150, SINAMICS SM150 Medium-Voltage Converters	D 12		
SINAMICS PERFECT HARMONY GH180 Medium-Voltage Air-Cooled Drives Germany Edition	D 15.1		
SINAMICS G180 Converters – Compact Units, Cabinet Systems, Cabinet Units Air-Cooled and Liquid-Cooled	D 18.1		
SINAMICS S120 Chassis Format Units and Cabinet Modules	D 21.3		
SINAMICS S150 Converter Cabinet Units			
SINAMICS DCM Converter Units	D 23.1		
SINAMICS DCM Cabinet	D 23.2		
SINAMICS and Motors for Single-Axis Drives	D 31		
Three-Phase Induction Motors SIMOTICS HV, SIMOTICS TN	D 84.1		
• Series H-compact			
• Series H-compact PLUS			
Asynchronous Motors Standardline	D 86.1		
Synchronous Motors with Permanent-Magnet Technology, HT-direct	D 86.2		
DC Motors	DA 12		
SIMOREG DC MASTER 6RA70 Digital Chassis Converters	DA 21.1		
SIMOREG K 6RA22 Analog Chassis Converters	DA 21.2		
<i>Digital: SIMOREG DC MASTER 6RM70 Digital Converter Cabinet Units</i>	DA 22		
SIMOVERT PM Modular Converter Systems	DA 45		
SIEMOSYN Motors	DA 48		
MICROMASTER 420/430/440 Inverters	DA 51.2		
MICROMASTER 411/COMBIMASTER 411	DA 51.3		
SIMOVERT MASTERDRIVES Vector Control	DA 65.10		
SIMOVERT MASTERDRIVES Motion Control	DA 65.11		
Synchronous and asynchronous servomotors for SIMOVERT MASTERDRIVES	DA 65.3		
SIMODRIVE 611 universal and POSMO	DA 65.4		
<i>Note: Additional catalogs on SIMODRIVE or SINAMICS drive systems and SIMOTICS motors with SINUMERIK and SIMOTION can be found under Motion Control</i>			
<u>Low-Voltage Three-Phase-Motors</u>			
SIMOTICS Low-Voltage Motors	D 81.1		
MOTOX Geared Motors	D 87.1		
SIMOGEAR Geared Motors	MD 50.1		
SIMOGEAR Gearboxes with adapter	MD 50.11		
<u>Mechanical Driving Machines</u>			
FLENDER Standard Couplings	MD 10.1		
FLENDER High Performance Couplings	MD 10.2		
FLENDER SIG Standard industrial gear unit	MD 30.1		
FLENDER SIP Standard industrial planetary gear units	MD 31.1		
Process Instrumentation and Analytics			
Field Instruments for Process Automation	FI 01		
<i>Digital: SIPART Controllers and Software</i>	MP 31		
Products for Weighing Technology	WT 10		
<i>Digital: Process Analytical Instruments</i>	PA 01		
<i>Digital: Process Analytics, Components for the System Integration</i>	PA 11		
<i>Digital: These catalogs are only available as a PDF and/or as an e-book.</i>			
Low-Voltage Power Distribution and Electrical Installation Technology	<i>Catalog</i>		
SENTRON · SIVACON · ALPHA Protection, Switching, Measuring and Monitoring Devices, Switchboards and Distribution Systems	LV 10		
Standards-Compliant Components for Photovoltaic Plants	LV 11		
3WT Air Circuit Breakers up to 4000 A	LV 35		
<i>Digital: 3VT Molded Case Circuit Breakers up to 1600 A</i>	LV 36		
<i>Digital: SIVACON System Cubicles, System Lighting and System Air-Conditioning</i>	LV 50		
<i>Digital: ALPHA Distribution Systems</i>	LV 51		
ALPHA FIX Terminal Blocks	LV 52		
SIVACON S4 Power Distribution Boards	LV 56		
<i>Digital: SIVACON 8PS Busbar Trunking Systems</i>	LV 70		
<i>Digital: DELTA Switches and Socket Outlets</i>	ET D1		
Motion Control			
SINUMERIK & SIMODRIVE Automation Systems for Machine Tools	NC 60		
SINUMERIK & SINAMICS Equipment for Machine Tools	NC 61		
SINUMERIK 840D sl Type 1B Equipment for Machine Tools	NC 62		
SINUMERIK 808 Equipment for Machine Tools	NC 81.1		
SINUMERIK 828 Equipment for Machine Tools	NC 82		
SIMOTION, SINAMICS S120 & SIMOTICS Equipment for Production Machines	PM 21		
Drive and Control Components for Cranes	CR 1		
Power Supply			
Power supply SITOP	KT 10.1		
Safety Integrated			
Safety Technology for Factory Automation	SI 10		
SIMATIC HMI/PC-based Automation			
Human Machine Interface Systems/PC-based Automation	ST 80/ ST PC		
SIMATIC Ident			
Industrial Identification Systems	ID 10		
SIMATIC Industrial Automation Systems			
Products for Totally Integrated Automation	ST 70		
SIMATIC PCS 7 Process Control System System components	ST PCS 7		
SIMATIC PCS 7 Process Control System Technology components	ST PCS 7 T		
Add-ons for the SIMATIC PCS 7 Process Control System	ST PCS 7 AO		
SIMATIC NET			
Industrial Communication	IK PI		
SIRIUS Industrial Controls			
SIRIUS Industrial Controls	IC 10		
Information and Download Center			
Digital versions of the catalogs are available on the Internet at: www.siemens.com/industry/infocenter			
There you'll find additional catalogs in other languages.			
Please note the section "Downloading catalogs" on page "Online services" in the appendix of this catalog.			

Get more information

The drives family SINAMICS:
www.siemens.com/sinamics

SINAMICS G180
Converters – Compact Units, Cabinet Systems,
Cabinet Units Air-Cooled and Liquid-Cooled:
www.siemens.com/sinamics-g180

Local partners worldwide:
www.siemens.com/automation/partner

Siemens AG
Industry Sector
Drive Technologies Division
Large Drives
Hans-Loher-Str. 32
94099 RUHSTORF A. D. ROTT
GERMANY

Subject to change without prior notice
Article No. E86060-K5518-A111-A2-7600
E.9115.45.LDT / Dispo 18402
KG 0314 2.0 PAS 240 En
Printed in Germany
© Siemens AG 2014

The information provided in this catalog contains merely general descriptions or characteristics of performance which in case of actual use do not always apply as described or which may change as a result of further development of the products. An obligation to provide the respective characteristics shall only exist if expressly agreed in the terms of contract. Availability and technical specifications are subject to change without notice.
All product designations may be trademarks or product names of Siemens AG or supplier companies whose use by third parties for their own purposes could violate the rights of the owners.

www.siemens.com/drives

Token fee: 5.00 €